

Programmer Manual



RSA3303A & RSA3308A 3 GHz & 8 GHz Real-Time Spectrum Analyzers 071-1411-02

This document applies to firmware version 3.0
and above.

www.tektronix.com

Copyright © Tektronix Japan, Ltd. All rights reserved.

Copyright © Tektronix, Inc. All rights reserved.

Licensed software products are owned by Tektronix or its suppliers and are protected by United States copyright laws and international treaty provisions.

Use, duplication, or disclosure by the Government is subject to restrictions as set forth in subparagraph (c)(1)(ii) of the Rights in Technical Data and Computer Software clause at DFARS 252.227-7013, or subparagraphs (c)(1) and (2) of the Commercial Computer Software – Restricted Rights clause at FAR 52.227-19, as applicable.

Tektronix products are covered by U.S. and foreign patents, issued and pending. Information in this publication supercedes that in all previously published material. Specifications and price change privileges reserved.

Tektronix Japan, Ltd., Shinagawa Intercity Building B 6th Floor, 2-15-2 Konan, Minato-ku, Tokyo 108-6106 Japan
Tektronix, Inc., P.O. Box 500, Beaverton, OR 97077

TEKTRONIX and TEK are registered trademarks of Tektronix, Inc.

Windows and Windows XP are trademarks of Microsoft Corporation.

Table of Contents

Preface	ix
Related Manual	ix
Difference between RSA3303A and RSA3308A	ix

Getting Started

Overview of the Manual	1-2
Connecting the Interface	1-4
Using the GPIB Port	1-5
Setting the GPIB Parameters from the Front Panel	1-6
Using TekVISA	1-8

Syntax and Commands

Command Syntax	2-1
Backus-Naur Form Definition	2-1
SCPI Commands and Queries	2-2
IEEE 488.2 Common Commands	2-10
Constructed Mnemonics	2-11
Command Groups	2-13
Functional Groups	2-14
IEEE Common Commands	2-15
:ABORt Commands	2-15
:CALCulate Commands	2-16
:CALibration Commands	2-17
:CONFigure Commands	2-17
:DISPlay Commands	2-18
:FETCh Commands	2-22
:FORMat Commands	2-23
:HCOPy Commands	2-23
:INITiate Commands	2-24
:INPut Commands	2-24
:INSTrument Commands	2-24
:MMEMory Commands	2-25
:PROGram Commands	2-25
:READ Commands	2-26
:SENSe Commands	2-27
:STATus Commands	2-31
:SYSTem Commands	2-31
:TRACe Commands	2-32
:TRIGger Commands	2-32
:UNIT Commands	2-32
General Programming Procedure	2-33

IEEE Common Commands	2-35
:ABORt Commands	2-45
:CALCulate Commands	2-47
:CALibration Commands	2-63
:CONFigure Commands	2-71
:DISPlay Commands	2-83
:FETCh Commands	2-175
:FORMat Commands	2-207
:HCOPy Commands	2-209
:INITiate Commands	2-213
:INPut Commands	2-217
:INSTrument Commands	2-223
:MMEMory Commands	2-227
:PROGram Commands	2-235
:READ Commands	2-241
:SENSe Commands	2-273
:STATus Commands	2-369
:SYSTem Commands	2-377
:TRACe Commands	2-385
:TRIGger Commands	2-389
:UNIT Commands	2-399
Retrieving Response Message	2-401

Status and Events

Status and Event Reporting System	3-1
Registers	3-5
Status Registers	3-5
Enable Registers	3-9
Transition Registers	3-11
Queues	3-12
Status and Event Processing Sequence	3-13
Synchronizing Execution	3-14
Error Messages and Codes	3-17
Command Errors	3-18
Execution Errors	3-20
Device Specific Errors	3-22
Query Errors	3-22

Programming Examples

Application Program Sample	4-2
Macro Program Execution Sample	4-14

Appendices

Appendix A: Character Charts	A-1
Appendix B: GPIB Interface Specification	B-1
Interface Functions	B-1
Interface Messages	B-3
Appendix C: Factory Initialization Settings	C-1
Appendix D: Setting Range	D-1
Display Format and Scale	D-1
RBW	D-2
Appendix E: SCPI Conformance Information	E-1

Glossary and Index

List of Figures

Figure 1–1: Command parts	1–2
Figure 1–2: Functional groupings and an alphabetical list of commands	1–2
Figure 1–3: Event-driven program	1–3
Figure 1–4: Sample program (Visual C++ source code)	1–3
Figure 1–5: GPIB connector (rear panel)	1–4
Figure 1–6: GPIB connection	1–5
Figure 1–7: Typical GPIB network configurations	1–5
Figure 1–8: Remote Setup menu	1–6
Figure 1–9: Setting the GPIB parameters	1–7
Figure 2–1: Example of SCPI subsystem hierarchy tree	2–2
Figure 2–2: Example of abbreviating a command	2–6
Figure 2–3: Example of chaining commands and queries	2–7
Figure 2–4: Example of omitting root and lower-level nodes in a chained message	2–7
Figure 2–5: View number assignments	2–47
Figure 2–6: Horizontal scale setting requirements	2–84
Figure 2–7: Horizontal scale setting requirements for spectrum view	2–85
Figure 2–8: :DISPlay:CCDF command setting	2–86
Figure 2–9: :DISPlay:DDEMod command setting	2–94
Figure 2–10: :DISPlay:OView command setting	2–122
Figure 2–11: :DISPlay:PULSe:SPECtrum command setting	2–141
Figure 2–12: :DISPlay:SPECtrum command setting	2–150
Figure 2–13: :DISPlay:TFRrequency command setting	2–160
Figure 2–14: View display formats	2–170
Figure 2–15: :DISPlay:WAVEform command setting	2–171
Figure 2–16: Setting up the ACPR measurement	2–276
Figure 2–17: Defining the analysis range	2–278
Figure 2–18: Setting up the channel power measurement	2–293
Figure 2–19: Setting up the C/N measurement	2–296
Figure 2–20: Defining the analysis range	2–306
Figure 2–21: Setting up the EBW measurement	2–325
Figure 2–22: Setting frequency and span	2–327
Figure 2–23: Setting up the OBW measurement	2–337

Figure 2–24: Setting up the spurious signal measurement	2–361
Figure 2–25: Defining the analysis range	2–364
Figure 2–26: Trigger mask setting example	2–391
Figure 2–27: Retrieving response message	2–401
Figure 3–1: Status/Event reporting mechanism	3–2
Figure 3–2: The Status Byte Register (SBR)	3–6
Figure 3–3: The Standard Event Status Register (SESR)	3–7
Figure 3–4: The Operation Condition Register (OCR)	3–8
Figure 3–5: The Event Status Enable Register (ESER)	3–9
Figure 3–6: The Service Request Enable Register (SRER)	3–10
Figure 3–7: Operation Enable Register (OENR)	3–10
Figure 3–8: Operation Transition Register (OTR)	3–11
Figure 3–9: Status and event processing sequence	3–13
Figure 4–1: Saving the macro programs	4–14

List of Tables

Table 2–1: BNF symbols and meanings	2–1
Table 2–2: Query response examples	2–3
Table 2–3: Parameter types used in syntax descriptions	2–4
Table 2–4: Available units	2–8
Table 2–5: Available SI prefixes	2–8
Table 2–6: Constructed mnemonics	2–11
Table 2–7: Measurement mode	2–13
Table 2–8: List of command groups	2–14
Table 2–9: IEEE common commands	2–15
Table 2–10: :ABORt commands	2–15
Table 2–11: :CALCulate commands	2–16
Table 2–12: :CALibration commands	2–17
Table 2–13: :CONFigure commands	2–17
Table 2–14: :DISPlay commands	2–18
Table 2–15: :FETCh commands	2–22
Table 2–16: :FORMat commands	2–23
Table 2–17: :HCOPy commands	2–23
Table 2–18: :INITiate commands	2–24
Table 2–19: :INPut commands	2–24
Table 2–20: :INSTRument commands	2–24
Table 2–21: :MMEMory commands	2–25
Table 2–22: :PROGram commands	2–25
Table 2–23: :READ commands	2–26
Table 2–24: :SENSE commands	2–27
Table 2–25: :STATus commands	2–31
Table 2–26: :SYSTem commands	2–31
Table 2–27: :TRACe commands	2–32
Table 2–28: :TRIGger commands	2–32
Table 2–29: :UNIT commands	2–32
Table 2–30: :DISPlay command subgroups	2–83
Table 2–31: Main view display formats	2–97
Table 2–32: Subview display formats	2–111
Table 2–33: Subview display format	2–137
Table 2–34: Queried information on the digital modulation analysis results	2–183

Table 2–35: Queried information	2–190
Table 2–36: Input attenuation settings	2–218
Table 2–37: Mixer level settings	2–221
Table 2–38: Reference level range	2–222
Table 2–39: Measurement mode	2–224
Table 2–40: Queried information on the digital modulation analysis results	2–249
Table 2–41: :SENSe command subgroups	2–273
Table 2–42: Measurement item selections	2–282
Table 2–43: Block size setting range	2–287
Table 2–44: Modulation selections	2–313
Table 2–45: Communication standard selections	2–322
Table 2–46: Measurement frequency bands	2–328
Table 2–47: Span setting	2–334
Table 2–48: FFT windows	2–357
Table 2–49: S/A mode measurement items	2–359
Table 2–50: Bin number setting range	2–390
Table 3–1: SBR bit functions	3–6
Table 3–2: SESR bit functions	3–7
Table 3–3: OCR bit functions	3–8
Table 3–4: Command errors	3–18
Table 3–5: Execution errors	3–20
Table 3–6: Device specific errors	3–22
Table 3–7: Query errors	3–22
Table A–1: ASCII & GPIB code chart	A–2
Table B–1: GPIB interface function implementation	B–1
Table B–2: Standard interface messages	B–3
Table C–1: Factory initialization settings — IEEE common commands	C–1
Table C–2: Factory initialization settings — :CALCulate commands	C–1
Table C–3: Factory initialization settings — :CALibration commands	C–1
Table C–4: Factory initialization settings — :DISPlay commands	C–2
Table C–5: Factory initialization settings — :FORMat commands	C–5
Table C–6: Factory initialization settings — :INITiate commands	C–5

Table C-7: Factory initialization settings — :INPut commands	C-5
Table C-8: Factory initialization settings — :SENSE commands	C-6
Table C-9: Factory initialization settings — :STATus commands	C-9
Table C-10: Factory initialization settings — :TRACe commands	C-9
Table C-11: Factory initialization settings — :TRIGger commands	C-10
Table C-12: Factory initialization settings — :UNIT commands	C-10
Table D-1: Display format and scale	D-1
Table D-2: RBW setting range	D-2
Table E-1: SCPI conformance information — IEEE common commands	E-1
Table E-2: SCPI conformance information — :ABORt commands	E-1
Table E-3: SCPI conformance information — :CALCulate commands	E-2
Table E-4: SCPI conformance information — :CALibration commands	E-2
Table E-5: SCPI conformance information — :CONFigure commands	E-3
Table E-6: SCPI conformance information — :DISPlay commands	E-3
Table E-7: SCPI conformance information — :FETCh commands	E-7
Table E-8: SCPI conformance information — :HCOPy commands	E-8
Table E-9: SCPI conformance information — :INITiate commands	E-8
Table E-10: SCPI conformance information — :INPut commands	E-9
Table E-11: SCPI conformance information — :INSTrument commands	E-9
Table E-12: SCPI conformance information — :MMEMory commands	E-9
Table E-13: SCPI conformance information — :PROGram commands	E-10
Table E-14: SCPI conformance information — :READ commands	E-10
Table E-15: SCPI conformance information — :SENSE commands	E-11
Table E-16: SCPI conformance information — :STATus commands	E-15
Table E-17: SCPI conformance information — :SYSTem commands	E-15
Table E-18: SCPI conformance information — :TRACe commands	E-16
Table E-19: SCPI conformance information — :TRIGger commands	E-16
Table E-20: SCPI conformance information — :UNIT commands	E-16

Preface

This programmer manual is for the RSA3303A and RSA3308A Real-Time Spectrum Analyzers. It provides information on operating your analyzer using the General Purpose Interface Bus (GPIB).

This manual is composed of the following sections:

- *Getting Started* outlines how to use the GPIB interface.
- *Syntax and Commands* defines the syntax used in command descriptions, presents a list of all command subsystems, and presents detailed descriptions of all programming commands.
- *Status and Events* describes how the status and Events Reporting system operates and presents a list of all system errors.
- *Programming Examples* describes some example analyzer programs.
- *Appendices* provides additional information including character charts, GPIB interface specification, and factory initialization settings.

Related Manual

RSA3303A and RSA3308A User Manual

(Standard accessory; Tektronix part number 071-1409-XX)

Describes how to install the analyzer and how to work with the menus and details the functions.

Difference between RSA3303A and RSA3308A

RSA3303A and RSA3308A have the same functions except for their measurement frequency ranges:

RSA3303A DC to 3 GHz
RSA3308A DC to 8 GHz

Unless otherwise noted, descriptions in this manual apply to both.

Getting Started

Getting Started

You can write computer programs that remotely set the analyzer front panel controls or that take measurements and read those measurements for further analysis or storage.

To help you get started with programming the analyzer, this section includes the following sections:

- *Overview of the Manual*
Summarizes the type of programming information contained in each major section of this manual.
- *Connecting the Interface*
Describes how to physically connect the analyzer to a controller.
- *Using GPIB Ports*
Describes how to use the GPIB port.
- *Setting the GPIB Parameters from the Front Panel*
Describes how to set the GPIB parameters from the front panel.
- *Using TekVISA*
Describes how to use the TekVISA communication protocol.

Overview of the Manual

The information contained in each major section of this manual is described below.

Syntax and Commands

Section 2, *Syntax and Commands*, describes the structure and content of the messages your program sends to the analyzer. Figure 1–1 shows command parts as described in the *Command Syntax* subsection.

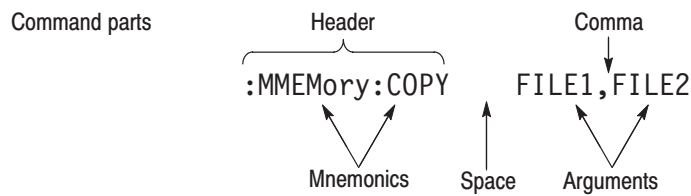

Figure 1–1: Command parts

Section 2 also describes the effect of each command and provides examples of how you might use it. The *Command Groups* section provides lists by functional areas. The *IEEE Common Commands* and the subsequent sections arrange commands alphabetically (Figure 1–2).

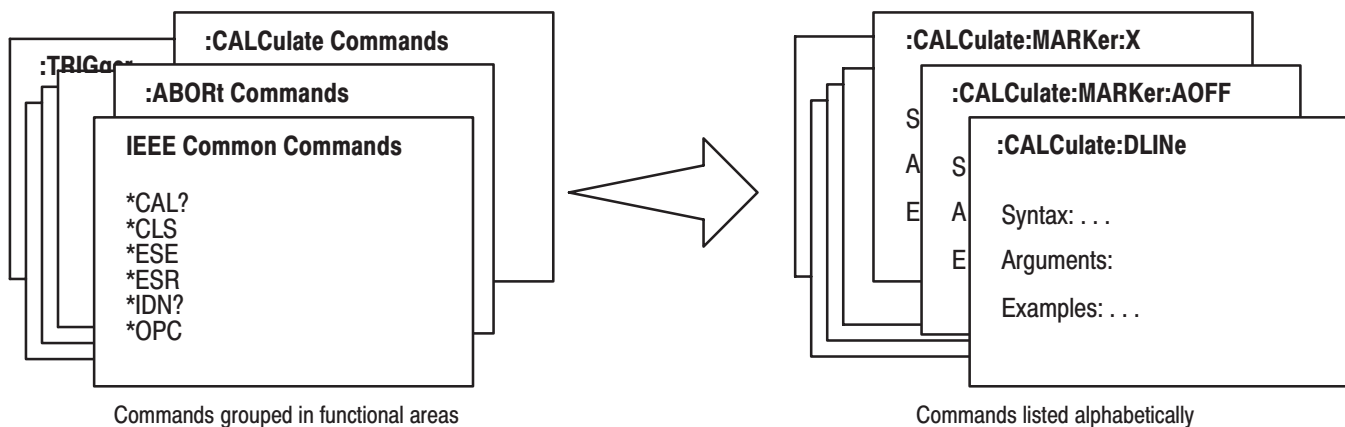

Figure 1–2: Functional groupings and an alphabetical list of commands

Status and Events

The program may request information from the analyzer. The analyzer provides information in the form of status and error messages. Figure 1–3 illustrates the basic operation of this system.

Section 3, *Status and Events*, describes how to get status or event information from the program and details the event and error messages.

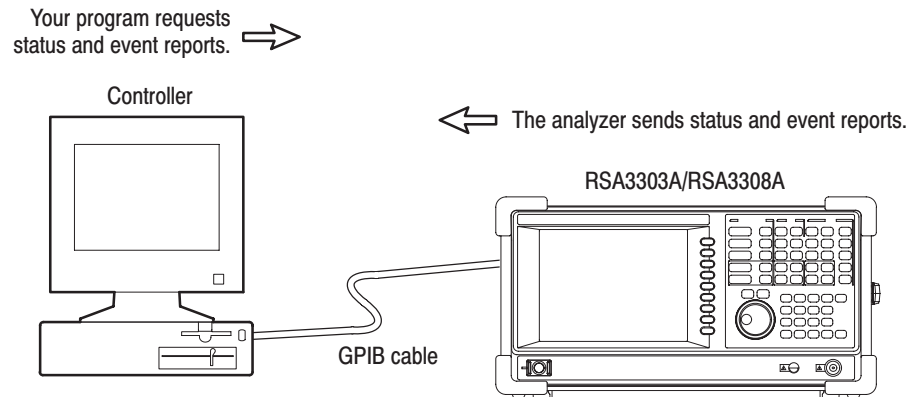

Figure 1–3: Event-driven program

Programming Examples

Section 4, *Programming Examples*, includes Visual C++ source code as well as sample programs for running macro programs.

```

)
GpibWrite("INSTRument 'SANORMAL'");
GpibWrite("*RST");
GpibTimeout(NORMAL_TIME);
GpibWrite("CONFigure:SPECTrum:CHPower");
GpibWrite("FREQuency:BAND RF1B");
GpibWrite("FREQuency:CENTer 1GHz");
GpibWrite("FREQuency:SPAN 1MHz");
GpibWrite("*CAL?");
GpibRead(readBuf, MAX_BUF);
printf("*CAL? result = %s\n", readBuf);
GpibWrite("CHPower:BANDwidth:INTEgration 300kHz");
GpibWrite("SPECTrum:AVERAge ON");
)

```

Figure 1–4: Sample program (Visual C++ source code)

Connecting the Interface

The analyzer has a 24-pin GPIB connector on its rear panel, as shown in Figure 1-5. This connector has a D-type shell and conforms to IEEE Std 488.1-1987.

Attach an IEEE Std 488.1-1987 GPIB cable (Tektronix part number 012-0991-00) to this connector.

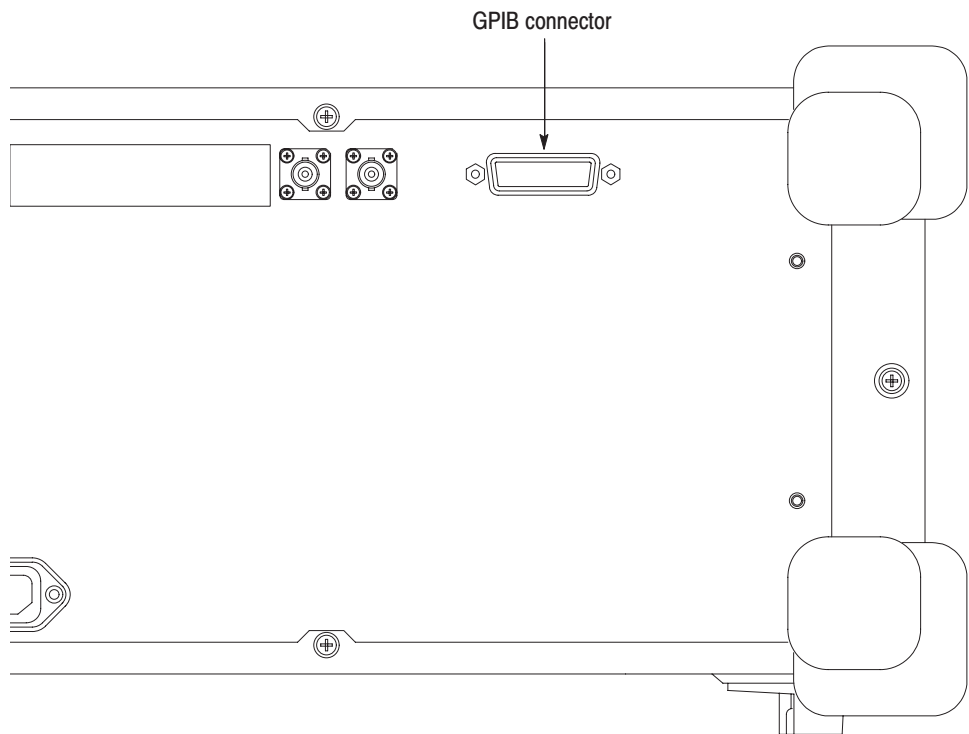

Figure 1-5: GPIB connector (rear panel)

Appendix B: GPIB Interface Specifications gives more information on the GPIB configuration of the analyzer.

For the other interfaces, refer to the *RSA3303A and RSA3308A User Manual*.

Using the GPIB Port

The analyzer has Talker/Listener functions through which it can communicate with other devices, as well as the external controller, located on the bus.

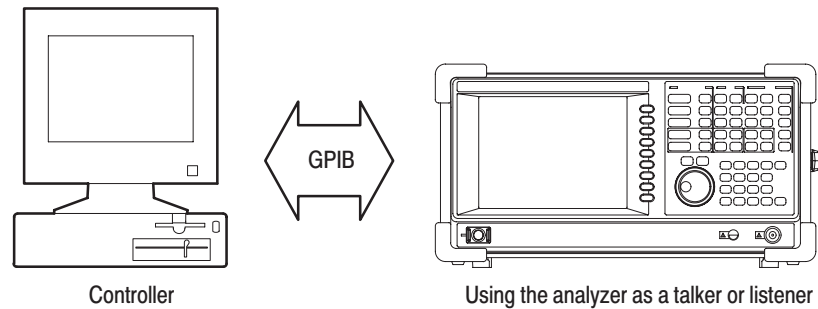

Figure 1-6: GPIB connection

GPIB Requirements

Observe these rules when you use your analyzer with a GPIB network:

- Assign a unique device address to each device on the bus. No two devices can share the same device address.
- Do not connect more than 15 devices to any one bus.
- Connect one device for every 2 meters (6 feet) of cable used.
- Do not use more than 20 meters (65 feet) of cable to connect devices to a bus.
- Turn on at least two-thirds of the devices on the network while using the network.
- Connect the devices on the network in a star or linear configuration as shown in Figure 1-7. Do not use loop or parallel configurations.

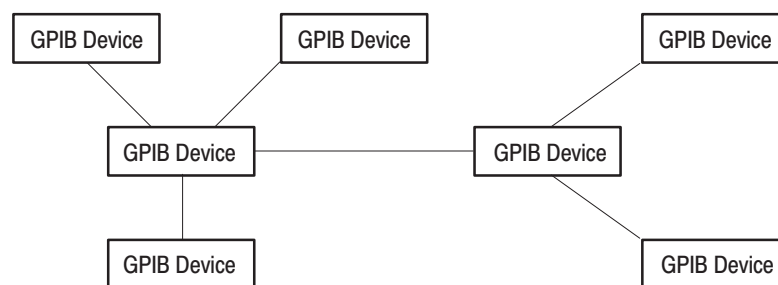

Figure 1-7: Typical GPIB network configurations

Setting the GPIB Parameters from the Front Panel

Use the **SYSTEM** → **Remote Setup** menu to set the GPIB parameters as required for the bus configuration. Once you have set the parameters, you can control the analyzer through the GPIB interface.

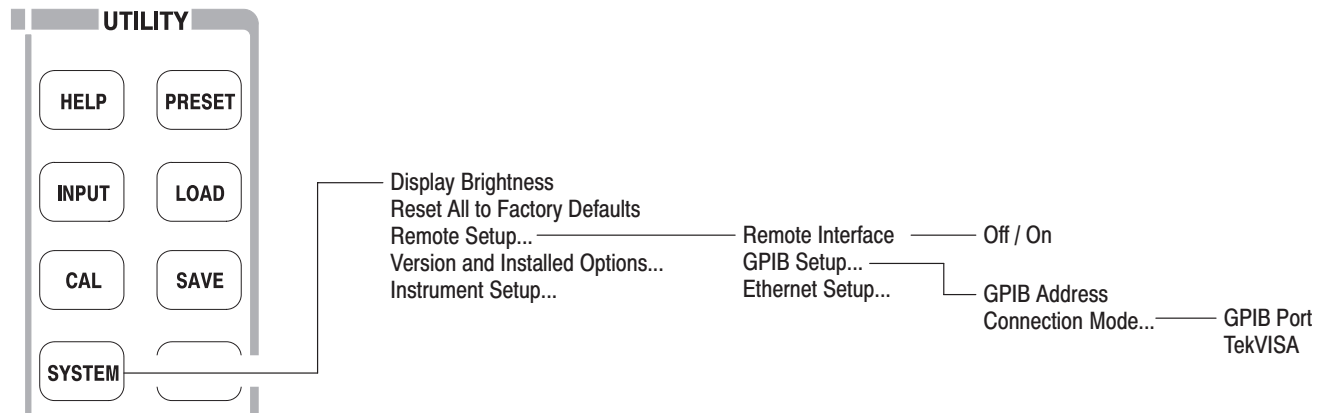

Figure 1–8: Remote Setup menu

Remote Setup Menu

The Remote Setup menu contains the following controls:

Remote Interface. Turns on or off the connection between the analyzer and the interface bus.

GPIB Setup... Sets the GPIB address and connection mode.

GPIB Address. Sets the GPIB address of the analyzer when GPIB Port is selected as the Connection Mode. Range: 0 to 30 (default: 1)

Connection Mode. Selects the physical GPIB port or the virtual (TekVISA) connection method.

- **GPIB Port.** *Default.* Uses the IEEE488.2 connector on the rear panel of the analyzer to communicate with an external controller. Refer to the next section *Setting up the GPIB port* for the procedure.
- **TekVISA.** Uses TekVISA to communicate with test instrumentation through Ethernet (LAN connector on the side panel of the analyzer), and also to run a control program locally on the analyzer. Refer to *Using TekVISA* on page 1–8 for more information.

Ethernet Setup... Not available currently. Use the Windows XP Control Panel to set up networking parameters.

Setting Up the GPIB Port

When you use the GPIB port, follow these steps to set the parameters:

1. Press the **SYSTEM** key in the UTILITY block on the front panel.
2. Press the side key **Remote Setup...→ GPIB Setup...**

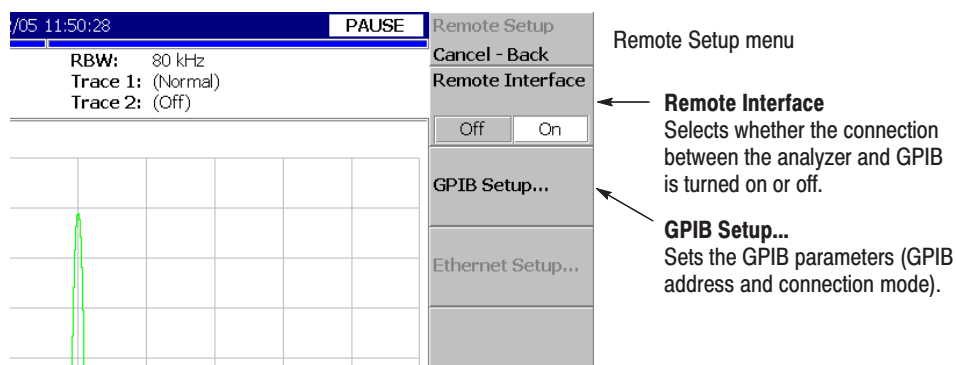

Figure 1-9: Setting the GPIB parameters

3. Press the **Connection Mode...** side key and select **GPIB Port**.
4. Press the **GPIB Address** side key and set the address using either the general purpose knob or the numeric keypad.

NOTE. The GPIB address cannot be initialized with *RST command.

5. Press the **Cancel-Back** (top) side key and then the **Remote Interface** side key to select **On**.

To disconnect the analyzer from the bus:

- Press the **Remote Interface** side key to select **Off**.

When the analyzer is disconnected from the bus, all the communication processes with the controller are interrupted.

Using TekVISA

TekVISA is Tektronix implementation of VISA (Virtual Instrument Software Architecture), an industry-standard communication protocol. It allows you to write programs using the WCA200A Series SCPI command set to control the instrument through interfaces besides the built-in IEEE 488.2 port. Programs are written to execute on the local or remote controller. The WCA200A Series implementation of TekVISA includes a subset of the TekVISA functionality offered on Tektronix oscilloscopes. The Virtual GPIB (GPIB8), GPIB, and LAN (VXI-11 protocol) interfaces are supported, but not the ASRL interface.

NOTE. *The details on TekVISA concepts and operations are explained in the TekVISA Programmer Manual. Refer to Installing TekVISA described below for accessing the files.*

Be aware of the following points:

- If TekVISA is not installed or has not been activated, and you select TekVISA as the connection mode, the instrument still attempts to connect to TekVISA. This does not hang up the instrument, but the GPIB port is taken off-line until you select GPIB Port as the connection mode again.
- Applications which are designed to execute locally on the instrument need to share the Windows processor with the measurement calculation software of the analyzer. If the controller application is very compute-intensive, it will slow down the analyzer application significantly.

Installing TekVISA

The TekVISA tools are not installed when you receive the instrument. Use the following procedure to install the tools.

To use TekVISA, these conditions must be satisfied:

- Windows XP is used as the instrument's operating system. Instruments using Windows 98SE must be upgraded to Windows XP for TekVISA to operate properly.
- A TekVISA-compatible version of the analyzer application is installed and running on the instrument. Version must be greater than 3.00.000.
- TekVISA is installed on the instrument. Version 2.03 is recommended.

The TekVISA-related files are on the internal hard disk of the analyzer in these directories:

- *C:\Tektronix\TekVISA\installer* contains the TekVISA installer.
- *C:\Tektronix\TekVISA>manual* contains the TekVISA Programmer Manual.

Use the following steps to install the TekVISA tools on your analyzer:

NOTE. For details on accessing Windows XP on the analyzer, refer to the RSA3303A and RSA3308A User Manual.

1. Connect a USB mouse and keyboard to the USB ports on the side panel of the analyzer.
2. Display the Windows XP desktop on the screen.
3. Find the *setup.exe* file in the *C:\Tektronix\TekVISA\installer* directory using Windows Explorer or other file access methods.
4. Run *setup.exe* and follow the instructions.

The *TekVISA Programmer Manual* is found in the *C:\Tektronix\TekVISA>manual* directory.

Syntax and Commands

Command Syntax

This section contains information on the Standard Commands for Programmable Instruments (SCPI) and IEEE 488.2 Common Commands you can use to program your RSA3303A/RSA3308A analyzer. The information is organized in the following subsections:

- Backus-Naur Form Definition
- SCPI Commands and Queries
- IEEE 488.2 Common Commands
- Constructed Mnemonics

Backus-Naur Form Definition

This manual may describe commands and queries using the Backus-Naur Form (BNF) notation. Table 2-1 defines the standard BNF symbols:

Table 2-1: BNF symbols and meanings

Symbol	Meaning
< >	Defined element
::=	Is defined as
	Exclusive OR
{ }	Group; one element is required
[]	Optional; can be omitted
. . .	Previous element(s) may be repeated
()	Comment

SCPI Commands and Queries

SCPI is a standard created by a consortium that provides guidelines for remote programming of instruments. These guidelines provide a consistent programming environment for instrument control and data transfer. This environment uses defined programming messages, instrument responses, and data format across all SCPI instruments, regardless of manufacturer. The analyzer uses a command language based on the SCPI standard.

The SCPI language is based on a hierarchical or tree structure (see Figure 2–1) that represents a subsystem. The top level of the tree is the root node; it is followed by one or more lower-level nodes.

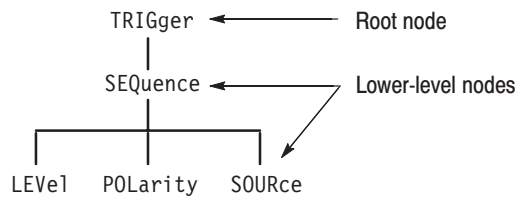

Figure 2-1: Example of SCPI subsystem hierarchy tree

You can create commands and queries from these subsystem hierarchy trees. Commands specify actions for the instrument to perform. Queries return measurement data and information about parameter settings.

Creating Commands

SCPI commands are created by stringing together the nodes of a subsystem hierarchy and separating each node by a colon.

In Figure 2–1, TRIGger is the root node and SEQuence, LEVel, POLarity, and SOURce are lower-level nodes. To create a SCPI command, start with the root node TRIGger and move down the tree structure adding nodes until you reach the end of a branch. Most commands and some queries have parameters; you must include a value for these parameters. If you specify a parameter value that is out of range, the parameter will be set to a default value. The command descriptions, which start on page 2–35, list the valid values for all parameters.

For example, TRIGger:SEQuence:SOURce EXT is a valid SCPI command created from the hierarchy tree in Figure 2–1.

Creating Queries

To create a query, start at the root node of a tree structure, move down to the end of a branch, and add a question mark. TRIGger:SEQuence:SOURce? is an example of a valid SCPI query using the hierarchy tree in Figure 2–1.

Query Responses

The query causes the analyzer to return information about its status or settings. When a query is sent to the analyzer, only the values are returned. When the returned value is a mnemonic, it is noted in abbreviated format, as shown in Table 2–2.

Table 2-2: Query response examples

Query	Response
:DISPlay:OVlew:SGRam:X:SPAN?	10.0E+6
:SENSe:AVERage:TYPE?	RMS

A few queries also initiate an operation action before returning information. For example, the *CAL? query runs a calibration.

Parameter Types

Every parameter in the command and query descriptions is of a specified type. The parameters are enclosed in brackets, such as <value>. The parameter type is listed after the parameter and is enclosed in parentheses, for example, (discrete). Some parameter types are defined specifically for the RSA3300 Series command set and some are defined by ANSI/IEEE 488.2-1987 (refer to Table 2–3).

Table 2–3: Parameter types used in syntax descriptions

Parameter type	Description	Example
arbitrary block ¹	A specified length of arbitrary data	#512234xxxx . . . where 5 indicates that the following 5 digits (12234) specify the length of the data in bytes; xxxxx ... indicates the data
boolean	Boolean numbers or values	ON or 1; OFF or 0
discrete	A list of specific values	MIN, MAX, UP, DOWN
binary	Binary numbers	#B0110
octal	Octal numbers	#Q57, #Q3
hexadecimal ²	Hexadecimal numbers (0–9, A, B, C, D, E, F)	#HAA, #H1
NR1 ^{2,3} numeric	Integers	0, 1, 15, -1
NR2 ² numeric	Decimal numbers	1.2, 3.141516, -6.5
NR3 ² numeric	Floating point numbers	3.1415E-9, -16.1E5
NRf ² numeric	Flexible decimal number that may be type NR1, NR2 or NR3	See NR1, NR2, and NR3 examples
string ⁴	Alphanumeric characters (must be within quotation marks)	“Testing 1, 2, 3”

¹ Defined in ANSI/IEEE 488.2 as “Definite Length Arbitrary Block Response Data.”

² An ANSI/IEEE 488.2–1992-defined parameter type.

³ Some commands and queries will accept an octal or hexadecimal value even though the parameter type is defined as NR1.

⁴ Defined in ANSI/IEEE 488.2 as “String Response Data.”

SCPI-defined Parameters. In addition to the ANSI/IEEE 488.2-1987-defined parameters, RSA3300 Series support the following SCPI-defined parameters.

- <NRf> for boolean

OFF | ON | 0 | 1 | <NRf>

You can use <NRf> for boolean parameter. The values other than zero (OFF) are regarded as one (ON).

- MAXimum and MINimum for numeric parameters

You can use MAXimum and MINimum for the numeric parameter <NRf>. The following example sets the trigger level to the maximum (100%).

```
:TRIGger[:SEquence]:LEVel:IF MAXimum
```

The commands that have numeric parameters support the following query:

```
<header>? { MAXimum | MINimum }
```

The query command returns the maximum or minimum acceptable value for the command. For example,

```
:TRIGger[:SEquence]:LEVel:IF? MAXimum
```

returns 100 indicating the maximum trigger level is 100%.

- UP and DOWN for numeric parameters

The [:SENse]:FREQuency:CENTer command (refer to page 2–329) supports UP and DOWN for the numeric parameters. The increment/decrement of UP/DOWN is determined by one of these commands:

```
[[:SENse]:FREQuency:CENTer:STEP:AUTO  
[:SENse]:FREQuency:CENTer:STEP[:INCRement]
```

Special Characters

The Line Feed (LF) character (ASCII 10), and all characters in the range of ASCII 127-255 are defined as special characters. These characters are used in arbitrary block arguments only; using these characters in other parts of any command yields unpredictable results.

Abbreviating Commands, Queries, and Parameters

You can abbreviate most SCPI commands, queries, and parameters to an accepted short form. This manual shows these short forms as a combination of upper and lower case letters. The upper case letters indicate the accepted short form of a command. As shown in Figure 2–2, you can create a short form by using only the upper case letters. The accepted short form and the long form are equivalent and request the same action of the instrument.

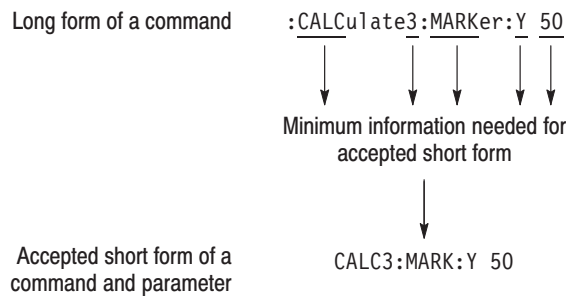

Figure 2-2: Example of abbreviating a command

NOTE. The numeric suffix of a command or query may be included in either the long form or short form; the analyzer will default to “1” if no suffix is used. In Figure 2–2, the “3” of “CALC3” indicates that the command is directed to View 3.

Chaining Commands and Queries

You can chain several commands or queries together into a single message. To create a chained message, first create a command or query, add a semicolon (;), and then add more commands or queries and semicolons until the message is complete. If the command following a semicolon is a root node, precede it with a colon (:). Figure 2–3 illustrates a chained message consisting of several commands and queries. The single chained message should end in a command or query, not a semicolon. Responses to any queries in your message are separated by semicolons.

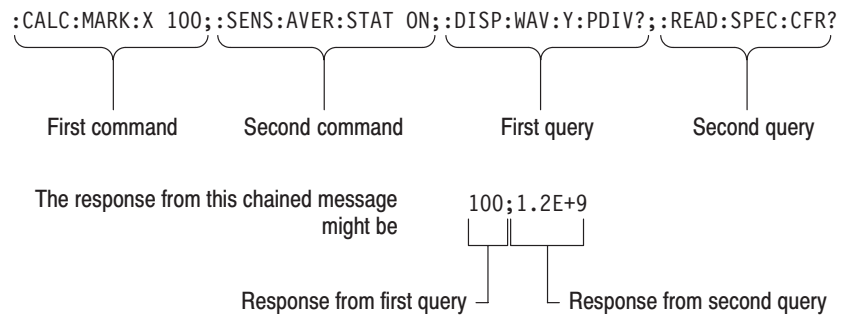

Figure 2–3: Example of chaining commands and queries

If a command or query has the same root and lower-level nodes as the previous command or query, you can omit these nodes. In Figure 2–4, the second command has the same root node (TRIG:SEquence) as the first command, so these nodes can be omitted.

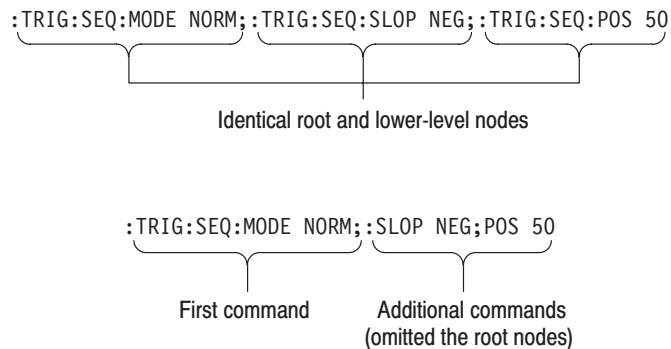

Figure 2–4: Example of omitting root and lower-level nodes in a chained message

Unit and SI Prefix

If the decimal numeric argument refers to amplitude, frequency, or time, you can express it using SI units instead of using the scaled explicit point input value format <NR3>. (SI units are units that conform to the Systeme International d’Unites standard.) For example, you can use the input format 200 mV or 1.0 MHz instead of 200.0E-3 or 1.0E+6, respectively, to specify voltage or frequency.

Table 2-4 lists the available units:

Table 2-4: Available units

Symbol	Meaning
dB	decibel (relative amplitude)
dBm	decibel (absolute amplitude)
DEG	degree (phase)
Hz	hertz (frequency)
PCT	percent (%)
s	second (time)
V	volt

The available SI prefixes are shown in Table 2-5 below:

Table 2-5: Available SI prefixes

SI prefix	A	F	P	N	U	M	K	MA ¹	G	T	PE	EX
Corresponding power	10 ⁻¹⁸	10 ⁻¹⁵	10 ⁻¹²	10 ⁻⁹	10 ⁻⁶	10 ⁻³	10 ⁺³	10 ⁺⁶	10 ⁺⁹	10 ⁺¹²	10 ⁺¹⁵	10 ⁺¹⁸

¹ When the unit is “Hz”, “M” may be used instead of “MA” so that the frequency can be represented by “MHz”.

You can omit a unit in a command, but you must include the unit when using a SI prefix. For example, frequency of 15 MHz can be described as follows:

15.0E6, 1.5E7Hz, 15000000, 15000000Hz, 15MHz, etc.
 (“15M” is not allowed.)

Note that you can use either lower or upper case units and prefixes. The following examples have the same result, respectively.

170mhz, 170mHz, 170MHz, etc.
 250mv, 250mV, 250MV, etc.

General Rules

Here are three general rules for using SCPI commands, queries, and parameters:

- You can use single (‘ ’) or double (“ ”) quotation marks for quoted strings, but you cannot use both types of quotation marks for the same string.

correct: “This string uses quotation marks correctly.”

correct: ‘This string also uses quotation marks correctly.’

incorrect: “This string does not use quotation marks correctly.’

- You can use upper case, lower case, or a mixture of both cases for all commands, queries, and parameters.

SENSE:SPECTRUM:FFT:LENGTH 1024

is the same as

sense:spectrum:fft:length 1024

and

SENSE:spectrum:FFT:length 1024

NOTE. *Literal strings (quoted) are case sensitive. For example: file names.*

- No embedded spaces are allowed between or within nodes.

correct: SENSE:SPECTRUM:FFT:LENGTH 1024

incorrect: SENSE: SPECTRUM: FFT: LEN GTH 1024

IEEE 488.2 Common Commands

Description ANSI/IEEE Standard 488.2 defines the codes, formats, protocols, and usage of common commands and queries used on the interface between the controller and the instruments. The analyzer complies with this standard.

Command and Query Structure The syntax for an IEEE 488.2 common command is an asterisk (*) followed by a command and, optionally, a space and parameter value. The syntax for an IEEE 488.2 common query is an asterisk (*) followed by a query and a question mark. All of the common commands and queries are listed in the last part of the *Syntax and Commands* section. The following are examples of common commands:

- *ESE 16
- *CLS

The following are examples of common queries:

- *ESR?
- *IDN?

Constructed Mnemonics

Some header mnemonics specify one of a range of mnemonics. For example, a channel mnemonic can be either CALCulate1, CALCulate2, CALCulate3, or CALCulate4. You use these mnemonics in the command just as you do any other mnemonic. For example, there is a :CALCulate1:MARKer:MODE command, and there is also a :CALCulate2:MARKer:MODE command. In the command descriptions, this list of choices is abbreviated as CALCulate<x>. The value of <x> is the upper range of valid suffixes. If the numeric suffix is omitted, the analyzer uses the default value of “1”.

Table 2-6: Constructed mnemonics

Symbol	Meaning
CALCulate<x>	A view specifier where <x> = 1 to 4.
DLINe<x>	A horizontal display line specifier where <x> = 1 or 2.
VLINe<x>	A vertical display line specifier where <x> = 1 or 2.
MARKer<x>	A marker specifier where <x> = 1 or 2.
TRACe<x> DATA<x>	A trace specifier where <x> = 1 or 2.

Command Groups

This section lists the RSA3300 Series analyzer commands in two ways. It first presents them by functional groups. It then lists them alphabetically. The functional group list starts below. The alphabetical list provides more detail on each command and starts on page 2–35.

The RSA3300 Series analyzers conform to the Standard Commands for Programmable Instruments (SCPI) 1999.0 and IEEE Std 488.2-1987 except where noted.

Items followed by question marks are queries; items without question marks are commands. Some items in this section have a question mark in parentheses (?) in the command header section; this indicates that the item can be both a command and a query.

Each command may be available or unavailable, depending on the current measurement mode. The “Measurement Modes” item in each command description shows the measurement mode in which the command is available. To set the measurement mode, use the :INSTrument[:SElect] command (refer to page 2–225) using one of the mnemonics listed below:

Table 2-7: Measurement mode

Mnemonic	Meaning
SANORMAL	Normal spectrum analysis
SASGRAM	Spectrum analysis with spectrogram
SARTIME	Real-time spectrum analysis
DEMADEM	Analog modulation analysis
DEMDEM	Digital modulation analysis (Option 21 only)
TIMCCDF	CCDF analysis
TIMTRAN	Time characteristic analysis
TIMPULSE	Pulse characteristics analysis

For the conventions of notation in this manual, refer to *Command Syntax* on page 2-1 and following pages.

Functional Groups

The commands are divided into the groups listed below.

Table 2-8: List of command groups

Command group	Function
IEEE common	Conforms to the IEEE Std 488.2-1987.
:ABORt	Resets and restarts sweep, measurement, and trigger.
:CALCulate	Controls the markers and the display line.
:CALibration	Calibrates the analyzer.
:CONFigure	Configures the analyzer for each measurement session.
:DISPlay	Controls how to show waveform and measurement result on screen.
:FETCh	Retrieves the measurements from the data last acquired.
:FORMat	Sets the output data format.
:HCOPy	Controls screen hardcopy.
:INITiate	Controls data acquisition.
:INPut	Sets the input-related conditions.
:INSTrument	Selects a measurement mode.
:MMEMory	Controls file saving/loading to/from the hard disk or floppy disk.
:PROGram	Controls macro programs.
:READ	Obtains the measurement results with acquiring data.
:SENSe	Sets up detailed conditions for each measurement.
:STATus	Controls the status and event registers.
:SYSTem	Sets the system parameters and query system information.
:TRACe	Controls display of Trace 1 and 2.
:TRIGger	Controls triggering.
:UNIT	Specifies fundamental units for measurement.

The following sections list the commands by group.

IEEE Common Commands

The IEEE 488.2 common commands have a “*” prefix.

Table 2-9: IEEE common commands

Header	Description
*CAL?	Runs all the calibration routines.
*CLS	Clears the status or event.
*ESE(?)	Sets the value for the ESER register.
*ESR?	Queries the SESR register value.
*IDN?	Queries the analyzer ID.
*OPC(?)	Synchronizes commands.
*OPT?	Queries the options incorporated in the analyzer.
*RST	Restores the factory initialization settings.
*SRE(?)	Sets the value for the SRER register.
*STB?	Queries the Status Byte Register value.
*TRG	Generates a trigger event.
*TST?	Runs a self test.
*WAI	Waits until the run of another command is completed.

:ABORt Commands

Resets the trigger system and related actions such as data acquisition and measurement.

Table 2-10: :ABORt commands

Header	Description
:ABORt	Resets and restarts sweep, trigger, and measurement.

:CALCulate Commands

Control the marker and the display line.

Table 2-11: :CALCulate commands

Header	Description
:CALCulate<x>:DLINe<y>(?)	Sets the vertical position of the horizontal line.
:CALCulate<x>:DLINe<y>:STATe(?)	Determines whether to show the horizontal line.
:CALCulate<x>:MARKer:AOff	Turns off all the markers.
:CALCulate<x>:MARKer<y>:MAXimum	Places the marker at the maximum point on the trace.
:CALCulate<x>:MARKer<y>:MODE(?)	Selects the marker mode (position or delta).
:CALCulate<x>:MARKer<y>:PEAK:HIGHer	Moves the marker to the next higher peak.
:CALCulate<x>:MARKer<y>:PEAK:LEFt	Moves the marker to the peak on the left.
:CALCulate<x>:MARKer<y>:PEAK:LOWer	Moves the marker to the next lower peak.
:CALCulate<x>:MARKer<y>:PEAK:RIGHt	Moves the marker to the peak on the right.
:CALCulate<x>:MARKer<y>:PTHReshold(?)	Sets the minimum jump of the marker on the horizontal axis.
:CALCulate<x>:MARKer<y>:RCURsor	Displays the reference cursor at the marker position.
:CALCulate<x>:MARKer<y>:ROFF	Turn off the reference cursor.
:CALCulate<x>:MARKer<y>[:SET]:CENTer	Sets the center frequency to the value at the marker position.
:CALCulate<x>:MARKer<y>[:SET]:MEASurement	Sets the measurement position with the marker.
:CALCulate<x>:MARKer<y>[:STATe]	Determines whether to show the marker.
:CALCulate<x>:MARKer<y>:T(?)	Positions the marker on the time axis.
:CALCulate<x>:MARKer<y>:TOGgLe	Replaces the delta marker with the main marker.
:CALCulate<x>:MARKer<y>:TRACe(?)	Selects the trace to place the marker.
:CALCulate<x>:MARKer<y>:X(?)	Positions the marker on the horizontal axis.
:CALCulate<x>:MARKer<y>:Y(?)	Positions the marker on the vertical axis.
:CALCulate<x>:VLINe<y>(?)	Sets the horizontal position of the vertical line.
:CALCulate<x>:VLINe<y>:STATe(?)	Determines whether to show the vertical line.

:CALibration Commands

Calibrate the analyzer.

Table 2-12: :CALibration commands

Header	Description
:CALibration[:ALL](?)	Runs all the calibration routines.
:CALibration:AUTO(?)	Determines whether to run the RF gain calibration automatically.
:CALibration:DATA:DEfault	Restores the calibrated data to the factory defaults.
:CALibration:OFFSet:BASEbanddc(?)	Runs the baseband DC offset calibration.
:CALibration:OFFSet:CENTer(?)	Runs the center offset calibration.
:CALibration:OFFSet:IQINput(?) (Option 03 only)	Runs the IQ input offset calibration.
:CALibration:RF(?)	Runs the RF gain calibration.

:CONFigure Commands

Set up the analyzer in order to perform the specified measurement.

Table 2-13: :CONFigure commands

Header	Description
:CONFigure:ADEMod:AM	Sets up the analyzer to the AM signal analysis default settings.
:CONFigure:ADEMod:FM	Sets up the analyzer to the FM signal analysis default settings.
:CONFigure:ADEMod:PM	Sets up the analyzer to the PM signal analysis default settings.
:CONFigure:CCDF	Sets the up analyzer to the CCDF measurement default settings.
:CONFigure:DDEMod (Option 21 only)	Sets up the analyzer to the digital modulation analysis default settings.
:CONFigure:OVlew	Turns off measurement to obtain display data in the overview
:CONFigure:PULSe	Sets the analyzer to the pulse characteristics measurement default settings.
:CONFigure:SPEctrum	Sets up the analyzer to the spectrum measurement default settings.
:CONFigure:SPEctrum:ACPwer	Sets up the analyzer to the ACPR measurement default settings.
:CONFigure:SPEctrum:CFRequency	Sets up the analyzer to the carrier frequency measurement default settings.
:CONFigure:SPEctrum:CHPwer	Sets up the analyzer to the channel power measurement default settings.
:CONFigure:SPEctrum:CNRatio	Sets up the analyzer to the C/N measurement default settings.
:CONFigure:SPEctrum:EBWidth	Sets up the analyzer to the emission bandwidth measurement default settings.
:CONFigure:SPEctrum:OBWidth	Sets up the analyzer to the OBW measurement default settings.
:CONFigure:SPEctrum:SPURious	Sets up the analyzer to the spurious signal measurement default settings.

Table 2-13: :CONFigure commands (Cont.)

Header	Description
:CONFigure:TFRequency:RTIME	Sets up the analyzer to the real-time spectrum measurement default settings.
:CONFigure:TFRequency:SGRam	Sets up the analyzer to the spectrogram measurement default settings.
:CONFigure:TRANsient:FVTime	Sets up the analyzer to the frequency vs. time measurement default settings.
:CONFigure:TRANsient:IQVTime	Sets up the analyzer to the IQ level vs. time measurement default settings.
:CONFigure:TRANsient:PVTime	Sets up the analyzer to the power vs. time measurement default settings.

:DISPlay Commands

Control how to show measurement data on the screen.

Table 2-14: :DISPlay commands

Header	Description
:DISPlay:CCDF subgroup	CCDF measurement related.
:DISPlay:CCDF:LINE:GAUSSian[:STATE](?)	Determines whether to show the Gaussian line.
:DISPlay:CCDF:LINE:REFerence[:STATE](?)	Determines whether to show the reference line.
:DISPlay:CCDF:LINE:REFerence:STORE	Stores the current CCDF trace as the reference line.
:DISPlay:CCDF:X[:SCALE]:AUTO(?)	Determines whether to set the horizontal scale automatically.
:DISPlay:CCDF:X[:SCALE]:MAXimum(?)	Sets the maximum horizontal value (right end).
:DISPlay:CCDF:X[:SCALE]:OFFSet(?)	Sets the minimum horizontal value (left end).
:DISPlay:CCDF:Y[:SCALE]:FIT	Runs auto-scale.
:DISPlay:CCDF:Y[:SCALE]:FULL	Sets the vertical axis to the default full-scale.
:DISPlay:CCDF:Y[:SCALE]:MAXimum(?)	Sets the maximum vertical value (top end).
:DISPlay:CCDF:Y[:SCALE]:MINimum(?)	Sets the minimum vertical value (bottom end).
:DISPlay:DDEMod subgroup (Option 21 only)	Digital modulation analysis related.
:DISPlay:DDEMod:CCDF:LINE:GAUSSian[:STATE](?)	Determines whether to display the Gaussian line.
:DISPlay:DDEMod:MView:DStArT(?)	Selects the decoding start position for ASK, FSK, and GFSK signals.
:DISPlay:DDEMod:MView:FORMat(?)	Selects the main view display format.
:DISPlay:DDEMod:MView:HSSHift(?)	Selects the Q data half symbol shift for an OQPSK signal.
:DISPlay:DDEMod:MView:RADix(?)	Selects the base of symbols in the main view.
:DISPlay:DDEMod:MView:X[:SCALE]:OFFSet(?)	Sets the minimum horizontal value (left edge) in the main view.
:DISPlay:DDEMod:MView:X[:SCALE]:RANGe(?)	Sets the horizontal full-scale in the main view.
:DISPlay:DDEMod:MView:Y[:SCALE]:FIT	Runs auto-scale on the main view.
:DISPlay:DDEMod:MView:Y[:SCALE]:FULL	Sets the main view's vertical axis to the default full-scale value.

Table 2-14: :DISPlay commands (Cont.)

Header	Description
:DISPlay:DDEMod:MVlew:Y[:SCALE]:MAXimum(?)	Sets the maximum vertical value (top end) in the CCDF main view.
:DISPlay:DDEMod:MVlew:Y[:SCALE]:MINimum(?)	Sets the minimum vertical value (top end) in the CCDF main view.
:DISPlay:DDEMod:MVlew:Y[:SCALE]:OFFSet(?)	Sets the minimum vertical value (bottom) in the main view.
:DISPlay:DDEMod:MVlew:Y[:SCALE]:RANGe(?)	Sets the vertical full-scale in the main view.
:DISPlay:DDEMod:NLINearity:LINE:BFIT[:STATe](?)	Determines whether to display the best-fit line.
:DISPlay:DDEMod:NLINearity:LINE:REFerence[:STATe](?)	Determines whether to display the recovered reference line.
:DISPlay:DDEMod:NLINearity:MASK[:STATe](?)	Determines whether the linear signal region is visible.
:DISPlay:DDEMod:SVlew:DStArt(?)	Selects the decoding start position for ASK, FSK, and GFSK signals.
:DISPlay:DDEMod:SVlew:FORMat(?)	Selects the subview display format.
:DISPlay:DDEMod:SVlew:HSSHift(?)	Selects the Q data half symbol shift for an OQPSK signal.
:DISPlay:DDEMod:SVlew:RADix(?)	Selects the base of symbols in the subview.
:DISPlay:DDEMod:SVlew:X[:SCALE]:OFFSet(?)	Sets the minimum horizontal value (left edge) in the subview.
:DISPlay:DDEMod:SVlew:X[:SCALE]:RANGe(?)	Sets the horizontal full-scale in the subview.
:DISPlay:DDEMod:SVlew:Y[:SCALE]:FIT	Runs auto-scale on the subview.
:DISPlay:DDEMod:SVlew:Y[:SCALE]:FULL	Sets the vertical axis to the default full-scale value in the subview.
:DISPlay:DDEMod:SVlew:Y[:SCALE]:MAXimum(?)	Sets the maximum vertical value (top end) in the CCDF subview.
:DISPlay:DDEMod:SVlew:Y[:SCALE]:MINimum(?)	Sets the minimum vertical value (top end) in the CCDF subview.
:DISPlay:DDEMod:SVlew:Y[:SCALE]:OFFSet(?)	Sets the minimum vertical value (bottom) in the subview.
:DISPlay:DDEMod:SVlew:Y[:SCALE]:RANGe(?)	Sets the vertical full-scale in the subview.
:DISPlay:OVlew subgroup	DEMOM and TIME mode overview related.
:DISPlay:OVlew:FORMat(?)	Selects the overview display format.
:DISPlay:OVlew:OTINdicator(?)	Determines whether to show the trigger output indicator.
:DISPlay:OVlew:SGRam:COLor[:SCALE]:OFFSet(?)	Sets the minimum color-axis value (bottom end) of the spectrogram.
:DISPlay:OVlew:SGRam:COLor[:SCALE]:RANGe(?)	Sets the color-axis full-scale of the spectrogram.
:DISPlay:OVlew:SGRam:X[:SCALE]:OFFSet(?)	Sets the minimum horizontal value (left end) of the spectrogram.
:DISPlay:OVlew:SGRam:X[:SCALE]:SPAN(?)	Sets the horizontal full-scale (span) of the spectrogram.
:DISPlay:OVlew:SGRam:Y[:SCALE]:OFFSet(?)	Sets the minimum vertical value of the spectrogram (bottom end).
:DISPlay:OVlew:SGRam:Y[:SCALE]:PLINe(?)	Sets the vertical scale of the spectrogram.
:DISPlay:OVlew:WAVEform:X[:SCALE]:OFFSet(?)	Sets the minimum horizontal value (left edge) in the time domain display.
:DISPlay:OVlew:WAVEform:X[:SCALE]:PDIVision(?)	Sets the horizontal scale in the time domain display.
:DISPlay:OVlew:WAVEform:Y[:SCALE]:FIT	Runs auto-scale on the time domain display.
:DISPlay:OVlew:WAVEform:Y[:SCALE]:FULL	Sets the time domain display's vertical axis to the default full-scale.
:DISPlay:OVlew:WAVEform:Y[:SCALE]:OFFSet(?)	Sets the minimum vertical value in the time domain display.
:DISPlay:OVlew:WAVEform:Y[:SCALE]:PDIVision(?)	Sets the vertical scale in the time domain display.

Table 2-14: :DISPlay commands (Cont.)

Header	Description
:DISPlay:PULSe:MVlew SVlew subgroup	The main view and subview related in the pulse measurements
:DISPlay:PULSe:MVlew:RESult:CHPoweR(?)	Determines whether to show channel power measurement results.
:DISPlay:PULSe:MVlew:RESult:DCYClE(?)	Determines whether to show duty cycle measurement results.
:DISPlay:PULSe:MVlew:RESult:EBWidTh(?)	Determines whether to show EBW measurement results.
:DISPlay:PULSe:MVlew:RESult:FREQUency(?)	Determines whether to show frequency deviation measurement results.
:DISPlay:PULSe:MVlew:RESult:OBWidTh(?)	Determines whether to show OBW measurement results.
:DISPlay:PULSe:MVlew:RESult:OORatio(?)	Determines whether to show on/off-ratio measurement results.
:DISPlay:PULSe:MVlew:RESult:PERiod(?)	Determines whether to show repetition interval measurement results.
:DISPlay:PULSe:MVlew:RESult:PHASe(?)	Determines whether to show pulse-pulse phase measurement results.
:DISPlay:PULSe:MVlew:RESult:PPOWer(?)	Determines whether to show peak power measurement results.
:DISPlay:PULSe:MVlew:RESult:RIPPlE(?)	Determines whether to show pulse ripple measurement results.
:DISPlay:PULSe:MVlew:RESult:WIDTh(?)	Determines whether to show pulse width measurement results.
:DISPlay:PULSe:SVlew:FORMat(?)	Selects the display format of the subview.
:DISPlay:PULSe:SVlew:GUIDelines(?)	Determines whether to show the guidelines in the subview.
:DISPlay:PULSe:SVlew:RANGe(?)	Selects how to set the horizontal scale in the subview.
:DISPlay:PULSe:SVlew:RESult(?)	Selects how to show the result graph in the subview.
:DISPlay:PULSe:SVlew:SElect(?)	Selects a pulse to measure.
:DISPlay:PULSe:SPECtrum subgroup	The spectrum view related in the pulse measurements
:DISPlay:PULSe:SPECtrum:X[:SCALe]:OFFSet(?)	Sets the minimum horizontal value (left edge).
:DISPlay:PULSe:SPECtrum:X[:SCALe]:PDIVision(?)	Sets the horizontal scale (per division).
:DISPlay:PULSe:SPECtrum:Y[:SCALe]:FIT	Runs the auto-scale.
:DISPlay:PULSe:SPECtrum:Y[:SCALe]:FULL	Sets the vertical axis to the default full-scale value.
:DISPlay:PULSe:SPECtrum:Y[:SCALe]:OFFSet(?)	Sets the minimum vertical value (bottom).
:DISPlay:PULSe:SPECtrum:Y[:SCALe]:PDIVision(?)	Sets the vertical scale (per division).
:DISPlay:PULSe:WAVEform subgroup	Time domain display related in the pulse measurements
:DISPlay:PULSe:WAVEform:X[:SCALe]:OFFSet(?)	Sets the minimum value of the horizontal axis (left edge).
:DISPlay:PULSe:WAVEform:X[:SCALe]:PDIVision(?)	Sets or queries the horizontal scale (per division).
:DISPlay:PULSe:WAVEform:Y[:SCALe]:FIT	Runs the auto-scale.
:DISPlay:PULSe:WAVEform:Y[:SCALe]:FULL	Sets the vertical axis to the default full-scale value.
:DISPlay:PULSe:WAVEform:Y[:SCALe]:OFFSet(?)	Sets the minimum value (bottom) of the vertical axis.
:DISPlay:PULSe:WAVEform:Y[:SCALe]:PDIVision(?)	Sets the vertical scale (per division).

Table 2-14: :DISPlay commands (Cont.)

Header	Description
:DISPlay:SPEctrum subgroup	Spectrum measurement related.
:DISPlay:SPEctrum:BMARker:STATe(?)	Turns on or off the band power marker.
:DISPlay:SPEctrum:GRATicule:GRID(?)	Determines how the graticule is displayed.
:DISPlay:SPEctrum:MLINe:AMPLitude:INTerval(?)	Sets the interval of the amplitude multi display lines.
:DISPlay:SPEctrum:MLINe:AMPLitude:OFFSet(?)	Sets the offset of the amplitude multi display lines.
:DISPlay:SPEctrum:MLINe:AMPLitude[:STATe](?)	Determines whether to show the amplitude multi display lines.
:DISPlay:SPEctrum:MLINe:ANNOtation[:STATe](?)	Determines whether to show the readout of the multi display lines.
:DISPlay:SPEctrum:MLINe:FREQUency:INTerval(?)	Sets the interval of the frequency multi display lines.
:DISPlay:SPEctrum:MLINe:FREQUency:OFFSet(?)	Sets the offset of the frequency multi display line.
:DISPlay:SPEctrum:MLINe:FREQUency[:STATe](?)	Determines whether to show the frequency multi display lines.
:DISPlay:SPEctrum:X[:SCALe]:OFFSet(?)	Sets the minimum horizontal value (start frequency).
:DISPlay:SPEctrum:X[:SCALe]:PDIVision(?)	Sets the horizontal scale (span/div).
:DISPlay:SPEctrum:Y[:SCALe]:FIT	Runs auto-scale.
:DISPlay:SPEctrum:Y[:SCALe]:FULL	Sets the vertical axis to the default full-scale.
:DISPlay:SPEctrum:Y[:SCALe]:OFFSet(?)	Sets the minimum vertical, or amplitude, value (bottom end).
:DISPlay:SPEctrum:Y[:SCALe]:PDIVision(?)	Sets the vertical, or amplitude, scale per division.
:DISPlay:TFRrequency subgroup	3-dimensional view related.
:DISPlay:TFRrequency:SGRam:COLor[:SCALe]:OFFSet(?)	Sets the minimum color-axis value (bottom end) of the spectrogram.
:DISPlay:TFRrequency:SGRam:COLor[:SCALe]:RANGe(?)	Sets the scale of the spectrogram's color axis.
:DISPlay:TFRrequency:SGRam:MLINe:ANNOtation[:STATe](?)	Determines whether to show the readout of the multi display lines.
:DISPlay:TFRrequency:SGRam:MLINe:FREQUency:INTerval(?)	Sets the interval of the frequency multi display lines.
:DISPlay:TFRrequency:SGRam:MLINe:FREQUency:OFFSet(?)	Sets the offset of the frequency multi display lines.
:DISPlay:TFRrequency:SGRam:MLINe:FREQUency[:STATe](?)	Determines whether to show the frequency multi display lines.
:DISPlay:TFRrequency:SGRam:MLINe:TIME:INTerval(?)	Sets the interval of the time multi display lines.
:DISPlay:TFRrequency:SGRam:MLINe:TIME:OFFSet(?)	Sets the offset of the time multi display lines.
:DISPlay:TFRrequency:SGRam:MLINe:TIME[:STATe](?)	Determines whether to show the time multi display lines.
:DISPlay:TFRrequency:SGRam:X[:SCALe]:OFFSet(?)	Sets the minimum horizontal value (left end) of the spectrogram.
:DISPlay:TFRrequency:SGRam:X[:SCALe]:SPAN(?)	Sets the horizontal full-scale (span) of the spectrogram.
:DISPlay:TFRrequency:SGRam:Y[:SCALe]:OFFSet(?)	Sets the minimum vertical value (bottom end) of the spectrogram.
:DISPlay:TFRrequency:SGRam:Y[:SCALe]:PLINe(?)	Sets the vertical scale of the spectrogram.

Table 2-14: :DISPlay commands (Cont.)

Header	Description
:DISPlay[:VIEW] subgroup	General conditions about display.
:DISPlay[:VIEW]:BRIGhtness(?)	Sets the display brightness.
:DISPlay[:VIEW]:FORMat(?)	Selects the view display format.
:DISPlay:WAVeform subgroup	Time domain display related.
:DISPlay:WAVeform:X[:SCALE]:OFFSet(?)	Sets the minimum horizontal, or time, value (left end).
:DISPlay:WAVeform:X[:SCALE]:PDIVision(?)	Sets the horizontal, or time, scale per division.
:DISPlay:WAVeform:Y[:SCALE]:FIT	Runs auto-scale.
:DISPlay:WAVeform:Y[:SCALE]:FULL	Sets the vertical axis to the default full-scale.
:DISPlay:WAVeform:Y[:SCALE]:OFFSet(?)	Sets the minimum vertical, or amplitude, value (bottom end).
:DISPlay:WAVeform:Y[:SCALE]:PDIVision(?)	Sets the vertical, or amplitude, scale.

:FETCh Commands

The :FETCh commands retrieve the measurements from the data taken by the latest INITiate command.

If you want to perform a FETCh operation on fresh data, use the :READ commands, which acquire a new input signal and fetch the measurement results from that data.

Table 2-15: :FETCh commands

Header	Description
:FETCh:ADEMod:AM?	Returns the AM signal analysis results in time series.
:FETCh:ADEMod:AM:RESult?	Returns the AM signal analysis results.
:FETCh:ADEMod:FM?	Returns the FM signal analysis results in time series.
:FETCh:ADEMod:FM:RESult?	Returns the FM signal analysis results.
:FETCh:ADEMod:PM?	Returns the PM signal analysis results in time series.
:FETCh:CCDF?	Returns the CCDF measurement results.
:FETCh:DDEMod? (Option 21 only)	Returns the digital modulation analysis measurement results.
:FETCh:DISTRibution:CCDF?	Returns the CCDF trace data.
:FETCh:OVleW?	Returns the maximum and minimum of waveform on the overview.
:FETCh:PULSe?	Returns the result of the pulse characteristics analysis.
:FETCh:PULSe:SPECTrum?	Returns the spectrum data of the frequency domain measurement.
:FETCh:PULSe:TAMPLitude?	Returns the time domain amplitude data.
:FETCh:PULSe:TFRequency?	Returns the frequency deviation measurement results.

Table 2-15: :FETCh commands (Cont.)

Header	Description
:FETCh:SPECTrum?	Returns spectrum waveform data.
:FETCh:SPECTrum:ACPower?	Returns the ACPR measurement results.
:FETCh:SPECTrum:CFRequency?	Returns the carrier frequency measurement results.
:FETCh:SPECTrum:CHPower?	Returns the channel power measurement results.
:FETCh:SPECTrum:CNRatio?	Returns the C/N measurement results.
:FETCh:SPECTrum:EBWidth?	Returns the emission bandwidth measurement results.
:FETCh:SPECTrum:OBWidth?	Returns the OBW measurement results.
:FETCh:SPECTrum:SPURious?	Returns the spurious signal measurement results.
:FETCh:TRANSient:FVTime?	Returns the frequency vs. time measurement results.
:FETCh:TRANSient:IQVTime?	Returns the I/Q level vs. time measurement results.
:FETCh:TRANSient:PVTime?	Returns the power vs. time measurement results.

:FORMat Commands

Define the data output format.

Table 2-16: :FORMat commands

Header	Description
:FORMat:BORDER(?)	Selects the byte order of output data.
:FORMat[:DATA](?)	Selects the data format for output.

:HCOPY Commands

Control hardcopy of the screen.

Table 2-17: :HCOPY commands

Header	Description
:HCOPY:BACKground	Selects the hardcopy background color.
:HCOPY:DESTination	Selects the hardcopy output destination.
:HCOPY[:IMMEDIATE]	Outputs the hardcopy to the specified printer.

:INITiate Commands

Control data acquisition.

Table 2-18: :INITiate commands

Header	Description
:INITiate:CONTinuous(?)	Determines whether to acquire data continuously.
:INITiate[:IMMediate]	Starts data acquisition.
:INITiate:REStart	Restarts data acquisition.

:INPut Commands

Control the characteristics of the signal input.

Table 2-19: :INPut commands

Header	Description
:INPut:ALEVel	Adjusts amplitude automatically for the best system performance.
:INPut:ATTenuation(?)	Sets the input attenuation.
:INPut:ATTenuation:AUTO(?)	Determines whether to set the input attenuation automatically.
:INPut:COUPLing(?) (Option 03 only)	Switches the input coupling in the IQ input mode.
:INPut:MIXer(?)	Sets the mixer level.
:INPut:MLEVel(?)	Sets the reference level.

:INSTrument Commands

Sets the measurement mode for the analyzer.

Table 2-20: :INSTrument commands

Header	Description
:INSTrument:CATalog?	Queries all the measurement modes that the analyzer has.
:INSTrument[:SElect]	Selects the measurement mode.

:MMEMory Commands

Manipulates files residing on the internal hard disk or floppy disk.

Table 2-21: :MMEMory commands

Header	Description
:MMEMory:COpy	Copies the contents of a file to another.
:MMEMory:DELeTe	Deletes a file.
:MMEMory:LOAD:CORRection	Loads the correction table from a file.
:MMEMory:LOAD:IQT	Loads the IQ data from a file.
:MMEMory:LOAD:STATe	Loads the analyzer settings from a file.
:MMEMory:LOAD:TRACe	Loads trace data from a file.
:MMEMory:NAME	Specifies the file name for hard copy output.
:MMEMory:STORe:CORRection	Stores an amplitude correction table in a file.
:MMEMory:STORe:IQT	Stores IQ data in a file.
:MMEMory:STORe:PULSe	Stores the pulse measurement results in a file.
:MMEMory:STORe:STABLe	Stores a symbol table in a file.
:MMEMory:STORe:STATe	Stores the analyzer settings in a file.
:MMEMory:STORe:TRACe	Stores trace data in a file.

:PROGram Commands

Control macro programs.

Table 2-22: :PROGram commands

Header	Description
:PROGram:CATalog?	Queries the list of macro programs.
:PROGram[:SELeCted]:DELeTe[:SELeCted]	Deletes a macro program.
:PROGram[:SELeCted]:EXECute	Runs a macro program.
:PROGram[:SELeCted]:NAME(?)	Specifies a macro program.
:PROGram:NUMBer(?)	Sets numeric variables for a program.
:PROGram:STRing(?)	Sets character variables for a program.

:READ Commands

The :READ commands acquire an input signal once in the single mode and obtain the measurement results from that data.

If you want to fetch the measurement results from the data currently residing in the memory without acquiring the input signal, use the :FETCh commands.

Table 2-23: :READ commands

Header	Description
:READ:ADEMod:AM?	Returns the AM signal analysis results in time series.
:READ:ADEMod:AM:RESult?	Returns the AM signal analysis results.
:READ:ADEMod:FM?	Returns the FM signal analysis results in time series.
:READ:ADEMod:FM:RESult?	Returns the FM signal analysis results.
:READ:ADEMod:PM?	Returns the PM signal analysis results in time series.
:READ:CCDF?	Returns the CCDF measurement results.
:READ:DDEMod? (Option 21 only)	Returns the digital modulation analysis measurement results.
:READ:DISTRibution:CCDF?	Returns the CCDF trace data.
:READ:OVlew?	Returns the maximum and minimum of waveform on the overview.
:READ:PULSe?	Returns the result of the pulse characteristics analysis.
:READ:PULSe:SPECTrum?	Returns the spectrum data of the frequency domain measurement.
:READ:PULSe:TAMPlitude?	Returns the time domain amplitude data.
:READ:PULSe:TFrequency?	Returns the frequency deviation measurement results.
:READ:SPECTrum?	Returns spectrum waveform data.
:READ:SPECTrum:ACPower?	Returns the ACPR measurement results.
:READ:SPECTrum:CFrequency?	Returns the carrier frequency measurement results.
:READ:SPECTrum:CHPower?	Returns the channel power measurement results.
:READ:SPECTrum:CNRatio?	Returns the C/N measurement results.
:READ:SPECTrum:EBWidth?	Returns the emission bandwidth measurement results.
:READ:SPECTrum:OBWidth?	Returns the OBW measurement results.
:READ:SPECTrum:SPURious?	Returns the spurious signal measurement results.
:READ:TRANSient:FVTime?	Returns the frequency vs. time measurement results.
:READ:TRANSient:IQVTime?	Returns the I/Q level vs. time measurement results.
:READ:TRANSient:PVTime?	Returns the power vs. time measurement results.

:SENSe Commands

Set the detailed measurement conditions.

Table 2-24: :SENSe commands

Header	Description
:SENSe:ACPower subgroup	ACPR measurement related.
:SENSe:ACPower:BANDwidth BWIDTH:ACHannel(?)	Sets the bandwidth of the next adjacent channel.
:SENSe:ACPower:BANDwidth BWIDTH:INTEgration(?)	Sets the bandwidth of the main channel.
:SENSe:ACPower:CSPacing(?)	Sets the channel-to-channel spacing.
:SENSe:ACPower:FILTer:COEFFicient(?)	Sets the filter factor.
:SENSe:ACPower:FILTer:TYPE(?)	Selects a filter.
:SENSe:ADEMod subgroup	Analog modulation analysis related.
:SENSe:ADEMod:BLOCK(?)	Sets the number of the block to be measured.
:SENSe:ADEMod:CARRier:OFFSet(?)	Sets the carrier frequency offset in the FM signal analysis.
:SENSe:ADEMod:CARRier:SEARch(?)	Determines whether to detect the FM carrier automatically.
:SENSe:ADEMod:FM:THReshold(?)	Sets the threshold level to determine a burst in the FM analysis.
:SENSe:ADEMod[:IMMEdiate]	Runs the analog modulation analysis.
:SENSe:ADEMod:LENGth(?)	Sets the length of the measurement range.
:SENSe:ADEMod:MODulation(?)	Selects the modulation.
:SENSe:ADEMod:OFFSet(?)	Sets the measurement start position.
:SENSe:ADEMod:PM:THReshold(?)	Sets the threshold level to determine a burst in the PM analysis.
:SENSe:AVERage subgroup	Averaging related.
:SENSe:AVERage:CLEar	Restarts the averaging from the beginning.
:SENSe:AVERage:COUNT(?)	Sets the number of averages.
:SENSe:AVERage[:STATe](?)	Turns on or off averaging.
:SENSe:AVERage:TCONtrol(?)	Selects the operation when the number of averages is reached.
:SENSe:BSIZe subgroup	Block size setting.
:SENSe:BSIZe(?)	Sets the block size.
CCDF subgroup	CCDF measurement related.
:SENSe:CCDF:BLOCK(?)	Sets the number of the block to be measured.
:SENSe:CCDF:CLEar	Restarts the measurement from the beginning.
:SENSe:CCDF:RMEasurement(?)	Clears the CCDF accumulator and restarts the measurement..
:SENSe:CCDF:THReshold(?)	Sets the threshold to include the samples in the CCDF calculation.
:SENSe:CFRequency subgroup	Carrier frequency measurement related.
:SENSe:CFRequency:CRESolution(?)	Sets the counter resolution.

Table 2–24: :SENSe commands (Cont.)

Header	Description
[[:SENSe]:CHPower subgroup	Channel power measurement related.
[[:SENSe]:CHPower:BANDwidth BWIDth:INTegration(?)]	Sets the channel bandwidth.
[[:SENSe]:CHPower:FILTer:COEFFicient(?)]	Sets the filter roll-off rate.
[[:SENSe]:CHPower:FILTer:TYPE(?)]	Selects the filter.
[[:SENSe]:CNRatio subgroup	Carrier-to-Noise (C/N) measurement related.
[[:SENSe]:CNRatio:BANDwidth BWIDth:INTegration(?)]	Sets the measurement bandwidth.
[[:SENSe]:CNRatio:BANDwidth BWIDth:NOISe(?)]	Sets the noise bandwidth.
[[:SENSe]:CNRatio:FILTer:COEFFicient(?)]	Sets the filter roll-off rate.
[[:SENSe]:CNRatio:FILTer:TYPE(?)]	Selects the filter.
[[:SENSe]:CNRatio:OFFSet(?)]	Sets the offset frequency.
[[:SENSe]:CORRection subgroup	Amplitude correction related.
[[:SENSe]:CORRection:DATA(?)]	Sets amplitude correction data.
[[:SENSe]:CORRection:DELeTe]	Deletes amplitude correction data.
[[:SENSe]:CORRection:OFFSet[:MAGNitude](?)	Sets amplitude offset.
[[:SENSe]:CORRection:OFFSet:FREQuency(?)]	Sets frequency offset.
[[:SENSe]:CORRection[:STATe](?)	Turns on or off amplitude correction.
[[:SENSe]:CORRection:X:SPACing(?)]	Selects scaling of the horizontal axis (frequency) for interpolation.
[[:SENSe]:CORRection:Y:SPACing(?)]	Selects scaling of the vertical axis (amplitude) for interpolation.
[[:SENSe]:DDEMod subgroup (Option 21 only)	Digital modulation analysis related.
[[:SENSe]:DDEMod:BLOCK(?)]	Sets the number of the block to be measured.
[[:SENSe]:DDEMod:CARRier:OFFSet(?)]	Sets the carrier frequency offset.
[[:SENSe]:DDEMod:CARRier:SEARch(?)]	Determines whether to detect the carrier automatically.
[[:SENSe]:DDEMod:DECode(?)]	Selects the method that is used to decode the data bits.
[[:SENSe]:DDEMod:FDEVIation(?)]	Sets the frequency deviation to determine two states for FSK.
[[:SENSe]:DDEMod:FDEVIation:AUTO(?)]	Selects whether to detect the frequency deviation automatically.
[[:SENSe]:DDEMod:FILTer:ALPHa(?)]	Sets the filter factor (α/BT).
[[:SENSe]:DDEMod:FILTer:MEASurement(?)]	Selects the measurement filter.
[[:SENSe]:DDEMod:FILTer:REFerence(?)]	Selects the reference filter.
[[:SENSe]:DDEMod:FORMat(?)]	Selects the modulation.
[[:SENSe]:DDEMod[:IMMediate]	Starts the digital modulation calculation.
[[:SENSe]:DDEMod:LENGth(?)]	Sets the measurement range.
[[:SENSe]:DDEMod:MDEPth(?)]	Sets the modulation depth to separate two states in ASK.
[[:SENSe]:DDEMod:MDEPth:AUTO(?)]	Determines whether to detect the modulation depth automatically.

Table 2-24: :SENSe commands (Cont.)

Header	Description
[:SENSe]:DDEMod:NLINearity:COEFFicient(?)	Sets the maximum order of the best-fit curve polynomial.
[:SENSe]:DDEMod:NLINearity:HDIVision(?)	Sets the horizontal interval between display points.
[:SENSe]:DDEMod:NLINearity:LSRegion[:SET](?)	Sets the linear signal region.
[:SENSe]:DDEMod:NLINearity:LSRegion:UNIT(?)	Selects the unit to set the liner signal region.
[:SENSe]:DDEMod:OFFSet(?)	Sets the measurement start position.
[:SENSe]:DDEMod:PRESet(?)	Sets the default settings by the communication standard.
[:SENSe]:DDEMod:SRATe(?)	Sets the symbol rate.
[:SENSe]:EBWidth subgroup	EBW measurement related.
[:SENSe]:EBWidth:XDB(?)	Sets the relative power from the peak for the measurement.
[:SENSe]:FEED subgroup	Input port related.
[:SENSe]:FEED	Selects the input port (RF, IQ, or calibration signal).
[:SENSe]:FREQuency subgroup	Frequency related.
[:SENSe]:FREQuency:BAND?	Queries the measurement frequency band.
[:SENSe]:FREQuency:CENTer(?)	Sets the center frequency.
[:SENSe]:FREQuency:CENTer:STEP:AUTO(?)	Determines whether to set the step size automatically by span.
[:SENSe]:FREQuency:CENTer:STEP[:INCRement](?)	Sets the step size of the center frequency.
[:SENSe]:FREQuency:CHANnel(?)	Selects a channel.
[:SENSe]:FREQuency:CTABLE:CATalog?	Queries the available channel tables.
[:SENSe]:FREQuency:CTABLE[:SELect](?)	Selects a channel table.
[:SENSe]:FREQuency:SPAN(?)	Sets the span.
[:SENSe]:FREQuency:STARt(?)	Sets the start frequency.
[:SENSe]:FREQuency:STOP(?)	Sets the stop frequency.
[:SENSe]:OBWidth subgroup	OBW measurement related.
[:SENSe]:OBWidth:PERCent(?)	Sets the occupied bandwidth.
[:SENSe]:PULSe subgroup	Pulse characteristics analysis related
[:SENSe]:PULSe:BLOCK(?)	Sets the number of the block to measure.
[:SENSe]:PULSe:CHPower:BANDwidth[:BWIDTH:INTEgration](?)	Sets the channel bandwidth for the channel power measurement.
[:SENSe]:PULSe:CRESolution(?)	Sets the frequency measurement resolution.
[:SENSe]:PULSe:EBWidth:XDB(?)	Sets the level at which the EBW is measured.
[:SENSe]:PULSe:FFT:COEFFicient(?)	Sets the roll-off ratio for the Nyquist FFT window.
[:SENSe]:PULSe:FFT:WINDow[:TYPE](?)	Selects the FFT window type.
[:SENSe]:PULSe:FILTer:BANDwidth[:BWIDTH](?)	Sets the bandwidth of the time measurement filter.
[:SENSe]:PULSe:FILTer:COEFFicient(?)	Sets the a/BT value for the Gaussian measurement filter.
[:SENSe]:PULSe:FILTer:MEASuerment(?)	Selects the measurement filter for the time measurement.
[:SENSe]:PULSe:FREQuency:OFFSet(?)	Sets the frequency offset.

Table 2-24: :SENSe commands (Cont.)

Header	Description
[[:SENSe]:PULSe:FREQuency:RECOvery(?)]	Selects the frequency recovery.
[[:SENSe]:PULSe:IMMEdiate(?)]	Runs calculation for acquired data.
[[:SENSe]:PULSe:OBWIdth:PERcent(?)]	Sets OBW for the OBW measurement.
[[:SENSe]:PULSe:PTOFfset(?)]	Sets the time offset for the pulse-pulse phase measurement point.
[[:SENSe]:PULSe:THReshold(?)]	Sets the threshold level to detect pulses in acquired data.
[[:SENSe]:ROSCillator subgroup]	Reference oscillator related.
[[:SENSe]:ROSCillator:SOURce(?)]	Selects the reference oscillator.
[[:SENSe]:SPECtrum subgroup]	Spectrum related.
[[:SENSe]:SPECtrum:AVERage:CLEar]	Restarts the average process.
[[:SENSe]:SPECtrum:AVERage:COUNt(?)]	Sets the number of averages.
[[:SENSe]:SPECtrum:AVERage[:STATe](?)]	Turns on or off averaging.
[[:SENSe]:SPECtrum:AVERage:TYPE(?)]	Selects the average type.
[[:SENSe]:SPECtrum:BANdwidth BWIDth[:RESolution](?)]	Sets the resolution bandwidth.
[[:SENSe]:SPECtrum:BANdwidth BWIDth[:RESolution]:AUTO(?)]	Determines whether to automatically set the resolution bandwidth.
[[:SENSe]:SPECtrum:BANdwidth BWIDth:STATe(?)]	Turns on or off the resolution bandwidth calculation process.
[[:SENSe]:SPECtrum:DETEctor[:FUNction](?)]	Determines how the trace is compressed.
[[:SENSe]:SPECtrum:FILTer:COEFFicient(?)]	Sets the filter roll-off rate.
[[:SENSe]:SPECtrum:FILTer:TYPE(?)]	Selects the filter.
[[:SENSe]:SPECtrum:FFT:ERESolution(?)]	Determines whether to enable the extended resolution.
[[:SENSe]:SPECtrum:FFT:LENGth(?)]	Sets the number of FFT sample points.
[[:SENSe]:SPECtrum:FFT:STARt(?)]	Sets the time interval between 1024-point overlapped FFT frames.
[[:SENSe]:SPECtrum:FFT:WINDow[:TYPE](?)]	Selects a FFT window.
[[:SENSe]:SPECtrum:FRAMe(?)]	Sets the frame number for the spectrum measurement.
[[:SENSe]:SPECtrum:MEASurement(?)]	Runs a selected measurement item.
[[:SENSe]:SPURious subgroup]	Spurious signal measurement related.
[[:SENSe]:SPURious:THReshold:EXCURsion(?)]	Sets the spurious excursion level.
[[:SENSe]:SPURious:THReshold:IGNore(?)]	Sets an area to ignore spurious.
[[:SENSe]:SPURious:THReshold:SIGNal(?)]	Sets the carrier criterion level.
[[:SENSe]:SPURious:THReshold:SPURious(?)]	Sets the spurious criterion level.
[[:SENSe]:TRANsient subgroup]	Time analysis related.
[[:SENSe]:TRANsient:BLock(?)]	Sets the number of the block to be measured.
[[:SENSe]:TRANsient:IMMEdiate]	Starts a time characteristic analysis.
[[:SENSe]:TRANsient:ITEM(?)]	Selects a measurement item.
[[:SENSe]:TRANsient:LENGth(?)]	Sets the length of the measurement range.
[[:SENSe]:TRANsient:OFFSet(?)]	Sets the measurement start position.

:STATus Commands

Control registers defined in the SCPI status reporting structure.

Table 2-25: :STATus commands

Header	Description
:STATus:OPERation:CONDition?	Queries the contents of the OCR.
:STATus:OPERation:ENABle(?)	Sets the mask for the OENR.
:STATus:OPERation[:EVENT]?	Queries the contents of the OEVR.
:STATus:OPERation:NTRansition(?)	Sets the value of the negative transition filter.
:STATus:OPERation:PTRansition(?)	Sets the value of the positive transition filter.
:STATus:PRESet	Presets a status byte.
:STATus:QUEStionable:CONDition?	Queries the contents of the QCR.
:STATus:QUEStionable:ENABle(?)	Sets the mask for the OENR.
:STATus:QUEStionable[:EVENT]?	Queries the contents of the QER.
:STATus:QUEStionable:NTRansition(?)	Sets the value of the negative transition filter.
:STATus:QUEStionable:PTRansition(?)	Sets the value of the positive transition filter.

:SYSTem Commands

Set the system parameters and query system information.

Table 2-26: :SYSTem commands

Header	Description
:SYSTem:DATE(?)	Sets the current date.
:SYSTem:ERRor:ALL?	Queries all the error or event information.
:SYSTem:ERRor:CODE:ALL?	Queries all the error or event codes.
:SYSTem:ERRor:CODE[:NEXT]?	Queries the latest error or event codes.
:SYSTem:ERRor:COUNt?	Queries the number of errors or events.
:SYSTem:ERRor[:NEXT]?	Queries the latest error or event information.
:SYSTem:KLOCK(?)	Determine whether to lock or unlock the front panel keys.
:SYSTem:OPTions?	Queries optional information.
:SYSTem:PRESet	Presets the analyzer.
:SYSTem:TIME(?)	Sets the current time.
:SYSTem:VERSion?	Queries the version of the SCPI.

:TRACe Commands

Set up display of Trace 1 and 2.

Table 2-27: :TRACe commands

Header	Description
:TRACe<x> :DATA<x>:AVERAge:CLEAr	Restarts trace averaging.
:TRACe<x> :DATA<x>:AVERAge:COUnT(?)	Sets the number of traces to combine for averaging.
:TRACe<x> :DATA<x>:DDETEctor(?)	Selects the display detector.
:TRACe<x> :DATA<x>:MODE(?)	Selects the way to display the traces.

:TRIGger Commands

Set up the trigger.

Table 2-28: :TRIGger commands

Header	Description
:TRIGger[:SEQuence]:LEVel:IF(?)	Sets the IF trigger level.
:TRIGger[:SEQuence]:LEVel:IQFRequency(?)	Sets the IQ frequency trigger level (Option 02 only).
:TRIGger[:SEQuence]:LEVel:IQTime(?)	Sets the IQ time trigger level (Option 02 only).
:TRIGger[:SEQuence]:MODE(?)	Selects the trigger mode.
:TRIGger[:SEQuence]:MPOStion?	Queries the trigger occurrence point in one block data on the memory.
:TRIGger[:SEQuence]:OPOStion?	Queries the trigger output point.
:TRIGger[:SEQuence]:POStion(?)	Sets the trigger position.
:TRIGger[:SEQuence]:SLOPe(?)	Selects the trigger slope.
:TRIGger[:SEQuence]:SOURce(?)	Selects the trigger source.

:UNIT Commands

Specify fundamental units for measurement.

Table 2-29: :UNIT commands

Header	Description
:UNIT:ANGLE(?)	Specifies the fundamental unit of angle.

General Programming Procedure

You should generally use the following procedure to script a program:

1. *Setting the measurement mode*

Using an :INSTrument command, select a measurement mode to set the basic conditions.

[Example] :INSTrument:SElect "SANORMAL"

Selects the normal spectrum analysis mode to set the basic conditions.

2. *Setting the measurement item*

Using a :CONFIgure command, select a measurement item to set up the analyzer to the defaults.

[Example] :CONFIgure:SPECTrum:CHPower

Sets up the analyzer to the channel power measurement defaults.

3. *Detailed settings*

Use :SENSe commands to set details for the measurement session.

[Example] :SENSe:CHPower:BWIDth:INTEgration 3MHz

Sets the channel power measurement range to 3 MHz.

4. *Acquiring data*

Use an :INITiate or :ABORt command to initiate or stop data acquisition.

[Example] :INITiate:CONTinuous ON

Initiates data acquisition in continuous mode.

To save or load the acquired data and settings, use an :MMEMory command.

[Example] :MMEMory:STORe:IQT "DATA1"

Saves the acquired data in file DATA1.IQT.

5. *Obtaining the measurement results*

Use a :FETCh or :READ command to obtain the measurement results.

[Example] :FETCh:SPECTrum:CHPower?

Returns the channel power measurement results.

6. *Display*

Use :DISPlay commands to set the display-related conditions.

[Example] :DISPlay:SPECTrum:X:SCALE:OFFSet 800MHz

Sets 800 MHz for the minimum (left) edge of the horizontal axis in the spectrum view.

Also refer to Chapter 4, *Programming Examples*.

Appendix C lists the default settings of the commands.

IEEE Common Commands

This section details the IEEE common commands.

Command Tree

Header	Parameter
*CAL?	
*CLS	
*ESE	<value>
*ESR?	
*IDN?	
*OPC	
*OPT?	
*RST	
*SRE	<value>
*STB?	
*TRG	
*TST?	
*WAI	

***CAL? (Query Only)**

Runs the following three calibrations and returns the results indicating whether they have ended normally.

RF gain calibration
Center offset calibration
DC offset calibration (if the measurement frequency band is the baseband)

This command is equivalent to the :CALibration[:ALL]? query command.

NOTE. *The entire calibration process takes several minutes to several dozen minutes. Wait for a response from a *CAL query. Every command you attempt to send during this period is rejected.*

Syntax	*CAL?
Arguments	None
Returns	<NR1> 0 indicates a normal end. For details of the error codes, refer to page 3–17.
Measurement Modes	All
Examples	*CAL? runs a calibration and might return 0, indicating that the calibration has ended normally.
Related Commands	:CALibration[:ALL]

***CLS (No Query Form)**

Clears all the event status registers and queues used in the status/event reporting structure. Refer to Section 3, *Status and Events*, for the register information.

Syntax *CLS

Arguments None

Measurement Modes All

Examples *CLS
clears all the event status registers and queues.

Related Commands *ESE, *ESR, *SRE, *STB?

***ESE (?)**

Sets or queries the value of the Event Status Enable Register (ESER) used in the status/event reporting structure. Refer to Section 3, *Status and Events*, for the register information.

Syntax *ESE <value>

*ESE?

Arguments <value>::=<NR1> is a value in the range from 0 through 255. The binary bits of the ESER are set according to this value.

Measurement Modes All

Examples *ESE 145
sets the ESER to binary 10010001, which enables the PON, EXE, and OPC bits.

*ESE?
might return the string *ESE 184, showing that the ESER contains the binary value 10111000.

Related Commands *CLS, *ESR, *SRE, *STB?

***ESR? (Query Only)**

Sets or queries the contents of the Standard Event Status Register (SESR) used in the status/event reporting structure. The SESR is cleared after being read. Refer to Section 3, *Status and Events*, for the register information.

Syntax *ESR?

Arguments None

Returns <NR1> representing the contents of the SESR by a 0 to 255 decimal number.

Measurement Modes All

Examples *ESR?
might return the value 213, showing that the SESR contains binary 11010101.

Related Commands *CLS, *ESE?, *SRE, *STB?

***IDN? (Query Only)**

Returns the analyzer's identification code.

Syntax *IDN?

Arguments None

Returns The analyzer identification code in the following format:

TEKTRONIX,RSA330XA,<serial_number>,<firmware_version>

Where

TEKTRONIX indicates that the manufacturer is Tektronix.

RSA330XA is RSA3303A or RSA3308A, depending on the model.

<serial_number> is the serial number.

<firmware_version> is the firmware version.

Measurement Modes All

Examples *IDN?
might return TEKTRONIX,RSA2208A,J300101,1.20 as the analyzer's identification code.

***OPC (?)**

Generates the operation complete message in the Standard Event Status Register (SESR) when all pending operations finish. The *OPC? query places the ASCII character "1" into the output queue when all pending operations are finished. The *OPC? response is not available to read until all pending operations finish.

The *OPC command allows you to synchronize the operation of the analyzer with your application program. Refer to *Synchronizing Execution* on page 3–14 for the details.

Syntax *OPC

*OPC?

Arguments None

Measurement Modes All

***OPT? (Query Only)**

Queries the options installed in the analyzer.

Syntax *OPT?

Arguments None

Returns The numbers of all the options installed in the analyzer, separated by commas. If no options have been installed, 0 is returned.

Measurement Modes All

Examples *OPT?
might return 02,03,21, indicating that Option 02, 03, and 21 are currently installed in the analyzer.

*RST (No Query Form)

Restores the analyzer to the factory default settings. For the actual settings, refer to *Appendix C: Factory Initialization Settings*. This command is equivalent to a pair of commands :SYSTem:PRESet and *CLS that run successively.

The *RST command does not alter the following:

- The state of the IEEE Std 488.1–1987 interface.
- The selected IEEE Std 488.1–1987 address of the analyzer.
- Measurement mode selected with the :INSTrument[:SELEct] command
- Calibration data that affect device specifications.
- The Output Queue.
- The Service Request Enable Register setting.
- The Standard Event Status Enable Register setting.
- The Power-on status clear flag setting.
- Stored settings.

Syntax *RST

Arguments None

Measurement Modes All

Examples *RST
resets the analyzer.

Related Commands *CLS, :INSTrument[:SELEct], :SYSTem:PRESet

***SRE (?)**

Sets or queries the value of the Service Request Enable Register (SRER) used in the status/event reporting structure. Refer to Section 3, *Status and Events*, for the register information.

Syntax *SRE <value>
 *SRE?

Arguments <value> ::= <NR1> is a value in the range from 0 to 255. The binary bits of the SRER are set according to this value. Using an out-of-range value causes an execution error.

Measurement Modes All

Examples *SRE 48
 sets binary 00110000 in the SRER's bits:

 *SRE?
 might return 32, indicating that binary value 00100000 has been set in the SRER's bits.

Related Commands *CLS, *ESE, *ESR?, *STB?

*STB? (Query Only)

Returns the contents of the Status Byte Register (SBR) in the status/event reporting structure using the Master Summary Status (MSS) bit. Refer to Section 3, *Status and Events*, for the register information.

Syntax	*STB?
Arguments	None
Returns	<NR1> representing the contents of the SBR as a decimal number.
Measurement Modes	All
Examples	*STB? might return 96, indicating that the SBR contains binary 0110 0000.
Related Commands	*CLS, *ESE, *ESR?, *SRE

*TRG (No Query Form)

Generates a trigger signal.
This command is equivalent to the :INITiate[:IMMEDIATE] command.

Syntax	*TRG
Arguments	None
Measurement Modes	All
Examples	*TRG generates a trigger signal.
Related Commands	:INITiate[:IMMEDIATE]

***TST? (Query Only)**

Runs a self test and returns the result.

NOTE. *The analyzer does not run any self test. It returns 0 whenever a *TST command is sent.*

Syntax	*TST?
Arguments	None
Returns	<NR1>. Always 0.
Measurement Modes	All
Related Commands	*CAL?, CALibration[:ALL]

***WAI (No Query Form)**

Prevents the analyzer from executing further commands or queries until all pending operations finish. This command allows you to synchronize the operation of the analyzer with your application program. For the details, refer to *Synchronizing Execution* on page 3–14.

Syntax	*WAI
Arguments	None
Measurement Modes	All
Related Commands	*OPC

:ABORt Commands

Resets the trigger system and related actions such as data acquisition and measurement.

Command Tree

Header	Parameter
:ABORt	

:ABORt (No Query Form)

Resets the trigger system and related actions such as data acquisition and measurement.

NOTE. *You must have acquired data using the :INITiate:CONTinuous command (refer to page 2–214) before you can execute the :ABORt command.*

The command function depends on the acquisition mode as follows.

For single acquisition mode:

The :ABORt command forcibly stops data acquisition.

To stop the acquisition because the trigger does not occur in the single mode, send this command:

```
:INITiate:CONTinuous OFF
```

For continuous acquisition mode:

The :ABORt command initiates a new session of data acquisition in the continuous mode.

To stop the acquisition in the continuous mode, send this command:

```
:INITiate:CONTinuous OFF
```

Syntax	:ABORt
Arguments	None
Measurement Modes	All
Examples	:ABORt resets the trigger system and related actions such as data acquisition and measurement.
Related Commands	:INITiate:CONTinuous

:CALCulate Commands

The :CALCulate commands control the marker and the display line. The views are identified with :CALCulate<x> in the command header (see Figure 2–5).

- :CALCulate1: View 1
- :CALCulate2: View 2 (NOTE: currently not used)
- :CALCulate3: View 3
- :CALCulate4: View 4

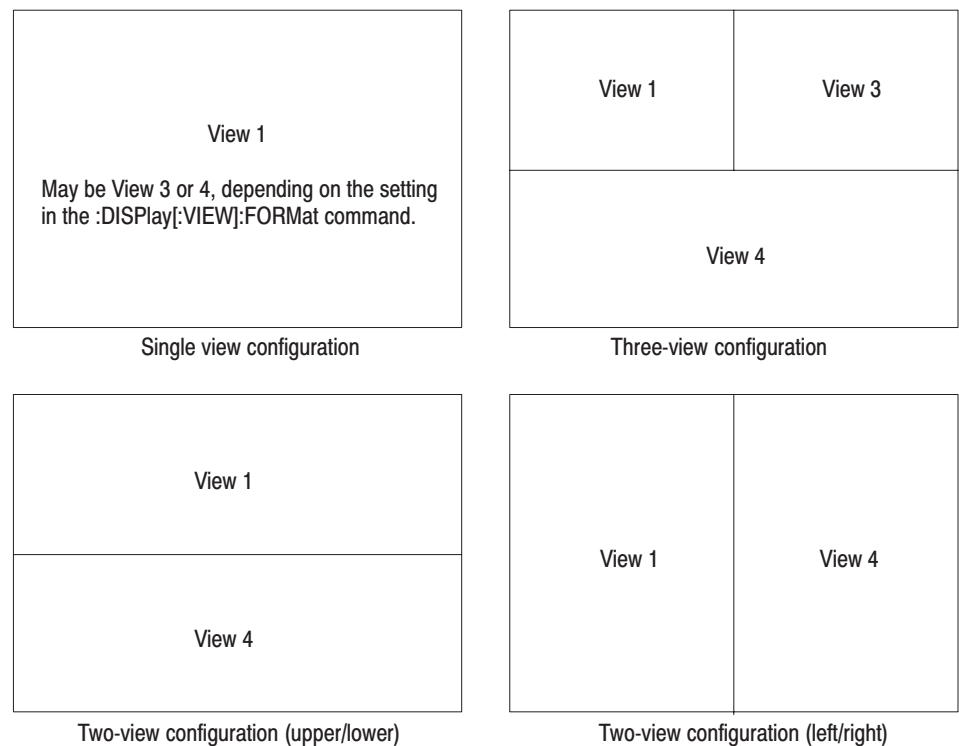

Figure 2–5: View number assignments

For details on the marker and the display line, refer to the *RSA3303A and RSA3308A User Manual*.

Command Tree

Header	Parameter
:CALCulate<x>	
:DLINe<y>	<numeric_value>
:STATe	<boolean>
:MARKer<y>	
:AOFF	
:MAXimum	
:MODE	POSition DELTa
:PEAK	
:HIGHer	
:LEFT	
:LOWer	
:RIGHT	
:PTHReshold	<numeric_value>
:ROFF	
[:SET]	
:CENTer	
:MEASurement	
:RCURsor	
[:STATe]	<boolean>
:T	<numeric_value>
:TOGGle	
:TRACe	MAIN SUB
:X	<numeric_value>
:Y	<numeric_value>
:VLINe<y>	<numeric_value>
:STATe	<boolean>

:CALCulate<x>:DLINe<y> (?)

Sets or queries the vertical position of the horizontal line.

Syntax :CALCulate<x>:DLINe<y> <value>
:CALCulate<x>:DLINe<y>?

Arguments <value>::=<NRf> specifies the vertical position of the horizontal line.
Range: -200 to +100 dBm

Measurement Modes SANORMAL, SASGRAM, SARTIME

Examples :CALCulate1:DLINe1 -20
positions Horizontal Line 1 at -20 dBm in View 1.

Related Commands :CALCulate<x>:DLINe<y>:STATe

:CALCulate<x>:DLINe<y>:STATe (?)

Determines whether to turn on or off the horizontal line.

Syntax :CALCulate<x>:DLINe<y>:STATe { OFF | ON | 0 | 1 }
:CALCulate<x>:DLINe<y>:STATe?

Arguments OFF or 0 hides the horizontal line.
ON or 1 shows the horizontal line.

Measurement Modes SANORMAL, SASGRAM, SARTIME

Examples :CALCulate1:DLINe2:STATe 1
shows Horizontal Line 2 in View 1.

:CALCulate<x>:MARKer<y>:AOFF (No Query Form)

Turns off all the markers of all the traces in the specified view.

Syntax :CALCulate<x>:MARKer<y>:AOFF

Arguments None

Measurement Modes All

Examples :CALCulate1:MARKer1:AOFF
turns off all the markers of all the traces in View 1.

:CALCulate<x>:MARKer<y>:MAXimum (No Query Form)

Positions the marker at the maximum point on the trace in the specified view.

Syntax :CALCulate<x>:MARKer<y>:MAXimum

Arguments None

Measurement Modes All

Examples :CALCulate1:MARKer1:MAXimum
positions the marker at the maximum point on the trace in View 1.

:CALCulate<x>:MARKer<y>:MODE (?)

Selects or queries the marker mode (position or delta) in the specified view.

Syntax :CALCulate<x>:MARKer<y>:MODE { POSition | DELTa }
:CALCulate<x>:MARKer<y>:MODE?

Arguments POSition selects the position marker mode, in which the marker measurement is performed without the reference cursor. It works the same for both <y>=1 and 2.
DELTA selects the delta marker mode, in which the marker measurement is performed with the reference cursor. The reference cursor is placed at the position of the specified marker.

Measurement Modes All

Examples :CALCulate1:MARKer1:MODE DELTa
selects the delta marker mode in View 1.

:CALCulate<x>:MARKer<y>:PEAK:HIGHer (No Query Form)

Moves the marker higher in amplitude to the next peak in the specified view.

Syntax :CALCulate<x>:MARKer<y>:PEAK:HIGHer

Arguments None

Returns If no peak exists, the error message “No Peak Found Error (202)” is returned.

Measurement Modes All

Examples :CALCulate1:MARKer1:PEAK:HIGHer
moves Marker 1 higher in amplitude to the next peak in View 1.

:CALCulate<x>:MARKer<y>:PEAK:LEFT (No Query Form)

Shifts the marker to the next peak on the left in the specified view.

Syntax :CALCulate<x>:MARKer<y>:PEAK:LEFT

Arguments None

Returns If no peak exists, the error message “No Peak Found Error (202)” is returned.

Measurement Modes All

Examples :CALCulate1:MARKer1:PEAK:LEFT
shifts the marker to the next peak on the left in View 1.

:CALCulate<x>:MARKer<y>:PEAK:LOWer (No Query Form)

Moves the marker lower in amplitude to the next peak in the specified view.

Syntax :CALCulate<x>:MARKer<y>:PEAK:LOWer

Arguments None

Returns If no peak exists, error message “No Peak Found Error (202)” is returned.

Measurement Modes All

Examples :CALCulate1:MARKer1:PEAK:LOWer
moves Marker 1 lower in amplitude to the next peak in View 1.

:CALCulate<x>:MARKer<y>:PEAK:RIGHT (No Query Form)

Shifts the marker to the next peak on the right in the specified view.

Syntax :CALCulate<x>:MARKer<y>:PEAK:RIGHT

Arguments None

Returns If no peak exists, the error message “No Peak Found Error (202)” is returned.

Measurement Modes All

Examples :CALCulate1:MARKer1:PEAK:RIGHT
shifts the marker to the next peak on the right in View 1.

:CALCulate<x>:MARKer<y>:PTHReshold (?)

Sets or queries the horizontal minimum jump of the marker for peak search in the specified view.

Syntax :CALCulate<x>:MARKer<y>:PTHReshold <value>
:CALCulate<x>:MARKer<y>:PTHReshold?

Arguments <value>::=<NRf> sets the minimum jump of the marker for peak search.
Range: 1% to 20% of the span setting.

Measurement Modes All

Examples :CALCulate1:MARKer1:PTHReshold 10kHz
sets the minimum jump of Marker 1 to 10 kHz for peak search.

:CALCulate<x>:MARKer<y>:ROFF (No Query Form)

Turns off the reference cursor in the specified view.

Syntax :CALCulate<x>:MARKer<y>:ROFF

Arguments None

Measurement Modes All

Examples :CALCulate1:MARKer1:ROFF
turns off the reference cursor in View 1.

Related Commands :CALCulate<x>:MARKer<y>[:SET]:RCURsor

:CALCulate<x>:MARKer<y>[:SET]:CENTER (No Query Form)

Sets the center frequency to the value at the marker position in the specified view.

Syntax :CALCulate<x>:MARKer<y>[:SET]:CENTER

Arguments None

Measurement Modes SANORMAL, SASGRAM, SARTIME

Examples :CALCulate1:MARKer1:SET:CENTer
sets the center frequency to the value at the marker position in View 1.

:CALCulate<x>:MARKer<y>[:SET]:MEASurement (No Query Form)

Defines the measurement position using the marker(s) in the specified view.

NOTE. This command is available in a view that represents time along the horizontal axis.

The function varies between the marker modes as follows:

- *For the position marker mode:*
Sets the current position of the specified marker to the measurement start position.
- *For the delta marker mode:*
Sets the current positions of the specified marker and the reference cursor to the measurement start and stop positions.

The marker mode is selected with the :CALCulate<x>:MARKer<y>:MODE command (refer to page 2–51).

Syntax :CALCulate<x>:MARKer<y>[:SET]:MEASurement

Arguments None

Measurement Modes DEMADEM, DEMDDEM, TIMCCDF, TIMTRAN

Examples :CALCulate1:MARKer1:SET:MEASurement
defines the measurement position using the marker in View 1.

Related Commands :CALCulate<x>:MARKer<y>:MODE

:CALCulate<x>:MARKer<y>[:SET]:RCURsor (No Query Form)

Displays the reference cursor at the marker position in the specified view.

Syntax :CALCulate<x>:MARKer<y>[:SET]:RCURsor

Arguments None

Measurement Modes All

Examples :CALCulate1:MARKer1:SET:RCURsor
displays the reference cursor in View 1.

Related Commands :CALCulate<x>:MARKer<y>:ROFF

:CALCulate<x>:MARKer<y>[:STATe] (?)

Determines whether to turn on or off the marker(s) in the specified view.

Syntax :CALCulate<x>:MARKer<y>[:STATe] { OFF | ON | 0 | 1 }
:CALCulate<x>:MARKer<y>[:STATe]?

Arguments OFF or 0 hides the marker(s). If you have selected the delta marker mode, both the main and delta markers will be turned off.

ON or 1 shows the marker(s). If you have selected the delta marker mode, both the main and delta markers will be turned on.

To select a marker mode, use :CALCulate<x>:MARKer<y>:MODE.

Measurement Modes All

Examples :CALCulate1:MARKer1:STATe ON
enables Marker 1 in View 1.

Related Commands :CALCulate<x>:MARKer<y>:MODE

:CALCulate<x>:MARKer<y>:T (?)*Option 21 Only*

Sets or queries the time position of the marker in the specified view.

NOTE. *This command is valid in the eye diagram and the constellation view.*

Syntax :CALCulate<x>:MARKer<y>:T <time>
:CALCulate<x>:MARKer<y>:T?**Arguments** <time>::=<NRf> sets the time position of the marker in seconds.
For the setting range, refer to Table D-1 in *Appendix D*.**Measurement Modes** DEMDDEM**Examples** :CALCulate4:MARKer1:T -1.5ms
places Marker 1 at -1.5 ms in View 4 of the eye diagram.**:CALCulate<x>:MARKer<y>:TOGGLE (No Query Form)**

Replaces the marker and the reference cursor with each other in the specified view.

Syntax :CALCulate<x>:MARKer<y>:TOGGLE**Arguments** None**Measurement Modes** All**Examples** :CALCulate1:MARKer1:TOGGLE
replaces Marker 1 and the reference cursor with each other in View 1.

:CALCulate<x>:MARKer<y>:TRACe (?)

Selects the trace to place the marker in the specified view.

The query command returns the name of the trace on which the marker is currently placed.

Syntax :CALCulate<x>:MARKer<y>:TRACe { MAIN | SUB }

:CALCulate<x>:MARKer<y>:TRACe?

Arguments MAIN places the specified marker on Trace 1 (displayed in yellow on screen).

SUB places the specified marker on Trace 2 (displayed in green on screen).

Measurement Modes All

Examples :CALCulate1:MARKer1:TRACe SUB
places Marker 1 on Trace 2 in View 1.

:CALCulate<x>:MARKer<y>:X (?)

Sets or queries the horizontal position of the marker in the specified view.

NOTE. For the eye diagram or the constellation view, only query is available. For the constellation view, the returned value means an amplitude.

Syntax :CALCulate<x>:MARKer<y>:X <param>
:CALCulate<x>:MARKer<y>:X?

Arguments <param>::=<NRf> specifies the horizontal marker position.

The parameter value is different between the marker modes as follows:

- *For the position marker mode:*
Sets the absolute position of the specified marker.
- *For the delta marker mode:*
Sets the relative position of the specified marker from the reference cursor.

The marker mode is selected with the :CALCulate<x>:MARKer<y>:MODE command (refer to page 2–51).

The valid setting range depends on the display format. Refer to Table D–1 in *Appendix D*.

Measurement Modes All

Examples :CALCulate1:MARKer1:X 800MHz
places Marker 1 at 800 MHz in View 1 when the horizontal axis represents frequency.

Related Commands :CALCulate<x>:MARKer<y>:MODE

:CALCulate<x>:MARKer<y>:Y (?)

Sets or queries the vertical position of the marker in the specified view.

NOTE. The setting command is valid in the spectrogram view displayed in the Real Time S/A (real-time spectrum analysis) mode and in the overview of the Demod (modulation analysis) and the Time (time analysis) modes. If the command is executed in other views, the error message “Execution Error” (–200) is returned.

The query is available in all views. For the constellation view, the returned value means a phase.

Syntax :CALCulate<x>:MARKer<y>:Y <param>
:CALCulate<x>:MARKer<y>:Y?

Arguments <param>::=<NRf> specifies the vertical marker position.

The parameter value is different between the marker modes as follows:

- *For the position marker mode:*
Sets the absolute position of the specified marker.
- *For the delta marker mode:*
Sets the relative position of the specified marker from the reference cursor.

The marker mode is selected with the :CALCulate<x>:MARKer<y>:MODE command (refer to page 2–51).

For the setting range, refer to Table D–1 in *Appendix D*.

Measurement Modes SARTIME, DEMADEM, DEMDDEM, TIMCCDF, and TIMTRAN for setting.
All modes for query.

Examples :CALCulate1:MARKer1:Y –20
places the first marker at frame #–20 in View 1 (spectrogram).

:CALCulate2:MARKer1:Y?
might return –34.28 indicating the first marker readout is –34.28 dBm in View 2 (spectrum).

Related Commands :CALCulate<x>:MARKer<y>:MODE

:CALCulate<x>:VLINe<y> (?)

Sets or queries the horizontal position of the vertical line.

Syntax :CALCulate<x>:VLINe<y> <value>
:CALCulate<x>:VLINe<y>?

Arguments <value>::=<NRf> specifies the horizontal position of the vertical line.
Range: 0 Hz to 3 GHz for RSA3303A, or 8 GHz for RSA3308A.

Measurement Modes SANORMAL, SASGRAM, SARTIME

Examples :CALCulate1:VLINe1 800MHz
sets the horizontal position of Vertical Line 1 to 800 MHz.

Related Commands :CALCulate<x>:VLINe<y>:STATe

:CALCulate<x>:VLINe<y>:STATe (?)

Determines whether to turn on or off the vertical line.

Syntax :CALCulate<x>:VLINe<y>:STATe { OFF | ON | 0 | 1 }
:CALCulate<x>:VLINe<y>:STATe?

Arguments OFF or 0 hides the vertical line.
ON or 1 shows the vertical line.

Measurement Modes SANORMAL, SASGRAM, SARTIME

Examples :CALCulate1:VLINe1:STATe ON
shows Vertical Line 1 in View 1.

:CALibration Commands

The :CALibration commands run calibrations on the analyzer.
For details on calibrations, refer to the *RSA3303A and RSA3308A User Manual*.

Command Tree

Header	Parameter
:CALibration	
[:ALL]	
:AUTO	
:DATA	
:DEFault	
:OFFSet	
:BASEbanddc	
:CENTer	
:IQINput (Option 03 only)	
:RF	

:CALibration[:ALL] (?)

Runs the following three calibrations:

- RF gain calibration
- Center offset calibration
- DC offset calibration (if the measurement frequency band is the baseband)

The :CALibration[:ALL]? query command runs these calibrations and returns the results. This command is equivalent to the *CAL? query command.

Syntax :CALibration[:ALL]
:CALibration[:ALL]?

Arguments None

Returns <NR1>
0 indicates a normal end. For details of the error codes, refer to page 3–17.

Measurement Modes All

Examples :CALibration:ALL
runs all calibrations.

Related Commands *CAL?

:CALibration:AUTO (?)

Determines whether to run the RF gain calibration automatically.

Syntax :CALibration:AUTO { OFF | ON | 0 | 1 }
:CALibration:AUTO?

Arguments OFF or 0 specifies that the analyzer does not run the RF gain calibration automatically. Use the :CALibration:RF command to run the RF gain calibration.

ON or 1 specifies that the analyzer runs the RF gain calibration automatically.

Measurement Modes All

Examples :CALibration:AUTO ON
specifies that the analyzer runs the RF gain calibration automatically.

Related Commands :CALibration:RF

:CALibration:DATA:DEFault (No Query Form)

Restores the calibration data to the factory defaults.

Syntax :CALibration:DATA:DEFault

Arguments None

Measurement Modes All

Examples :CALibration:DATA:DEFault
restores the calibration data to the factory defaults.

:CALibration:OFFSet:BASEbanddc (?)

Runs the baseband DC offset calibration. The query version of this command runs the calibration and, if it ends normally, returns 0.

NOTE. This command is available when the analyzer operates in the baseband (DC to 20 MHz). The frequency setting must satisfy the following condition: $(\text{center frequency}) + (\text{span})/2 \leq 17.5 \text{ MHz}$

Syntax :CALibration:OFFSet:BASEbanddc
:CALibration:OFFSet:BASEbanddc?

Arguments None

Returns <NR1>
0 indicates a normal end. For details of the error codes, refer to page 3–17.

Measurement Modes All

Examples :CALibration:OFFSet:BASEbanddc
runs the baseband DC offset calibration.

:CALibration:OFFSet:CENTer (?)

Runs the center offset calibration. The query version of this command runs the calibration and, if it ends normally, returns 0.

Syntax :CALibration:OFFSet:CENTer
:CALibration:OFFSet:CENTer?

Arguments None

Returns <NR1>
0 indicates a normal end. For details of the error codes, refer to page 3–17.

Measurement Modes All

Examples :CALibration:OFFSet:CENTer
runs the center offset calibration.

:CALibration:OFFSet:IQINput (?)

Option 03 Only

Runs the IQ input offset calibration. The query version of this command runs the calibration, and if it ends normally, returns 0.

NOTE. Before running the IQ input offset calibration, connect the I/Q signal to the I/Q input connector on the rear panel and set the I/Q signal level to 0.

To run this command, you must have selected IQ in the [:SENSe]:FEED command.

Syntax :CALibration:OFFSet:IQINput
:CALibration:OFFSet:IQINput?

Arguments None

Returns <NR1>
0 indicates a normal end. For details of the error codes, refer to page 3–17.

Measurement Modes All

Examples :CALibration:OFFSet:IQINput
runs the IQ input offset calibration.

Related Commands [:SENSe]:FEED

:CALibration:RF (?)

Runs the RF gain calibration. The query version of this command runs the calibration and, if it ends normally, returns 0.

Syntax :CALibration:RF
:CALibration:RF?

Arguments None

Returns <NR1>
0 indicates a normal end. For details of the error codes, refer to page 3–17.

Measurement Modes All

Examples :CALibration:RF
runs the RF gain calibration.

Related Commands :CALibration:AUTO

:CONFigure Commands

The :CONFigure commands set up the analyzer to the default settings for the specified measurement.

Command Tree

Header	Parameter
:CONFigure	
:ADEMod	
:AM	
:FM	
:PM	
:CCDF	
:DDEMod (Option 21 only)	
:OVIew	
:PULSe	
:SPECTrum	
:ACPower	
:CFRequency	
:CHPower	
:CNRatio	
:EBWidth	
:OBWidth	
:SPURious	
:TFRequency	
:RTIME	
:SGRam	
:TRANsient	
:FVTime	
:IQVTime	
:PVTTime	

NOTE. Data acquisition stops on completion of a :CONFigure command. The following each command description shows the front-panel key operation equivalent to running the command except data acquisition control.

:CONFigure:ADEMod:AM (No Query Form)

Sets up the analyzer to the default settings for AM signal analysis.
Running this command is equivalent to pressing the following front panel keys:

DEMODO key → **Analog Demod** side key → **PRESET** key
→ **AM Demod** side key

Syntax :CONFigure:ADEMod:AM

Arguments None

Measurement Modes DEMADEM

Examples :CONFigure:ADEMod:AM
sets up the analyzer to the default settings for AM signal analysis.

Related Commands :INSTRument[:SElect]

:CONFigure:ADEMod:FM (No Query Form)

Sets up the analyzer to the default settings for FM signal analysis.
Running this command is equivalent to pressing the following front panel keys:

DEMODO key → **Analog Demod** side key → **PRESET** key
→ **FM Demod** side key

Syntax :CONFigure:ADEMod:FM

Arguments None

Measurement Modes DEMADEM

Examples :CONFigure:ADEMod:FM
sets up the analyzer to the default settings for FM signal analysis.

Related Commands :INSTRument[:SElect]

:CONFigure:ADEMod:PM (No Query Form)

Sets up the analyzer to the default settings for PM signal analysis.
Running this command is equivalent to pressing the following front panel keys:

DEM key → **Analog Demod** side key → **PRESET** key
→ **PM Demod** side key

Syntax	:CONFigure:ADEMod:PM
Arguments	None
Measurement Modes	DEMADEM
Examples	:CONFigure:ADEMod:PM sets up the analyzer to the default settings for PM signal analysis.
Related Commands	:INSTrument[:SElect]

:CONFigure:CCDF (No Query Form)

Sets up the analyzer to the default settings for CCDF measurement.
Running this command is equivalent to pressing the following front panel keys:

TIME key → **CCDF** side key → **PRESET** key → **CCDF** side key

Syntax	:CONFigure:CCDF
Arguments	None
Measurement Modes	TIMCCDF
Examples	:CONFigure:CCDF sets up the analyzer to the default settings for CCDF measurement.
Related Commands	:INSTrument[:SElect]

:CONFigure:DDEMod (No Query Form)

Option 21 Only

Sets up the analyzer to the default settings for digital modulation analysis. Running this command is equivalent to pressing the following front panel keys:

DEMOD key → **Digital Demod** side key → **PRESET** key
→ **IQ/Frequency versus Time** side key

Syntax :CONFigure:DDEMod

Arguments None

Measurement Modes DEMDDEM

Examples :CONFigure:DDEMod
sets up the analyzer to the default settings for digital modulation analysis.

Related Commands :INSTrument[:SElect]

:CONFigure:OVlew (No Query Form)

Turns the measurement off in the Demod (modulation analysis) and the Time (time analysis) modes to obtain data in the overview with the :FETCh:OVlew? or the :READ:OVlew? command. Running this command is equivalent to pressing the following front panel keys:

MEASURE key → **Measurement Off** side key

Syntax :CONFigure:OVlew

Arguments None

Measurement Modes DEMADEM, TIMCCDF, TIMTRAN

Examples :CONFigure:OVlew
turns the measurement off in the Demod and the Time modes.

Related Commands :FETCh:OVlew?, :READ:OVlew?, :INSTrument[:SElect]

:CONFigure:PULSe (No Query Form)

Sets the analyzer to the default settings for pulse characteristics measurement.

TIME key → **Pulse Measurements** side key → **PRESET** key

Syntax :CONFigure:PULSe

Arguments None

Measurement Modes TIMPULSE

Examples :CONFigure:PULSe
sets the analyzer to the default settings for pulse characteristics measurement.

Related Commands :INSTrument[:SElect]

:CONFigure:SPECTrum (No Query Form)

Sets up the analyzer to the default settings for spectrum measurement.

Running this command is equivalent to pressing the following front panel keys:

S/A key → { **Spectrum Analyzer** | **S/A with Spectrogram** | **Real Time S/A** }
side key → **PRESET** key → **Measurement Off** side key

Syntax :CONFigure:SPECTrum

Arguments None

Measurement Modes SANORMAL, SASGRAM, SARTIME

Examples :CONFigure:SPECTrum
sets up the analyzer to the default settings for spectrum measurement.,

Related Commands :INSTrument[:SElect]

:CONFigure:SPECTrum:ACPower (No Query Form)

Sets up the analyzer to the default settings for adjacent channel leakage power ratio (ACPR) measurement. Running this command is equivalent to pressing the following front panel keys:

S/A key → { **Spectrum Analyzer** | **S/A with Spectrogram** | **Real Time S/A** }
side key → **PRESET** key → **ACPR** side key

Syntax :CONFigure:SPECTrum:ACPower

Arguments None

Measurement Modes SANORMAL, SASGRAM, SARTIME

Examples :CONFigure:SPECTrum:ACPower
sets up the analyzer to the default settings for ACPR measurement.

Related Commands :INSTrument[:SElect]

:CONFigure:SPECTrum:CFRequency (No Query Form)

Sets up the analyzer to the default settings for carrier frequency measurement. Running this command is equivalent to pressing the following front panel keys:

S/A key → { **Spectrum Analyzer** | **S/A with Spectrogram** | **Real Time S/A** }
side key → **PRESET** key → **Carrier Frequency** side key

Syntax :CONFigure:SPECTrum:CFRequency

Arguments None

Measurement Modes SANORMAL, SASGRAM, SARTIME

Examples :CONFigure:SPECTrum:CFRequency
sets up the analyzer to the default settings for carrier frequency measurement.

Related Commands :INSTrument[:SElect]

:CONFigure:SPECTrum:CHPower (No Query Form)

Sets up the analyzer to the default settings for channel power measurement. Running this command is equivalent to pressing the following front panel keys:

S/A key → { **Spectrum Analyzer** | **S/A with Spectrogram** | **Real Time S/A** }
side key → **PRESET** key → **Channel Power** side key

Syntax :CONFigure:SPECTrum:CHPower

Arguments None

Measurement Modes SANORMAL, SASGRAM, SARTIME

Examples :CONFigure:SPECTrum:CHPower
sets up the analyzer to the default settings for channel power measurement.

Related Commands :INSTrument[:SElect]

:CONFigure:SPECTrum:CNRatio (No Query Form)

Sets up the analyzer to the default settings for carrier-to-noise ratio (C/N) measurement. Running this command is equivalent to pressing the following front panel keys:

S/A key → { **Spectrum Analyzer** | **S/A with Spectrogram** | **Real Time S/A** }
side key → **PRESET** key → **C/N** side key

Syntax :CONFigure:SPECTrum:CNRatio

Arguments None

Measurement Modes SANORMAL, SASGRAM, SARTIME

Examples :CONFigure:SPECTrum:CNRatio
sets up the analyzer to the default settings for C/N measurement.

Related Commands :INSTrument[:SElect]

:CONFigure:SPECTrum:EBWidth (No Query Form)

Sets up the analyzer to the default settings for emission bandwidth (EBW) measurement. Running this command is equivalent to pressing the following front panel keys:

S/A key → { **Spectrum Analyzer** | **S/A with Spectrogram** | **Real Time S/A** }
side key → **PRESET** key → **EBW** side key

Syntax :CONFigure:SPECTrum:EBWidth

Arguments None

Measurement Modes SANORMAL, SASGRAM, SARTIME

Examples :CONFigure:SPECTrum:EBWidth
sets up the analyzer to the default settings for EBW measurement.

Related Commands :INSTRument[:SElect]

:CONFigure:SPECTrum:OBWidth (No Query Form)

Sets up the analyzer to the default settings for occupied bandwidth (OBW) measurement. Running this command is equivalent to pressing the following front panel keys:

S/A key → { **Spectrum Analyzer** | **S/A with Spectrogram** | **Real Time S/A** }
side key → **PRESET** key → **OBW** side key

Syntax :CONFigure:SPECTrum:OBWidth

Arguments None

Measurement Modes SANORMAL, SASGRAM, SARTIME

Examples :CONFigure:SPECTrum:OBWidth
sets up the analyzer to the default settings for OBW measurement:

Related Commands :INSTRument[:SElect]

:CONFigure:SPECTrum:SPURious (No Query Form)

The following example sets up the analyzer to the default settings for spurious emission measurement. Running this command is equivalent to pressing the following front panel keys:

S/A key → { **Spectrum Analyzer** | **S/A with Spectrogram** | **Real Time S/A** }
side key → **PRESET** key → **Spurious** side key

Syntax	:CONFigure:SPECTrum:SPURious
Arguments	None
Measurement Modes	SANORMAL, SASGRAM, SARTIME
Examples	:CONFigure:SPECTrum:SPURious sets up the analyzer to the default settings for spurious signal measurement.
Related Commands	:INSTrument[:SElect]

:CONFigure:TFRequency:RTIME (No Query Form)

Sets up the analyzer to the default settings for the real-time spectrum measurement. Running this command is equivalent to pressing the following front panel keys:

S/A key → **Real Time S/A** side key → **PRESET** key

Syntax	:CONFigure:TFRequency:RTIME
Arguments	None
Measurement Modes	SARTIME
Examples	:CONFigure:TFRequency:RTIME sets up the analyzer to the default settings for the real-time spectrum measurement.
Related Commands	:INSTrument[:SElect]

:CONFigure:TFRequency:SGRam (No Query Form)

Sets up the analyzer to the default settings for the spectrogram measurement.
Running this command is equivalent to pressing the following front panel keys:

S/A key → **S/A with Spectrogram** side key → **PRESET** key

Syntax :CONFigure:TFRequency:SGRam

Arguments None

Measurement Modes SASGRAM

Examples :CONFigure:TFRequency:SGRam
sets up the analyzer to the default settings for the spectrogram measurement.

Related Commands :INSTRument[:SElect]

:CONFigure:TRANSient:FVTime (No Query Form)

Sets up the analyzer to the default settings for frequency vs. time measurement.
Running this command is equivalent to pressing the following front panel keys:

TIME key → **Transient** side key → **PRESET** key
→ **Frequency versus Time** side key

Syntax :CONFigure:TRANSient:FVTime

Arguments None

Measurement Modes TIMTRAN

Examples :CONFigure:TRANSient:FVTime
sets up the analyzer to the default settings for frequency vs. time measurement.

Related Commands :INSTRument[:SElect]

:CONFigure:TRANsient:IQVTime (No Query Form)

Sets up the analyzer to the default settings for IQ level vs. time measurement. Running this command is equivalent to pressing the following front panel keys:

TIME key → **Transient** side key → **PRESET** key → **IQ versus Time** side key

Syntax :CONFigure:TRANsient:IQVTime

Arguments None

Measurement Modes TIMTRAN

Examples :CONFigure:TRANsient:IQVTime
sets up the analyzer to the default settings for IQ level vs. time measurement.

Related Commands :INSTrument[:SElect]

:CONFigure:TRANsient:PVTime (No Query Form)

Sets up the analyzer to the default settings for power vs. time measurement. Running this command is equivalent to pressing the following front panel keys:

S/A key → **Transient** side key → **PRESET** key
→ **Power versus Time** side key

Syntax :CONFigure:TRANsient:PVTime

Arguments None

Measurement Modes TIMTRAN

Examples :CONFigure:TRANsient:PVTime
sets up the analyzer to the default settings for power vs. time measurement.

Related Commands :INSTrument[:SElect]

:DISPlay Commands

The :DISPlay commands control how to show measurement data on the screen. These commands are divided into the following subgroups:

Table 2-30: :DISPlay command subgroups

Command header	Function	Refer to:
:DISPlay:CCDF	Control display of the CCDF analysis.	page 2-86
:DISPlay:DDEMod (Option 21 only)	Control display of the digital modulation analysis.	page 2-92
:DISPlay:OVlew	Control the Demod and Time mode overview.	page 2-121
:DISPlay:PULSe:MVlew :SVlew	Control the main/sub view in the pulse characteristics analysis.	page 2-130
:DISPlay:PULSe:SPECtrum	Control the spectrum view in the pulse characteristics analysis.	page 2-140
:DISPlay:PULSe:WAVEform	Control the time domain view in the pulse characteristics analysis.	page 2-145
:DISPlay:SPECtrum	Control the spectrum view.	page 2-149
:DISPlay:TFRrequency	Control the three-dimensional (spectrogram) view.	page 2-159
:DISPlay[:VIEW]	Set the display brightness and format.	page 2-168
:DISPlay:WAVEform	Control time domain view.	page 2-171

NOTE. The :DISPlay commands change the measurement display only, and do not affect the analyzer hardware settings.

Note on Horizontal Scaling

You can expand an acquired waveform vertically and horizontally on screen (but not contract). Use the :DISPlay commands containing :X[:SCALe] or :Y[:SCALe] node to set the expansion range. Refer to each command description for the setting range. Additionally, meet the following requirements for setting the horizontal scale.

The horizontal display range set by the :DISPlay commands must be within the data acquisition range set by the :SENSe commands (see Figure 2–6):

$$\begin{aligned} X_{START} &\leq X_{MIN} < X_{STOP} \\ X_{MAX} &\leq X_{STOP} \end{aligned}$$

Where

- X_{START} : the beginning of data acquisition range
- X_{STOP} : the end of data acquisition range
- X_{MIN} : the beginning of data expansion range
- X_{MAX} : the end of data expansion range

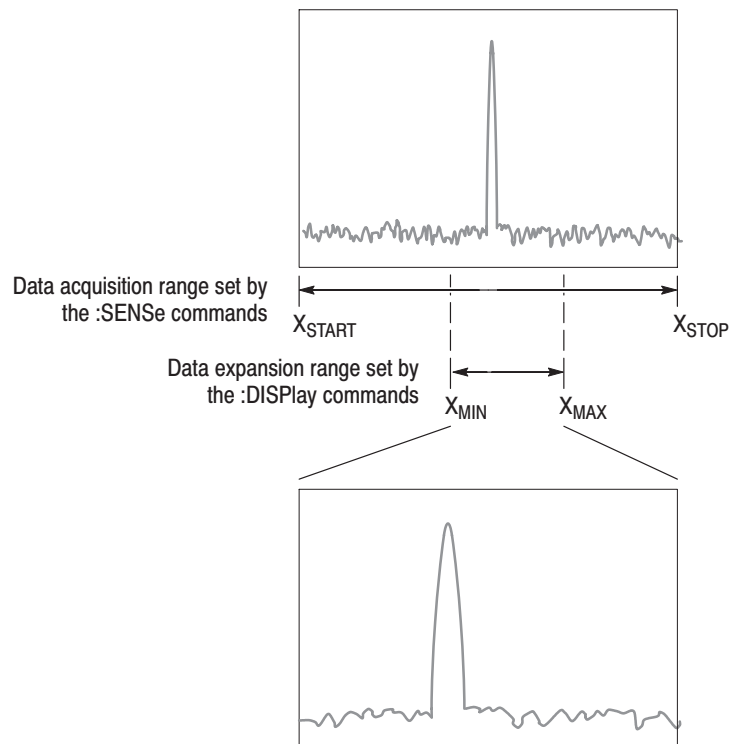

Figure 2-6: Horizontal scale setting requirements

The :DISPlay commands containing the :X[:SCALE] node must meet the above requirements. Figure 2–7 shows an example of the spectrum view. The horizontal scale setting requirements are:

$$\begin{aligned} \text{CENTer} - \text{SPAN}/2 &\leq \text{OFFSet} < \text{CENTer} + \text{SPAN}/2 \\ \text{OFFSet} + 10 * \text{PDIV} &\leq \text{CENTer} + \text{SPAN}/2 \end{aligned}$$

Where

CENTer: [:SENSe]:FREQuency:CENTer value

SPAN: [:SENSe]:FREQuency:SPAN value

OFFSet: :DISPlay:SPECTrum:X[:SCALE]:OFFSet value

PDIVision: :DISPlay:SPECTrum:X[:SCALE]:PDIVision value

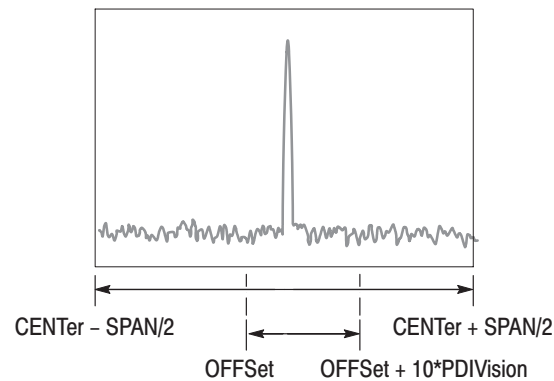

Figure 2–7: Horizontal scale setting requirements for spectrum view

:DISPlay:CCDF Subgroup

The :DISPlay:CCDF commands control the CCDF view.

NOTE. To use a command of this group, you must have selected TIMCCDF in the :INSTrument[:SELEct] command.

Command Tree	Header	Parameter
	:DISPlay	
	:CCDF	
	:LINE	
	:GAUSSian	
	[:STATE]	<boolean>
	:REFERence	
	[:STATE]	<boolean>
	:STORE	
	:X	
	[:SCALE]	
	:AUTO	<boolean>
	:MAXimum	<relative_amplitude>
	:OFFSet	<relative_amplitude>
	:Y	
	[:SCALE]	
	:FIT	
	:FULL	
	:MAXimum	<percent>
	:MINimum	<percent>

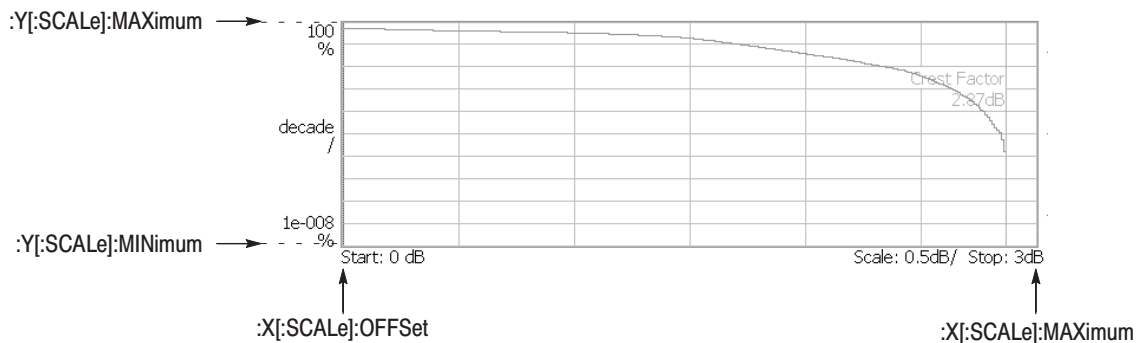

NOTE: Command header :DISPlay:CCDF is omitted here.

Figure 2-8: :DISPlay:CCDF command setting

:DISPlay:CCDF:LINE:GAUSSian[:STATe](?)

Determines whether to show the Gaussian line in the CCDF view.

Syntax :DISPlay:CCDF:LINE:GAUSSian[:STATe] { OFF | ON | 0 | 1 }
:DISPlay:CCDF:LINE:GAUSSian[:STATe]?

Arguments OFF or 0 hides the Gaussian line.
ON or 1 shows the Gaussian line in the CCDF view.

Measurement Modes TIMCCDF

Examples :DISPlay:CCDF:LINE:GAUSSian:STATe ON
shows the Gaussian line in the CCDF view.

:DISPlay:CCDF:LINE:REFerence[:STATe](?)

Selects whether to show the reference line in the CCDF view. The reference line is stored with the :DISPlay:CCDF:LINE:REFerence:STORe command.

Syntax :DISPlay:CCDF:LINE:REFerence[:STATe] { OFF | ON | 0 | 1 }
:DISPlay:CCDF:LINE:REFerence[:STATe]?

Arguments OFF or 0 hides the reference line.
ON or 1 shows the reference line in the CCDF view.

Measurement Modes TIMCCDF

Examples :DISPlay:CCDF:LINE:REFerence:STATe ON
shows the reference line in the CCDF view.

Related Commands :DISPlay:CCDF:LINE:REFerence:STORe

:DISPlay:CCDF:LINE:REFerence:STORe (No Query Form)

Stores the current CCDF trace as a new reference line and automatically enables the reference line display.

Syntax :DISPlay:CCDF:LINE:REFerence:STORe

Arguments None

Measurement Modes TIMCCDF

Examples :DISPlay:CCDF:LINE:REFerence:STORe
stores the current CCDF trace as a new reference line.

Related Commands :DISPlay:CCDF:LINE:REFerence[:STATe]

:DISPlay:CCDF:X[:SCALe]:AUTO(?)

Determines whether to automatically set the horizontal, or power, scale in the CCDF view.

Syntax :DISPlay:CCDF:X[:SCALe]:AUTO { OFF | ON | 0 | 1 }
:DISPlay:CCDF:X[:SCALe]:AUTO?

Arguments OFF or 0 specifies that the horizontal scale is set manually (default). Use the :DISPlay:CCDF:X[:SCALe]:MAXimum and the :DISPlay:CCDF:X[:SCALe]:OFFSet commands, detailed below, to set the horizontal axis.

ON or 1 specifies that the horizontal scale is set automatically.

Measurement Modes TIMCCDF

Examples :DISPlay:CCDF:X:SCALe:AUTO ON
specifies that the horizontal scale is set automatically.

Related Commands :DISPlay:CCDF:X[:SCALe]:MAXimum, :DISPlay:CCDF:X[:SCALe]:OFFSet

:DISPlay:CCDF:X[:SCALe]:MAXimum(?)

Sets or queries the maximum horizontal, or power, value (right end) in the CCDF view.

Syntax :DISPlay:CCDF:X[:SCALe]:MAXimum <rel_amp1>
 :DISPlay:CCDF:X[:SCALe]:MAXimum?

Arguments <rel_amp1>::=<NRf> specifies the maximum horizontal value.
 Range: 0 to 15.01 dBm

Measurement Modes TIMCCDF

Examples :DISPlay:CCDF:X:SCALe:MAXimum 15
 sets the maximum horizontal value to 15 dBm.

Related Commands :DISPlay:CCDF:X[:SCALe]:AUTO

:DISPlay:CCDF:X[:SCALe]:OFFSet(?)

Sets or queries the start value of the horizontal axis in the CCDF view.

Syntax :DISPlay:CCDF:X[:SCALe]:OFFSet <rel_amp1>
 :DISPlay:CCDF:X[:SCALe]:OFFSet?

Arguments <rel_amp1>::=<NRf> specifies the start value of the horizontal axis.
 Range: 0 to 15.01 dBm

Measurement Modes TIMCCDF

Examples :DISPlay:CCDF:X:SCALe:OFFSet 5
 sets the start value of the horizontal axis to 5 dBm.

Related Commands :DISPlay:CCDF:X[:SCALe]:AUTO

:DISPlay:CCDF:Y[:SCALE]:FIT (No Query Form)

Runs auto-scale on the CCDF view. The auto-scale automatically sets the start value and scale of the vertical axis to display the whole waveform.

Syntax :DISPlay:CCDF:Y[:SCALE]:FIT

Arguments None

Measurement Modes TIMCCDF

Examples :DISPlay:CCDF:Y:SCALE:FIT
runs auto-scale on the CCDF view.

:DISPlay:CCDF:Y[:SCALE]:FULL (No Query Form)

Sets the vertical axis to the default full-scale value in the CCDF view.

Syntax :DISPlay:CCDF:Y[:SCALE]:FULL

Arguments None

Measurement Modes TIMCCDF

Examples :DISPlay:CCDF:Y:SCALE:FULL
sets the vertical axis to the default full-scale value in the CCDF view.

:DISPlay:CCDF:Y[:SCALe]:MAXimum(?)

Sets or queries the maximum vertical value (top end) in the CCDF view.

Syntax :DISPlay:CCDF:Y[:SCALe]:MAXimum <value>
:DISPlay:CCDF:Y[:SCALe]:MAXimum?

Arguments <value>::=<NRf> sets the maximum vertical value. Range: 10^{-9} to 100%.

Measurement Modes TIMCCDF

Examples :DISPlay:CCDF:Y:SCALe:MAXimum 80
sets the maximum vertical value to 80%.

:DISPlay:CCDF:Y[:SCALe]:MINimum(?)

Sets or queries the minimum vertical value (bottom end) in the CCDF view.

Syntax :DISPlay:CCDF:Y[:SCALe]:MINimum <value>
:DISPlay:CCDF:Y[:SCALe]:MINimum?

Arguments <value>::=<NRf> sets the minimum vertical value. Range: 10^{-9} to 100%.

Measurement Modes TIMCCDF

Examples :DISPlay:CCDF:Y:SCALe:MINimum 20
sets the minimum vertical value to 20%.

:DISPlay:DDEMod Subgroup (Option 21 Only)

The :DISPlay:DDEMod commands control display for the digital modulation analysis.

NOTE. To use a command from this group, you must have selected DEMDDEM (digital modulation analysis) in the :INSTRument[:SElect] command.

Command Tree	Header	Parameter
	:DISPlay	
	:DDEMod	
	:CCDF	
	:LINE	
	:GAUSSian	
	[:STATE]	<boolean>
	:MVIEW	
	:DSTART	AUTO FIX ADD
	:FORMAT	OFF IQVTime FVTime CONSTE VECTOR EVM MERROR PERROR IEYE QEYE TEYE STABLE PVTIME AMAM AMPM DAMAM DAMPM CCDF PDF
	:HSSHIFT	LEFT NONE RIGHT
	:RADIX	BINARY OCTAL HEXADecimal
	:X	
	[:SCALE]	
	:OFFSET	<numeric_value>
	:RANGE	<numeric_value>
	:Y	
	[:SCALE]	
	:FIT	
	:FULL	
	:MAXimum	<numeric_value>
	:MINimum	<numeric_value>
	:OFFSET	<numeric_value>
	:RANGE	<numeric_value>
	:NLINearity	
	:LINE	
	:BFIT	
	[:STATE]	<boolean>
	:REFERENCE	
	[:STATE]	<boolean>
	:MASK	
	[:STATE]	<boolean>

```

:SVIew
  :DStart      AUTO | FIX | ADD
  :FORMat      SPECTrum | IQVTime | FVTime
                | CONStE | VECTor | EVM
                | MERRor | PERRor
                | IEYE | QEYE | TEYE | STABle
                | PVTime | AMAM | AMPM
                | DAMam | DAMPm | CCDF | PDF
  :HSSHift     LEFT | NONE | RIGHT
  :RADix       BINary | OCTal | HEXadecimal
  :X
    [:SCALE]
      :OFFSet   <numeric_value>
      :RANGe    <numeric_value>
  :Y
    [:SCALE]
      :FIT
      :FULL
      :MAXimum  <numeric_value>
      :MINimum  <numeric_value>
      :OFFSet   <numeric_value>
      :RANGe    <numeric_value>

```

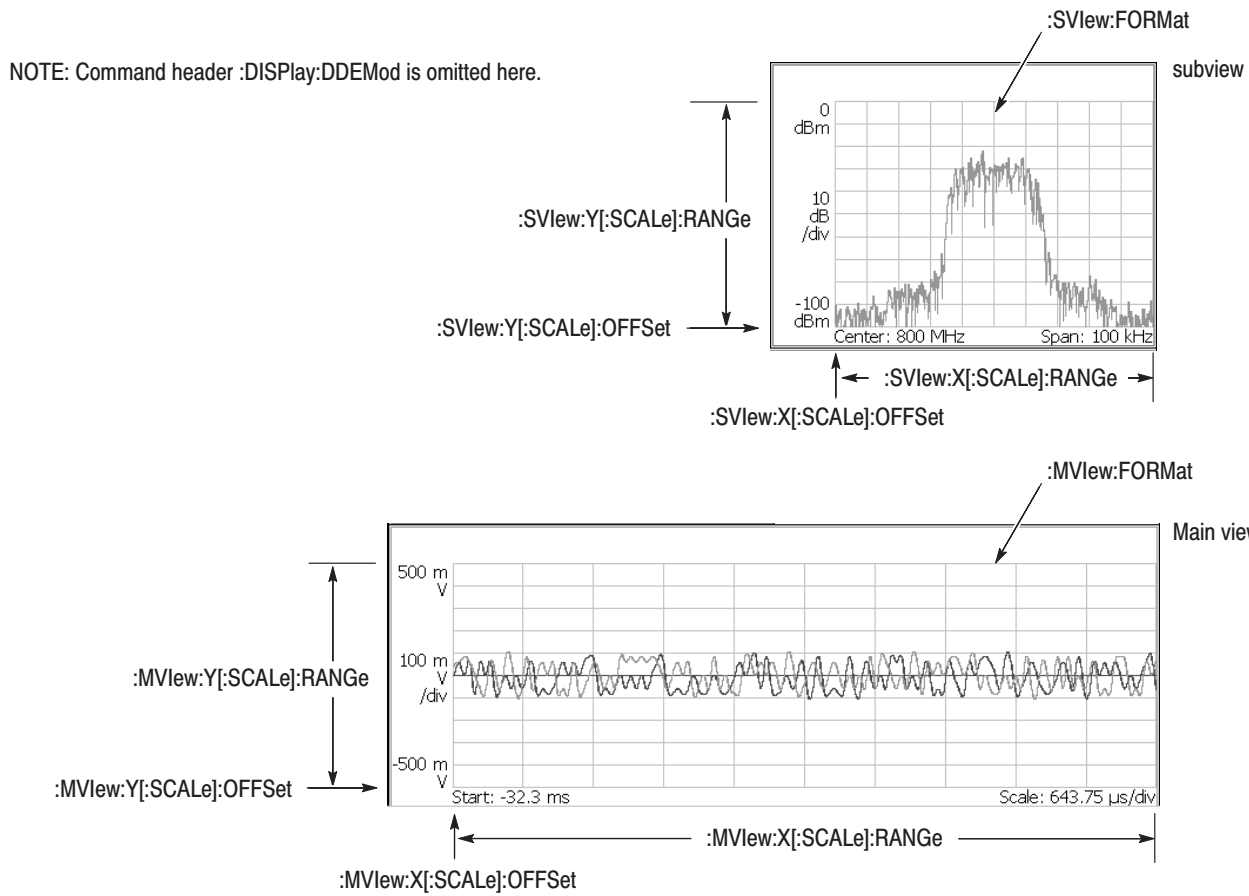

Figure 2-9: :DISPlay:DDEMod command setting

:DISPlay:DDEMod:CCDF:LINE:GAUSSian[:STATe](?)

Determines whether to display the Gaussian line for CCDF measurement in the digital modulation analysis. This command is valid only when :DISPlay:DDEMod:MVIew:FORMat is set to CCDF.

Syntax :DISPlay:DDEMod:CCDF:LINE:GAUSSian[:STATe]
{ ON | OFF | 1 | 0 }
:DISPlay:DDEMod:CCDF:LINE:GAUSSian[:STATe]?

Arguments ON or 1 shows the Gaussian line.
OFF or 0 hides the Gaussian line.

Measurement Modes DEMDDEM

Examples :DISPlay:DDEMod:CCDF:LINE:GAUSSian:STATe ON
displays the Gaussian line for the CCDF measurement.

Related Commands :DISPlay:DDEMod:MVIew:FORMat

:DISPlay:DDEMod:MVew:DStart(?)

Selects or queries the decoding start position for ASK, FSK, and GFSK signals with the decoding format of Manchester or Miller on the main view during the digital modulation analysis.

This command is valid when :DISPlay:DDEMod:MVew:FORMat is set to STABLE (symbol table), and [:SENSe]:DDEMod:FORMat is set to ASK, FSK, or GFSK.

Syntax :DISPlay:DDEMod:MVew:DStart { AUTO | FIX | ADD }
:DISPlay:DDEMod:MVew:DStart?

Arguments AUTO determines the decoding start position automatically.
FIX starts decoding from the beginning of a symbol.
ADD delays the decoding start position by half a symbol.

Measurement Modes DEMDDEM

Examples :DISPlay:DDEMod:MVew:DStart AUTO
determines the decoding start position automatically.

Related Commands :DISPlay:DDEMod:MVew:FORMat, [:SENSe]:DDEMod:FORMat

:DISPlay:DDEMod:MVew:FORMat(?)

Selects or queries the display format of the main view in the digital modulation analysis.

Syntax :DISPlay:DDEMod:MVew:FORMat { OFF | IQVTime | FVTime | CONStE
| VECTor | EVM | MERRor | PERRor | IEYE | QEYE | TEYE | STABLE
| PVTTime | AMAM | AMPM | DAMam | DAMPm | CCDF | PDF }
:DISPlay:DDEMod:MVew:FORMat?

Arguments The arguments and display formats are listed in Table 2–31:

Table 2-31: Main view display formats

Argument	Display format
OFF	Hides all measurement results
IQVTime	IQ level versus Time
FVTime	Frequency drift versus Time
CONSte	Constellation
VECTor	Vector
EVM	Error vector magnitude (EVM)
MERRor	Amplitude error
PERRor	Phase error
IEYE	Eye diagram (vertical axis: I data)
QEYE	Eye diagram (vertical axis: Q data)
TEYE	Eye diagram (vertical axis: Phase)
STABle	Symbol table
PVTime	Power versus Time
AMAM	AM/AM (vector)
AMPM	AM/PM (vector)
DAMam	AM/AM (dot)
DAMPm	AM/PM (dot)
CCDF	CCDF
PDF	PDF

NOTE. The argument *FVTime* is valid when [:SENSe]:DDEMod:FORMat is *GFSK* or *FSK*.

The argument *PVTime* is valid only when [:SENSe]:DDEMod:FORMat is *ASK*.

The display format is restricted by the modulation type. Refer to the *RSA3303A User Manual* for details.

Measurement Modes

DEMDDEM

Examples

:DISPlay:DDEMod:MVIew:FORMat IEYE
selects the eye diagram with I data along the vertical axis.

Related Commands

:DISPlay:DDEMod:SVIew:FORMat, [:SENSe]:DDEMod:FORMat

:DISPlay:DDEMod:MVlew:HSSHift(?)

Selects or queries the Q data half symbol shift for an OQPSK modulation signal on the main view during the digital modulation analysis.

NOTE. This command is valid when [:SENSe]:DDEMod:FORMat is set to OQPSK. This command setting affects the :DISPlay:DDEMod:SVIew:HSSHift command setting immediately.

Syntax :DISPlay:DDEMod:MVlew:HSSHift { LEFT | NONE | RIGHT }
:DISPlay:DDEMod:MVlew:HSSHift?

Arguments LEFT shifts Q data by half a symbol in the negative direction on the time axis.
NONE does not shift Q data (default).
RIGHT shifts Q data by half a symbol in the positive direction on the time axis.

Measurement Modes DEMDDEM

Examples :DISPlay:DDEMod:MVlew:HSSHift LEFT
shifts Q data by half a symbol in the negative direction on the time axis.

Related Commands :DISPlay:DDEMod:SVIew:HSSHift, [:SENSe]:DDEMod:FORMat

:DISPlay:DDEMod:MVlew:RADix(?)

Selects or queries the base of symbols in the main view in the digital modulation analysis.

This command is valid only when :DISPlay:DDEMod:MVlew:FORMat is set to STABLE (symbol table).

Syntax :DISPlay:DDEMod:MVlew:RADix { BINary | OCTal | HEXadecimal }
:DISPlay:DDEMod:MVlew:RADix?

Arguments BINary selects binary notation.
OCTal selects octal notation.
HEXadecimal selects hexadecimal notation.

Measurement Modes DEMDDEM

Examples :DISPlay:DDEMod:MVlew:RADix BINary
selects binary notation for the symbol table.

Related Commands :DISPlay:DDEMod:MVlew:FORMat

:DISPlay:DDEMod:MView:X[:SCALE]:OFFSet(?)

Sets or queries the minimum horizontal value (left edge) in the main view during the digital modulation analysis.

This command is not available when :DISPlay:DDEMod:MView:FORMat is set to CONSTe, VECTor, IEYE, QEYE, TEYE, or STABLE.

Syntax :DISPlay:DDEMod:MView:X[:SCALE]:OFFSet <value>
 :DISPlay:DDEMod:MView:X[:SCALE]:OFFSet?

Arguments <value>::=<NRf> specifies the minimum horizontal value in the main view. The valid range depends on the display format. Refer to Table D-1 in *Appendix D*.

Measurement Modes DEMDEM

Examples :DISPlay:DDEMod:MView:X:SCALE:OFFSet -40us
 sets the minimum horizontal value to $-40\ \mu\text{s}$ when the main view displays IQ level versus time.

Related Commands :DISPlay:DDEMod:MView:FORMat

:DISPlay:DDEMod:MView:X[:SCALE]:RANGe(?)

Sets or queries the full-scale value of the horizontal axis in the main view during the digital modulation analysis.

This command is not available when :DISPlay:DDEMod:MView:FORMat is set to CONSTe, VECTor, IEYE, QEYE, TEYE, STABLE, AMAM, AMPM, DAMam or DAMPm.

Syntax :DISPlay:DDEMod:MView:X[:SCALE]:RANGe <value>

:DISPlay:DDEMod:MView:X[:SCALE]:RANGe?

Arguments <value>::=<NRf> specifies the full-scale value of the horizontal axis in the main view. The valid range depends on the display format. Refer to Table D-1 in *Appendix D*.

Measurement Modes DEMDDEM

Examples :DISPlay:DDEMod:MView:X:SCALE:RANGe 40us
sets the full-scale value of the horizontal axis to 40 μ s when the main view displays IQ level versus time.

Related Commands :DISPlay:DDEMod:MView:FORMat

:DISPlay:DDEMod:MView:Y[:SCALE]:FIT (No Query Form)

Runs the auto-scale on the main view during the digital modulation analysis. The auto-scale automatically sets the start value and scale of the vertical axis to display the whole waveform.

This command is not available when :DISPlay:DDEMod:MView:FORMat is set to CONSTe, VECTor, IEYE, QEYE, TEYE, STABle, AMAM, AMPM, DAMam or DAMPm.

Syntax :DISPlay:DDEMod:MVIEw:Y[:SCALE]:FIT

Arguments None

Measurement Modes DEMDDEM

Examples :DISPlay:DDEMod:MVIEw:Y:SCALE:FIT
runs the auto-scale on the main view.

Related Commands :DISPlay:DDEMod:MVIEw:FORMat

:DISPlay:DDEMod:MView:Y[:SCALE]:FULL (No Query Form)

Sets the vertical axis in the main view to the default full-scale value during the digital modulation analysis.

This command is not available when :DISPlay:DDEMod:MView:FORMat is set to CONSTe, VECTor, IEYE, QEYE, TEYE, STABle, AMAM, AMPM, DAMam or DAMPm.

Syntax :DISPlay:DDEMod:MVIEw:Y[:SCALE]:FULL

Arguments None

Measurement Modes DEMDDEM

Examples :DISPlay:DDEMod:MVIEw:Y:SCALE:FULL
sets the main view's vertical axis to the default full-scale value.

Related Commands :DISPlay:DDEMod:MVIEw:FORMat

:DISPlay:DDEMod:MView:Y[:SCALe]:MAXimum(?)

Sets or queries the maximum vertical value (top end) in the CCDF main view during the digital modulation analysis.

This command is valid when :DISPlay:DDEMod:MView:FORMat is set to CCDF.

Syntax :DISPlay:DDEMod:MView:Y[:SCALe]:MAXimum <value>
:DISPlay:DDEMod:MView:Y[:SCALe]:MAXimum?

Arguments <value>::=<NRf> specifies the maximum vertical value in the CCDF view.
Range: Twice of the minimum value to 100%
The minimum value is set using the :DISPlay:DDEMod:MView:Y[:SCALe]:MINimum command.

Measurement Modes DEMDDEM

Examples :DISPlay:DDEMod:MView:Y:SCALe:MAXimum 80pct
sets the maximum vertical value to 80% in the CCDF main view.

Related Commands :DISPlay:DDEMod:MView:Y[:SCALe]:MINimum

:DISPlay:DDEMod:MVew:Y[:SCALe]:MINimum(?)

Sets or queries the minimum vertical value (bottom end) in the CCDF main view during the digital modulation analysis.

This command is valid when :DISPlay:DDEMod:MVew:FORMat is set to CCDF.

Syntax :DISPlay:DDEMod:MVew:Y[:SCALe]:MINimum <value>
 :DISPlay:DDEMod:MVew:Y[:SCALe]:MINimum?

Arguments <value> ::= <NRf> specifies the minimum vertical value in the CCDF view.
 Range: 0.01 to 1/2 of the maximum value in percent (%)

The maximum value is set using the :DISPlay:DDEMod:MVew:Y[:SCALe]:MAXimum command.

Measurement Modes DEMDEM

Examples :DISPlay:DDEMod:MVew:Y:SCALe:MINimum 0.1pct
 sets the minimum vertical value to 0.1% in the CCDF main view.

Related Commands :DISPlay:DDEMod:MVew:Y[:SCALe]:MAXimum

:DISPlay:DDEMod:MVIew:Y[:SCALe]:OFFSet(?)

Sets or queries the minimum vertical value (bottom) in the main view during the digital modulation analysis.

This command is not available when :DISPlay:DDEMod:MVIew:FORMat is set to CONSTe, VECTor, IEYE, QEYE, TEYE, STABLE, AMPM, DAMPM, or CCDF.

The query command is valid when :DISPlay:DDEMod:MVIew:FORMat is set to AMAM.

Syntax :DISPlay:DDEMod:MVIew:Y[:SCALe]:OFFSet <value>
:DISPlay:DDEMod:MVIew:Y[:SCALe]:OFFSet?

Arguments <value>::=<NRf> specifies the minimum vertical value in the main view. The valid range depends on the display format. Refer to Table D-1 in *Appendix D*.

Measurement Modes DEMDDEM

Examples :DISPlay:DDEMod:MVIew:Y:SCALe:OFFSet -500mV
sets the minimum vertical value to -500 mV when the main view displays IQ level versus time.

Related Commands :DISPlay:DDEMod:MVIew:FORMat

:DISPlay:DDEMod:MView:Y[:SCALE]:RANGe(?)

Sets or queries full-scale value of the vertical axis in the main view during the digital modulation analysis.

This command is not available when :DISPlay:DDEMod:MView:FORMat is set to CONSTe, VECTor, IEYE, QEYE, TEYE, STABLE, AMAM, DAMam, or CCDF.

Syntax :DISPlay:DDEMod:MView:Y[:SCALE]:RANGe <value>

:DISPlay:DDEMod:MView:Y[:SCALE]:RANGe?

Arguments <value> ::= <NRf> specifies full-scale value of the vertical axis in the main view. The valid range depends on the display format. Refer to Table D–1 in *Appendix D*.

Measurement Modes DEMDEM

Examples :DISPlay:DDEMod:MView:Y:SCALE:RANGe 500mV
sets full-scale value of the vertical axis to 500 mV when the the main view displays IQ level versus time.

Related Commands :DISPlay:DDEMod:MView:FORMat

:DISPlay:DDEMod:NLINearity:LINE:BFIT[:STATe](?)

Determines whether to display the best-fit line for the AM/AM or AM/PM measurement in the digital modulation analysis.

This command is valid only when :DISPlay:DDEMod:MVIew:FORMat is set to AMAM, AMPM, DAMam or DAMPm.

Syntax :DISPlay:DDEMod:NLINearity:LINE:BFIT[:STATe] { ON | OFF | 1 | 0 }
:DISPlay:DDEMod:NLINearity:LINE:BFIT[:STATe]?

Arguments ON or 1 shows the best-fit line.
OFF or 0 hides the best-fit line.

Measurement Modes DEMDDEM

Examples :DISPlay:DDEMod:NLINearity:LINE:BFIT:STATe ON
displays the best-fit line for AM/AM or AM/PM measurement.

Related Commands :DISPlay:DDEMod:MVIew:FORMat

:DISPlay:DDEMod:NLINearity:LINE:REFerence[:STATe](?)

Determines whether to display the recovered reference line for AM/AM or AM/PM measurement in the digital modulation analysis.

This command is valid only when :DISPlay:DDEMod:MVIew:FORMat is set to AMAM, AMPM, DAMam or DAMPm.

Syntax :DISPlay:DDEMod:NLINearity:LINE:REFerence[:STATe] { ON | OFF
| 1 | 0 }

:DISPlay:DDEMod:NLINearity:LINE:REFerence[:STATe]?

Arguments ON or 1 shows the reference line.

OFF or 0 hides the reference line.

Measurement Modes DEMDDEM

Examples :DISPlay:DDEMod:NLINearity:LINE:REFerence:STATe ON
displays the reference line for the AM/AM or AM/PM measurement.

Related Commands :DISPlay:DDEMod:MVIew:FORMat

:DISPlay:DDEMod:NLINearity:MASK[:STATe](?)

Determines whether the linear signal region is visible for the AM/AM measurement in the digital modulation analysis.

This command is valid only when :DISPlay:DDEMod:MVIew:FORMat is set to AMAM or DAMam.

Syntax :DISPlay:DDEMod:NLINearity:MASK[:STATe] { ON | OFF | 1 | 0 }
:DISPlay:DDEMod:NLINearity:MASK[:STATe]?

Arguments ON or 1 shows the linear signal region mask.
OFF or 0 hides the linear signal region mask.

Measurement Modes DEMDDEM

Examples :DISPlay:DDEMod:NLINearity:MASK:STATe ON
shows the linear signal region mask for the AM/AM measurement.

Related Commands :DISPlay:DDEMod:MVIew:FORMat

:DISPlay:DDEMod:SVIew:DStArt(?)

Selects or queries the decode start position for ASK, FSK, and GFSK modulation signals on the subview during the digital modulation analysis.

This command is valid when :DISPlay:DDEMod:SVIew:FORMat is set to STABLE (symbol table), and [:SENSE]:DDEMod:FORMat is set to ASK, FSK, or GFSK.

Syntax :DISPlay:DDEMod:SVIew:DStArt { AUTO | FIX | ADD }

:DISPlay:DDEMod:SVIew:DStArt?

Arguments AUTO searches for a possible pattern that matches the format.

FIX fixes the decode criterion inside.

ADD adds a half symbol delay before decoding.

Measurement Modes DEMDDEM

Examples :DISPlay:DDEMod:SVIew:DStArt AUTO
searches for a possible pattern that matches the format.

Related Commands :DISPlay:DDEMod:SVIew:FORMat, [:SENSE]:DDEMod:FORMat

:DISPlay:DDEMod:SVIew:FORMat(?)

Selects or queries the display format of the subview in the digital modulation analysis.

Syntax :DISPlay:DDEMod:SVIew:FORMat { SPECTrum | IQVTime | FVTime
| CONSTe | VECTor | EVM | MERRor | PERRor | IEYE | QEYE | TEYE
| STABLE | PVTTime | AMAM | AMPM | DAMam | DAMPm | CCDF | PDF }

:DISPlay:DDEMod:SVIew:FORMat?

Arguments The arguments and display formats are listed below:

Table 2-32: Subview display formats

Argument	Display format
SPECTrum	Spectrum
IQVTime	IQ level versus Time
FVTime	Frequency shift versus Time
CONSte	Constellation
VECTor	Vector
EVM	Error vector magnitude (EVM)
MERRor	Amplitude error
PERRor	Phase error
IEYE	Eye diagram (vertical axis: I data)
QEYE	Eye diagram (vertical axis: Q data)
TEYE	Eye diagram (vertical axis: Phase)
STABle	Symbol table
PVTime	Power versus Time
AMAM	AM/AM (vector)
AMPM	AM/PM (vector)
DAMam	AM/AM (dot)
DAMPm	AM/PM (dot)
CCDF	CCDF
PDF	PDF

NOTE. The argument *FVTime* is valid when [:SENSe]:DDEMod:FORMat is *GFSK* or *FSK*.

The argument *PVTime* is valid only when [:SENSe]:DDEMod:FORMat is *ASK*.

The display format is restricted by the modulation type. Refer to the *RSA3303A User Manual* for details.

Measurement Modes

DEMDDEM

Examples

:DISPlay:DDEMod:SVIew:FORMat CONSte
displays the constellation in the subview.

Related Commands

:DISPlay:DDEMod:MVIew:FORMat, [:SENSe]:DDEMod:FORMat

:DISPlay:DDEMod:SVIew:HSSHift(?)

Selects or queries the Q data half symbol shift for an OQPSK modulation signal on the subview during the digital modulation analysis.

NOTE. This command is valid when [:SENSe]:DDEMod:FORMat is set to OQPSK. This command setting affects the :DISPLay:DDEMod:MVIew:HSSHift command setting immediately.

Syntax :DISPLay:DDEMod:MVIew:HSSHift { LEFT | NONE | RIGHT }
:DISPLay:DDEMod:MVIew:HSSHift?

Arguments LEFT shifts Q data by half a symbol in the negative direction on the time axis.
NONE does not shift Q data (default).
RIGHT shifts Q data by half a symbol in the positive direction on the time axis.

Measurement Modes DEMDDEM

Examples :DISPLay:DDEMod:MVIew:HSSHift LEFT
specifies that half a symbol of Q data is shifted to the left side.

Related Commands :DISPLay:DDEMod:MVIew:HSSHift, [:SENSe]:DDEMod:FORMat

:DISPlay:DDEMod:SVIew:RADix(?)

Selects or queries the base of symbols in the subview during the digital modulation analysis.

This command is valid when :DISPlay:DDEMod:SVIew:FORMat is set to STABLE (symbol table).

Syntax :DISPlay:DDEMod:SVIew:RADix { BINary | OCTal | HEXadecimal }
:DISPlay:DDEMod:SVIew:RADix?

Arguments BINary selects binary notation.
OCTal selects octal notation.
HEXadecimal selects hexadecimal notation.

Measurement Modes DEMDDEM

Examples :DISPlay:DDEMod:SVIew:RADix BINary
selects binary notation for the symbol table.

Related Commands :DISPlay:DDEMod:SVIew:FORMat

:DISPlay:DDEMod:SVIew:X[:SCALe]:OFFSet(?)

Sets or queries the minimum horizontal value (left edge) in the subview during the digital modulation analysis.

This command is not available when :DISPlay:DDEMod:SVIew:FORMat is set to CONSTe, VECTor, IEYE, QEYE, TEYE, or STABLE.

Syntax :DISPlay:DDEMod:SVIew:X[:SCALe]:OFFSet <value>
 :DISPlay:DDEMod:SVIew:X[:SCALe]:OFFSet?

Arguments <value>::=<NRf> specifies the minimum horizontal value in the subview. The valid range depends on the display format. Refer to Table D–1 in *Appendix D*.

Measurement Modes DEMDDEM

Examples :DISPlay:DDEMod:SVIew:X:SCALe:OFFSet -2.5
 sets the minimum horizontal value to –2.5 when the subview displays the constellation.

Related Commands :DISPlay:DDEMod:SVIew:FORMat

:DISPlay:DDEMod:SVIew:X[:SCALe]:RANGe(?)

Sets or queries full-scale value of the horizontal axis in the subview during the digital modulation analysis.

This command is not available when :DISPlay:DDEMod:MVIew:FORMat is set to CONSTe, VECTor, IEYE, QEYE, TEYE, STABLE, AMAM, AMPM, DAMam or DAMPm.

Syntax :DISPlay:DDEMod:SVIew:X[:SCALe]:RANGe <value>

:DISPlay:DDEMod:SVIew:X[:SCALe]:RANGe?

Arguments <value>::=<NRf> specifies full-scale value of the horizontal axis in the subview. The valid range depends on the display format. Refer to Table D-1 in *Appendix D*.

Measurement Modes DEMDDEM

Examples :DISPlay:DDEMod:SVIew:X:SCALe:RANGe 2.5
sets full-scale value of the horizontal axis to 2.5 when the subview displays the constellation.

Related Commands :DISPlay:DDEMod:SVIew:FORMat

:DISPlay:DDEMod:SVIew:Y[:SCALe]:FIT (No Query Form)

Runs the auto-scale on the subview during the digital modulation analysis. The auto-scale automatically sets the start value and scale of the vertical axis to display the whole waveform.

This command is not available when :DISPlay:DDEMod:MVIew:FORMat is set to CONSTe, VECTor, IEYE, QEYE, TEYE, STABle, AMAM, AMPM, DAMam or DAMPm.

Syntax :DISPlay:DDEMod:SVIew:Y[:SCALe]:FIT

Arguments None

Measurement Modes DEMDDEM

Examples :DISPlay:DDEMod:SVIew:Y:SCALe:FIT
runs the auto-scale on the subview.

Related Commands :DISPlay:DDEMod:SVIew:FORMat

:DISPlay:DDEMod:SVIew:Y[:SCALe]:FULL (No Query Form)

Sets the vertical axis in the subview to the default full-scale value during the digital modulation analysis.

This command is not available when :DISPlay:DDEMod:MVIew:FORMat is set to CONSTe, VECTor, IEYE, QEYE, TEYE, STABle, AMAM, AMPM, DAMam or DAMPm.

Syntax :DISPlay:DDEMod:SVIew:Y[:SCALe]:FULL

Arguments None

Measurement Modes DEMDDEM

Examples :DISPlay:DDEMod:SVIew:Y:SCALe:FULL
sets the vertical axis in the subview to the default full-scale value.

Related Commands :DISPlay:DDEMod:SVIew:FORMat

:DISPlay:DDEMod:SVIew:Y[:SCALe]:MAXimum(?)

Sets or queries the maximum vertical value (top end) in the CCDF subview during the digital modulation analysis.

This command is valid when :DISPlay:DDEMod:SVIew:FORMat is set to CCDF.

Syntax :DISPlay:DDEMod:SVIew:Y[:SCALe]:MAXimum <value>
:DISPlay:DDEMod:SVIew:Y[:SCALe]:MAXimum?

Arguments <value>::=<NRf> specifies the maximum vertical value in the CCDF view.
Range: Twice of the minimum value to 100%
The minimum value is set using the :DISPlay:DDEMod:SVIew:Y[:SCALe]:MINimum command.

Measurement Modes DEMDDEM

Examples :DISPlay:DDEMod:SVIew:Y:SCALe:MAXimum 80pct
sets the maximum vertical value to 80% in the CCDF subview.

Related Commands :DISPlay:DDEMod:SVIew:Y[:SCALe]:MINimum

:DISPlay:DDEMod:SVIew:Y[:SCALe]:MINimum(?)

Sets or queries the minimum vertical value (bottom end) in the CCDF subview during the digital modulation analysis.

This command is valid when :DISPlay:DDEMod:SVIew:FORMat is set to CCDF.

Syntax :DISPlay:DDEMod:SVIew:Y[:SCALe]:MINimum <value>
 :DISPlay:DDEMod:SVIew:Y[:SCALe]:MINimum?

Arguments <value>::=<NRf> specifies the minimum vertical value in the CCDF view.
 Range: 0.01 to 1/2 of the maximum value in percent (%)

The maximum value is set using the :DISPlay:DDEMod:SVIew:Y[:SCALe]:MAXimum command.

Measurement Modes DEMDDEM

Examples :DISPlay:DDEMod:SVIew:Y:SCALe:MINimum 0.1pct
 sets the minimum vertical value to 0.1% in the CCDF subview.

Related Commands :DISPlay:DDEMod:SVIew:Y[:SCALe]:MAXimum

:DISPlay:DDEMod:SVIew:Y[:SCALe]:OFFSet(?)

Sets or queries the minimum vertical value (bottom) in the subview during the digital modulation analysis.

This command is not available when :DISPlay:DDEMod:SVIew:FORMat is set to CONSTe, VECTor, IEYE, QEYE, TEYE, STABLE, AMPM, DAMPm, or CCDF.

The query command is valid when :DISPlay:DDEMod:SVIew:FORMat is set to AMAM.

Syntax :DISPlay:DDEMod:SVIew:Y[:SCALe]:OFFSet <value>

Arguments <value>::=<NRf> specifies the minimum vertical value in the subview. The valid range depends on the display format. Refer to Table D–1 in *Appendix D*.

Measurement Modes DEMDDEM

Examples :DISPlay:DDEMod:SVIew:Y:SCALe:OFFSet -100
sets the minimum vertical value to –100 dBm when the subview displays spectrum.

Related Commands :DISPlay:DDEMod:SVIew:FORMat

:DISPlay:DDEMod:SVIew:Y[:SCALe]:RANGe(?)

Sets or queries full-scale value of the vertical axis in the subview during the digital modulation analysis.

This command is not available when :DISPlay:DDEMod:SVIew:FORMat is set to CONSTe, VECTor, IEYE, QEYE, TEYE, STABLE, AMAM, DAMam, or CCDF.

Syntax :DISPlay:DDEMod:SVIew:Y[:SCALe]:RANGe <value>

:DISPlay:DDEMod:SVIew:Y[:SCALe]:RANGe?

Arguments <value> ::= <NRf> specifies full-scale value of the vertical axis in the subview. The valid range depends on the display format. Refer to Table D–1 in *Appendix D*.

Measurement Modes DEMDEM

Examples :DISPlay:DDEMod:SVIew:Y:SCALe:RANGe 100
sets full-scale value of the vertical axis to 100 dB when the subview displays spectrum.

Related Commands :DISPlay:DDEMod:SVIew:FORMat

:DISPlay:OView Subgroup

The :DISPlay:OView commands set up the overview in the Demod (modulation analysis) and Time (time analysis) modes.

Command Tree	Header	Parameter
	:DISPlay	
	:OView	
	:FORMat	WAVeform SGRam
	:OTINdicator	<boolean>
	:SGRam	
	:COLor	
	[:SCALE]	
	:OFFSet	<amplitude>
	:RANge	<relative_amplitude>
	:X	
	[:SCALE]	
	:OFFSet	<frequency>
	:SPAN	<frequency>
	:Y	
	[:SCALE]	
	:OFFSet	<frame_count>
	:PLINe	<frame_count>
	:WAVeform	
	:X	
	[:SCALE]	
	:OFFSet	<time>
	:PDIVision	<time>
	:Y	
	[:SCALE]	
	:FIT	
	:FULL	
	:OFFSet	<amplitude>
	:PDIVision	<amplitude>

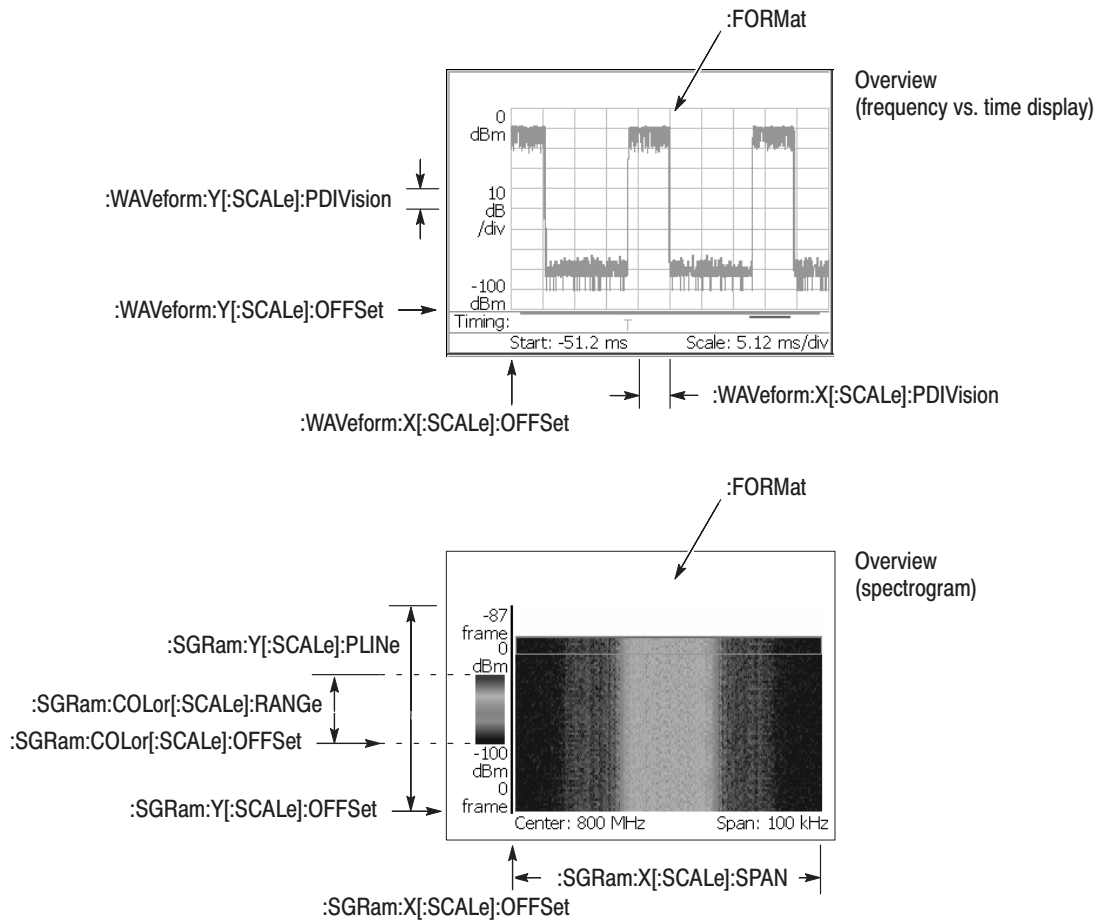

NOTE: Command header :DISPlay:OVlew is omitted here.

Figure 2-10: :DISPlay:OVlew command setting

:DISPlay:OView:FORMat(?)

Selects or queries the overview display format.

Syntax :DISPlay:OView:FORMat { WAVeform | SGRam }
:DISPlay:OView:FORMat?

Arguments WAVeform displays the amplitude vs. time view.
SGRam displays the spectrogram.

Measurement Modes DEMADEM, DEMDDEM, TIMCCDF, TIMTRAN, TIMPULSE

Examples :DISPlay:OView:FORMat SGRam
displays the spectrogram view in the overview.

:DISPlay:OView:OTINdicator(?)

Determines whether to show the trigger output indicator (“O”) in the overview.

Syntax :DISPlay:OView:OTINdicator { OFF | ON | 0 | 1 }
:DISPlay:OView:OTINdicator?

Arguments OFF or 0 hides the trigger output indicator.
ON or 1 shows the trigger output indicator.

Measurement Modes DEMADEM, DEMDDEM, TIMCCDF, TIMTRAN, TIMPULSE

Examples :DISPlay:OView:OTINdicator ON
shows the trigger output indicator.

:DISPlay:OView:SGRam:COLor[:SCALE]:OFFSet(?)

Sets or queries the minimum value (bottom end) of the color, or amplitude, axis when the overview displays a spectrogram.

Syntax :DISPlay:OView:SGRam:COLor[:SCALE]:OFFSet <amp1>

 :DISPlay:OView:SGRam:COLor[:SCALE]:OFFSet?

Arguments <amp1>::=<NRf> specifies the minimum color-axis value in the overview.
Range: -200 to +100 dBm.

Measurement Modes DEMADEM, DEMDDEM, TIMCCDF, TIMTRAN, TIMPULSE

Examples :DISPlay:OView:SGRam:COLor:SCALE:OFFSet -100
 sets the minimum color-axis value to -100 dBm.

:DISPlay:OView:SGRam:COLor[:SCALE]:RANGe(?)

Sets or queries full-scale value of the color, or amplitude, axis when the overview displays a spectrogram.

Syntax :DISPlay:OView:SGRam:COLor[:SCALE]:RANGe <rel_amp1>

 :DISPlay:OView:SGRam:COLor[:SCALE]:RANGe?

Arguments <rel_amp1>::={ 10 | 20 | 50 | 100 } [dB] specifies the full-scale value of the color axis.

Measurement Modes DEMADEM, DEMDDEM, TIMCCDF, TIMTRAN, TIMPULSE

Examples :DISPlay:OView:SGRam:COLor:SCALE:RANGe 100
 sets full-scale value of the color axis to 100 dB.

:DISPlay:OView:SGRam:X[:SCALe]:OFFSet(?)

Sets or queries the minimum horizontal, or frequency, value (left end) when the overview displays a spectrogram.

Syntax :DISPlay:OView:SGRam:X[:SCALe]:OFFSet <freq>
:DISPlay:OView:SGRam:X[:SCALe]:OFFSet?

Arguments <freq>::=<NRf> specifies the minimum horizontal value of the spectrogram. The valid range depends on the setting in the [:SENSe]:FREQuency:BAND command. Refer to Table 2–46 on page 2–328.

Measurement Modes DEMADEM, DEMDDEM, TIMCCDF, TIMTRAN, TIMPULSE

Examples :DISPlay:OView:SGRam:X:SCALe:OFFSet 100MHz
sets the minimum horizontal value to 100 MHz.

:DISPlay:OView:SGRam:X[:SCALe]:SPAN(?)

Sets or queries the span of the horizontal, or frequency, axis when the overview displays a spectrogram.

Syntax :DISPlay:OView:SGRam:X[:SCALe]:SPAN <freq>
:DISPlay:OView:SGRam:X[:SCALe]:SPAN?

Arguments <freq>::=<NRf> specifies the horizontal span.
Range: 100 Hz to 10 MHz (RF)
100 Hz to 20 MHz (baseband with option 05)

Measurement Modes DEMADEM, DEMDDEM, TIMCCDF, TIMTRAN, TIMPULSE

Examples :DISPlay:OView:SGRam:X:SCALe:SPAN 100kHz
sets the span to 100 kHz.

:DISPlay:OVlew:SGRam:Y[:SCALe]:OFFSet(?)

Sets or queries the minimum vertical, or frame number, value (bottom end) when the overview displays a spectrogram.

Syntax :DISPlay:OVlew:SGRam:Y[:SCALe]:OFFSet <value>

 :DISPlay:OVlew:SGRam:Y[:SCALe]:OFFSet?

Arguments <value>::=<NR1> specifies the minimum vertical value of the spectrogram.
Range: Frame # -63999 to 0.

Measurement Modes DEMADEM, DEMDDEM, TIMCCDF, TIMTRAN, TIMPULSE

Examples :DISPlay:OVlew:SGRam:Y:SCALe:OFFSet -100
 sets the minimum vertical value to frame # -100.

:DISPlay:OVlew:SGRam:Y[:SCALe]:PLINe(?)

Sets or queries the vertical scale (the number of frames per line) when the overview displays a spectrogram.

Frames are thinned out from all the acquired framed data at intervals of the number of frames specified in this command, before the spectrogram is displayed. For example, if you set the argument to 5, the data will be displayed every 5 frames.

Syntax :DISPlay:OVlew:SGRam:Y[:SCALe]:PLINe <value>

 :DISPlay:OVlew:SGRam:Y[:SCALe]:PLINe?

Arguments <value>::=<NR1> specifies the vertical scale for the spectrogram.
Range: 1 to 1024 frames per line.

Measurement Modes DEMADEM, DEMDDEM, TIMCCDF, TIMTRAN, TIMPULSE

Examples :DISPlay:OVlew:SGRam:Y:SCALe:PLINe 5
 displays the data in the spectrogram every 5 frames.

:DISPlay:OView:WAVEform:X[:SCALE]:OFFSet(?)

Sets or queries the minimum horizontal, or time, value (left end) when the overview displays an amplitude vs. time waveform.

Syntax :DISPlay:OView:WAVEform:X[:SCALE]:OFFSet <time>
:DISPlay:OView:WAVEform:X[:SCALE]:OFFSet?

Arguments <time>::=<NRf> specifies the minimum horizontal value. Range: -32000 to 0 s.

Measurement Modes DEMADEM, DEMDDEM, TIMCCDF, TIMTRAN, TIMPULSE

Examples :DISPlay:OView:WAVEform:X:SCALE:OFFSet -100us
sets the minimum horizontal value to -100 μ s.

:DISPlay:OView:WAVEform:X[:SCALE]:PDIVision(?)

Sets or queries the horizontal, or time, scale (per division) when the overview displays an amplitude vs. time view.

Syntax :DISPlay:OView:WAVEform:X[:SCALE]:PDIVision <time>
:DISPlay:OView:WAVEform:X[:SCALE]:PDIVision?

Arguments <time>::=<NRf> specifies the horizontal scale. Range: 0 to 3200 s/div.

Measurement Modes DEMADEM, DEMDDEM, TIMCCDF, TIMTRAN, TIMPULSE

Examples :DISPlay:OView:WAVEform:X:SCALE:PDIVision 10.0E-6
sets the horizontal scale to 10 μ s/div.

:DISPlay:OView:WAVeform:Y[:SCALe]:FIT (No Query Form)

Runs the auto-scale on the overview. The auto-scale automatically sets the start value and scale of the vertical axis to display the whole waveform.

Syntax :DISPlay:OView:WAVeform:Y[:SCALe]:FIT

Arguments None

Measurement Modes DEMADEM, DEMDDEM, TIMCCDF, TIMTRAN, TIMPULSE

Examples :DISPlay:OView:WAVeform:Y:SCALe:FIT
runs the auto-scale on the overview.

:DISPlay:OView:WAVeform:Y[:SCALe]:FULL (No Query Form)

Sets the vertical axis in the overview to the default full-scale value.

Syntax :DISPlay:OView:WAVeform:Y[:SCALe]:FULL

Arguments None

Measurement Modes DEMADEM, DEMDDEM, TIMCCDF, TIMTRAN, TIMPULSE

Examples :DISPlay:OView:WAVeform:Y:SCALe:FULL
sets the overview's vertical axis to the default full-scale value.

:DISPlay:OView:WAVeform:Y[:SCALe]:OFFSet(?)

Sets or queries the minimum vertical, or amplitude, value (bottom end) when the overview displays an amplitude vs. time waveform.

Syntax :DISPlay:OView:WAVeform:Y[:SCALe]:OFFSet <ampl>
 :DISPlay:OView:WAVeform:Y[:SCALe]:OFFSet?

Arguments <ampl>::=<NRf> specifies the minimum vertical value.
 Range: -200 to 0 dBm.

Measurement Modes DEMADEM, DEMDDEM, TIMCCDF, TIMTRAN, TIMPULSE

Examples :DISPlay:OView:WAVeform:Y:SCALe:OFFSet -100
 sets the minimum vertical value to -100 dBm.

:DISPlay:OView:WAVeform:Y[:SCALe]:PDIVision(?)

Sets or queries the vertical, or amplitude, scale (per division) when the overview displays an amplitude vs. time waveform.

Syntax :DISPlay:OView:WAVeform:Y[:SCALe]:PDIVision <ampl>
 :DISPlay:OView:WAVeform:Y[:SCALe]:PDIVision?

Arguments <ampl>::=<NRf> specifies the vertical scale. Range: 0 to 30 dB/div.

Measurement Modes DEMADEM, DEMDDEM, TIMCCDF, TIMTRAN, TIMPULSE

Examples :DISPlay:OView:WAVeform:Y:SCALe:PDIVision 10
 sets the vertical scale to 10 dB/div.

:DISPlay:PULSe:MVlew|:SVlew Subgroup

The :DISPlay:PULSe:MVlew|:SVlew commands control display of the main view (pulse result table) and subview in the pulse characteristics analysis.

NOTE. To use a command from this group, you must have selected *TIMPULSE* (pulse characteristics analysis) in the :INSTRument[:SElect] command.

Command Tree	Header	Parameter
	:DISPlay	
	:PULSe	
	:MVlew	
	:RESult	
	:CHPower	<boolean>
	:DCYClE	<boolean>
	:EBWidth	<boolean>
	:FREQuency	<boolean>
	:OBWidth	<boolean>
	:OORatio	<boolean>
	:PERiod	<boolean>
	:PHASe	<boolean>
	:PPOWer	<boolean>
	:RIPPlE	<boolean>
	:WIDTh	<boolean>
	:SVlew	
	:FORMat	WIDTh PPOWer OORatio RIPPlE PERiod DCYClE PHASe CHPower OBWidth EBWidth FREQuency
	:GUIDelines	<boolean>
	:RANGe	ADAPtive MAXimum
	:RESult	SINGle ALL
	:SElect	<numeric_value>

:DISPlay:PULSe:MVIew:RESult:CHPower(?)

Determines whether to show channel power measurement results in the pulse result table.

Syntax :DISPlay:PULSe:MVIew:RESult:CHPower { 0 | 1 | OFF | ON }
:DISPlay:PULSe:MVIew:RESult:CHPower?

Arguments OFF or 0 hides channel power measurement results in the pulse result table.
ON or 1 shows channel power measurement results in the pulse result table.

Measurement Modes TIMPULSE

Examples :DISPlay:PULSe:MVIew:RESult:CHPower ON
shows channel power measurement results in the pulse result table.

:DISPlay:PULSe:MVIew:RESult:DCYClE(?)

Determines whether to show duty cycle measurement results in the pulse result table.

Syntax :DISPlay:PULSe:MVIew:RESult:DCYClE { 0 | 1 | OFF | ON }
:DISPlay:PULSe:MVIew:RESult:DCYClE?

Arguments OFF or 0 hides duty cycle measurement results in the pulse result table.
ON or 1 shows duty cycle measurement results in the pulse result table.

Measurement Modes TIMPULSE

Examples :DISPlay:PULSe:MVIew:RESult:DCYClE ON
shows duty cycle measurement results in the pulse result table.

:DISPlay:PULSe:MVIew:RESult:EBWidth(?)

Determines whether to show EBW (Emission Bandwidth) measurement results in the pulse result table.

Syntax :DISPlay:PULSe:MVIew:RESult:EBWidth { 0 | 1 | OFF | ON }
 :DISPlay:PULSe:MVIew:RESult:EBWidth?

Arguments OFF or 0 hides EBW measurement results in the pulse result table.
 ON or 1 shows EBW measurement results in the pulse result table.

Measurement Modes TIMPULSE

Examples :DISPlay:PULSe:MVIew:RESult:EBWidth ON
 shows EBW measurement results in the pulse result table.

:DISPlay:PULSe:MVIew:RESult:FREQuency(?)

Determines whether to show frequency deviation measurement results in the pulse result table.

Syntax :DISPlay:PULSe:MVIew:RESult:FREQuency { 0 | 1 | OFF | ON }
 :DISPlay:PULSe:MVIew:RESult:FREQuency?

Arguments OFF or 0 hides frequency deviation measurement results in the pulse result table.
 ON or 1 shows frequency deviation measurement results in the pulse result table.

Measurement Modes TIMPULSE

Examples :DISPlay:PULSe:MVIew:RESult:FREQuency ON
 shows frequency deviation measurement results in the pulse result table.

:DISPlay:PULSe:MView:RESult:OBWidth(?)

Determines whether to show OBW (Occupied Bandwidth) measurement results in the pulse result table.

Syntax :DISPlay:PULSe:MView:RESult:OBWidth { 0 | 1 | OFF | ON }
:DISPlay:PULSe:MView:RESult:OBWidth?

Arguments OFF or 0 hides OBW measurement results in the pulse result table.
ON or 1 shows OBW measurement results in the pulse result table.

Measurement Modes TIMPULSE

Examples :DISPlay:PULSe:MView:RESult:OBWidth ON
shows OBW measurement results in the pulse result table.

:DISPlay:PULSe:MView:RESult:OORatio(?)

Determines whether to show on/off-ratio measurement results in the pulse result table.

Syntax :DISPlay:PULSe:MView:RESult:OORatio { 0 | 1 | OFF | ON }
:DISPlay:PULSe:MView:RESult:OORatio?

Arguments OFF or 0 hides on/off-ratio measurement results in the pulse result table.
ON or 1 shows on/off-ratio measurement results in the pulse result table.

Measurement Modes TIMPULSE

Examples :DISPlay:PULSe:MView:RESult:OORatio ON
shows on/off-ratio measurement results in the pulse result table.

:DISPlay:PULSe:MVIew:RESult:PERiod(?)

Determines whether to show pulse repetition interval measurement results in the pulse result table.

Syntax :DISPlay:PULSe:MVIew:RESult:PERiod { 0 | 1 | OFF | ON }
 :DISPlay:PULSe:MVIew:RESult:PERiod?

Arguments OFF or 0 hides pulse repetition interval measurement results in the pulse result table.

 ON or 1 shows pulse repetition interval measurement results in the pulse result table.

Measurement Modes TIMPULSE

Examples :DISPlay:PULSe:MVIew:RESult:PERiod ON
 shows pulse repetition interval measurement results in the pulse result table.

:DISPlay:PULSe:MVIew:RESult:PHASe(?)

Determines whether to show pulse-pulse phase measurement results in the pulse result table.

Syntax :DISPlay:PULSe:MVIew:RESult:PHASe { 0 | 1 | OFF | ON }
 :DISPlay:PULSe:MVIew:RESult:PHASe?

Arguments OFF or 0 hides pulse-pulse phase measurement results in the pulse result table.

 ON or 1 shows pulse-pulse phase measurement results in the pulse result table.

Measurement Modes TIMPULSE

Examples :DISPlay:PULSe:MVIew:RESult:PHASe ON
 shows pulse-pulse phase measurement results in the pulse result table.

:DISPlay:PULSe:MVIew:RESult:PPOWer(?)

Determines whether to show peak power measurement results in the pulse result table.

Syntax :DISPlay:PULSe:MVIew:RESult:PPOWer { 0 | 1 | OFF | ON }
:DISPlay:PULSe:MVIew:RESult:PPOWer?

Arguments OFF or 0 hides peak power measurement results in the pulse result table.
ON or 1 shows peak power measurement results in the pulse result table.

Measurement Modes TIMPULSE

Examples :DISPlay:PULSe:MVIew:RESult:PPOWer ON
shows peak power measurement results in the pulse result table.

:DISPlay:PULSe:MVIew:RESult:RIPPlE(?)

Determines whether to show pulse ripple measurement results in the pulse result table.

Syntax :DISPlay:PULSe:MVIew:RESult:RIPPlE { 0 | 1 | OFF | ON }
:DISPlay:PULSe:MVIew:RESult:RIPPlE?

Arguments OFF or 0 hides pulse ripple measurement results in the pulse result table.
ON or 1 shows pulse ripple measurement results in the pulse result table.

Measurement Modes TIMPULSE

Examples :DISPlay:PULSe:MVIew:RESult:RIPPlE ON
shows pulse ripple measurement results in the pulse result table.

:DISPlay:PULSe:MVIew:RESuLt:WIDTh(?)

Determines whether to show pulse width measurement results in the pulse result table.

Syntax :DISPlay:PULSe:MVIew:RESuLt:WIDTh { 0 | 1 | OFF | ON }
 :DISPlay:PULSe:MVIew:RESuLt:WIDTh?

Arguments OFF or 0 hides peak power measurement results in the pulse result table.
 ON or 1 shows peak power measurement results in the pulse result table.

Measurement Modes TIMPULSE

Examples :DISPlay:PULSe:MVIew:RESuLt:WIDTh ON
 shows peak power measurement results in the pulse result table.

:DISPlay:PULSe:SVIew:FORMat(?)

Selects or queries the display format of the subview in the pulse characteristics analysis.

Syntax :DISPlay:PULSe:SVIew:FORMat { WIDTH | PPOWer | OORatio | RIPPlE
| PERIod | DCYClE | PHASe | CHPower | OBWidth | EBWidth
| FREQuency }

:DISPlay:PULSe:SVIew:FORMat?

Arguments The arguments and display formats are listed below:

Table 2-33: Subview display format

Argument	Display format
WIDTH	Pulse width
PPOWer	Peak power in the pulse-on time
OORatio	Difference between the on-time power and off-time power
RIPPlE	Difference between the maximum and minimum power in the pulse-on time
PERIod	Time between a pulse rising edge and the next pulse rising edge
DCYClE	Ratio of the pulse width to the pulse repetition interval (PRI)
PHASe	Phase at a certain point in each pulse
CHPower	Channel power of the pulse-on time spectrum
OBWidth	OBW of the pulse-on time spectrum
EBWidth	EBW of the pulse-on time spectrum
FREQuency	Frequency deviation of the pulse-on time

Measurement Modes TIMPULSE

Examples :DISPlay:PULSe:SVIew:FORMat WIDTH
displays the pulse width measurement result and waveform in the subview.

:DISPlay:PULSe:SVIew:GUIDelines(?)

Determines whether to show the guidelines in the subview.

Syntax :DISPlay:PULSe:SVIew:GUIDelines { 0 | 1 | OFF | ON }
 :DISPlay:PULSe:SVIew:GUIDelines?

Arguments OFF or 0 hides the guidelines in the subview.
 ON or 1 shows the guidelines in the subview (default).

Measurement Modes TIMPULSE

Examples :DISPlay:PULSe:SVIew:GUIDelines ON
 shows the guidelines in the subview.

:DISPlay:PULSe:SVIew:RANGe(?)

Selects or queries how to set the horizontal scale in the subview.

Syntax :DISPlay:PULSe:SVIew:RANGe { ADAPtive | MAXimum }
 :DISPlay:PULSe:SVIew:RANGe?

Arguments ADAPtive adjusts the horizontal scale for each pulse to fit the pulse width to the subview (default).
 MAXimum adjusts the horizontal scale to fit the maximum pulse width in the analysis range to the subview.

Measurement Modes TIMPULSE

Examples :DISPlay:PULSe:SVIew:RANGe ADAPtive
 adjusts the horizontal scale for each pulse to fit the pulse width to the subview.

:DISPlay:PULSe:SVIew:RESult(?)

Selects or queries how to show the result graph in the subview.

Syntax :DISPlay:PULSe:SVIew:RESult { SINGle | ALL }
:DISPlay:PULSe:SVIew:RESult?

Arguments SINGle shows the measurement result and waveform for a pulse in the subview. Select the pulse using the :DISPlay:PULSe:SVIew:SElect command.

ALL shows the measurement results for all pulses in the subview, representing pulse numbers along the horizontal axis and measurement values along the vertical axis.

Measurement Modes TIMPULSE

Examples :DISPlay:PULSe:SVIew:RESult SINGle
shows the measurement result and waveform for a pulse in the subview.

Related Commands :DISPlay:PULSe:SVIew:SElect

:DISPlay:PULSe:SVIew:SElect(?)

Selects or queries a pulse to measure when you select SINGle with the :DISPlay:PULSe:SVIew:RESult command.

Syntax :DISPlay:PULSe:SVIew:SElect <number>
:DISPlay:PULSe:SVIew:SElect?

Arguments <number>::=<NR1> specifies the a single pulse number. 0 (zero) represents the latest pulse. The older pulse has the larger negative number. Range: -999 to 0

Measurement Modes TIMPULSE

Examples :DISPlay:PULSe:SVIew:RESult -125
specifies pulse #-125 to display in the subview.

:DISPlay:PULSe:SPECTrum Subgroup

The :DISPlay:PULSe:SPECTrum commands control the spectrum display in the frequency domain measurements under the pulse characteristics analysis.

These commands are valid when you select one of the following items using the :DISPlay:PULSe:SVIew:FORMat command.

- CHPower (channel power)
- OBWidth (OBW)
- EBWidth (EBW)

NOTE. To use a command from this group, you must have selected *TIMPULSE* (pulse characteristics analysis) in the :INSTRument[:SElect] command.

Command Tree	Header	Parameter
	:DISPlay	
	:PULSe	
	:SPECTrum	
	:X	
	[:SCALE]	
	:OFFSet	<numeric_value>
	:PDIVision	<numeric_value>
	:Y	
	[:SCALE]	
	:FIT	
	:FULL	
	:OFFSet	<numeric_value>
	:PDIVision	<numeric_value>

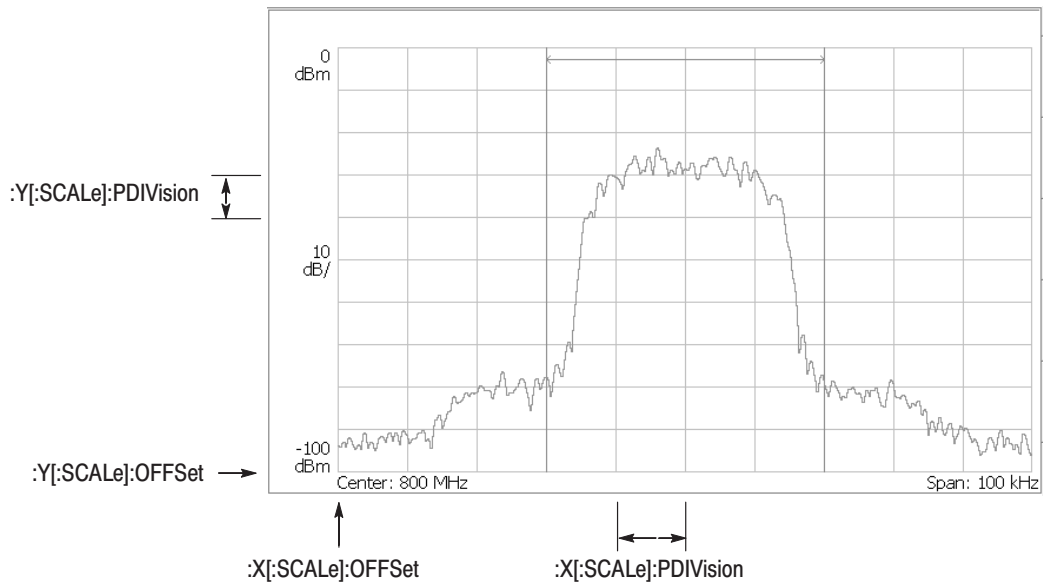

NOTE: Command header :DISPlay:PULSe:SPECTrum is omitted here.

Figure 2-11: :DISPlay:PULSe:SPECTrum command setting

:DISPlay:PULSe:SPECTrum:X[:SCALe]:OFFSet(?)

Sets or queries the minimum horizontal, or frequency, value (left edge) in the spectrum view.

Syntax :DISPlay:PULSe:SPECTrum::X[:SCALe]:OFFSet <freq>

 :DISPlay:PULSe:SPECTrum::X[:SCALe]:OFFSet?

Arguments <freq>::=<NRf> specifies the minimum horizontal value in the spectrum view. For the setting range, refer to *Note on Horizontal Scaling* on page 2–84.

Measurement Modes TIMPULSE

Examples :DISPlay:PULSe:SPECTrum:X:SCALe:OFFSet 100MHz
 sets the minimum horizontal value to 100 MHz.

:DISPlay:PULSe:SPECTrum:X[:SCALe]:PDIVision(?)

Sets or queries the horizontal, or frequency, scale (per division) in the spectrum view.

Syntax :DISPlay:PULSe:SPECTrum:X[:SCALe]:PDIVision <freq>

 :DISPlay:PULSe:SPECTrum:X[:SCALe]:PDIVision?

Arguments <freq>::=<NRf> specifies the horizontal scale. For the setting range, refer to *Note on Horizontal Scaling* on page 2–84.

Measurement Modes TIMPULSE

Examples :DISPlay:PULSe:SPECTrum:X:SCALe:PDIVision 100.0E+3
 sets the horizontal scale to 100 kHz/div.

:DISPlay:PULSe:SPECtrum:Y[:SCALe]:FIT (No Query Form)

Runs the auto-scale on the spectrum view. The auto-scale automatically sets the start value and scale of the vertical axis to fit the waveform to the screen.

Syntax :DISPlay:PULSe:SPECtrum:Y[:SCALe]:FIT

Arguments None

Measurement Modes TIMPULSE

Examples :DISPlay:PULSe:SPECtrum:Y:SCALe:FIT
runs the auto-scale on the spectrum view.

:DISPlay:PULSe:SPECtrum:Y[:SCALe]:FULL (No Query Form)

Sets the vertical axis to the default full-scale value in the spectrum view.

Syntax :DISPlay:PULSe:SPECtrum:Y[:SCALe]:FULL

Arguments None

Measurement Modes TIMPULSE

Examples :DISPlay:PULSe:SPECtrum:Y:SCALe:FULL
sets the vertical axis to the default full-scale value in the spectrum view.

:DISPlay:PULSe:SPECTrum:Y[:SCALe]:OFFSet(?)

Sets or queries the minimum vertical, or amplitude, value (bottom) in the spectrum view.

Syntax :DISPlay:PULSe:SPECTrum:Y[:SCALe]:OFFSet <amp1>
 :DISPlay:PULSe:SPECTrum:Y[:SCALe]:OFFSet?

Arguments <amp1>::=<NRf> sets the minimum vertical value. Range: -200 to 0 dBm.

Measurement Modes TIMPULSE

Examples :DISPlay:PULSe:SPECTrum:Y:SCALe:OFFSet -100
 sets the minimum vertical value to -100 dBm.

:DISPlay:PULSe:SPECTrum:Y[:SCALe]:PDIVision(?)

Sets or queries the vertical, or amplitude, scale (per division) in the spectrum view.

Syntax :DISPlay:PULSe:SPECTrum:Y[:SCALe]:PDIVision <amp1>
 :DISPlay:PULSe:SPECTrum:Y[:SCALe]:PDIVision?

Arguments <amp1>::=<NRf> specifies the vertical scale in the spectrum view.
 Range: 0 to 10 dB/div.

Measurement Modes TIMPULSE

Examples :DISPlay:PULSe:SPECTrum:Y:SCALe:PDIVision 10
 sets the vertical scale to 10 dB/div.

:DISPlay:PULSe:WAVeform Subgroup

The :DISPlay:PULSe:WAVeform commands control the time domain display in the time domain measurements under the pulse characteristics analysis.

These commands are valid when you select one of the following items using the :DISPlay:PULSe:SVIew:FORMat command.

- WIDTH (pulse width)
- PPOWer (peak power)
- OORatio (pulse on/off ratio)
- RIPPlE (pulse ripple)
- PERiod (pulse period)
- DCYCLe (duty cycle)
- PHASe (pulse-pulse phase)
- FREQuency (frequency deviation)

NOTE. To use a command from this group, you must have selected *TIMPULSE* (pulse characteristics analysis) in the *:INSTrument[:SElect]* command.

Command Tree	Header	Parameter
	:DISPlay	
	:PULSe	
	:WAVeform	
	:X	
	[:SCALe]	
	:OFFSet	<numeric_value>
	:PDIVision	<numeric_value>
	:Y	
	[:SCALe]	
	:FIT	
	:FULL	
	:OFFSet	<numeric_value>
	:PDIVision	<numeric_value>

:DISPlay:PULSe:WAVeform:X[:SCALe]:OFFSet(?)

Sets or queries the minimum value of the horizontal axis (left edge) in the time domain display.

Syntax :DISPlay:PULSe:WAVeform:X[:SCALe]:OFFSet <time>

 :DISPlay:PULSe:WAVeform:X[:SCALe]:OFFSet?

Arguments <time>::=<NRf> sets the minimum horizontal value. Range: -32000 to 0 s.
For the setting range, refer to *Note on Horizontal Scaling* on page 2-84.

Measurement Modes TIMPULSE

Examples :DISPlay:PULSe:WAVeform:X:SCALe:OFFSet -100us
sets the minimum horizontal value to -100 μ s.

:DISPlay:PULSe:WAVeform:X[:SCALe]:PDIVision(?)

Sets or queries the horizontal, or time, scale (per division) in the time domain display.

Syntax :DISPlay:PULSe:WAVeform:X[:SCALe]:PDIVision <time>

 :DISPlay:PULSe:WAVeform:X[:SCALe]:PDIVision?

Arguments <time>::=<NRf> specifies the horizontal scale. Range: 0 to 3200 s/div
For the setting range, refer to *Note on Horizontal Scaling* on page 2-84.

Measurement Modes TIMPULSE

Examples :DISPlay:PULSe:WAVeform:X:SCALe:PDIVision 10us
sets the horizontal scale to 10 μ s/div.

:DISPlay:PULSe:WAVeform:Y[:SCALe]:FIT (No Query Form)

Runs the auto-scale on the time domain display. The auto-scale automatically sets the start value and scale of the vertical axis to fit the waveform to the screen.

Syntax :DISPlay:PULSe:WAVeform:Y[:SCALe]:FIT

Arguments None

Measurement Modes TIMPULSE

Examples :DISPlay:PULSe:WAVeform:Y:SCALe:FIT
runs the auto-scale.

:DISPlay:PULSe:WAVeform:Y[:SCALe]:FULL (No Query Form)

Sets the vertical axis in the time domain display to the default full-scale value.

Syntax :DISPlay:PULSe:WAVeform:Y[:SCALe]:FULL

Arguments None

Measurement Modes TIMPULSE

Examples :DISPlay:PULSe:WAVeform:Y:SCALe:FULL
sets the vertical axis in the time domain display to the default full-scale value.

:DISPlay:PULSe:WAVeform:Y[:SCALe]:OFFSet(?)

Sets or queries the minimum value (bottom) of the vertical axis in the time domain display.

Syntax :DISPlay:PULSe:WAVeform:Y[:SCALe]:OFFSet <amp1>

:DISPlay:PULSe:WAVeform:Y[:SCALe]:OFFSet?

Arguments <amp1>::=<NRf> specifies the minimum value of the vertical axis. The valid range depends on the display format. Refer to Table D-1 in *Appendix D*.

Measurement Modes TIMPULSE

Examples :DISPlay:PULSe:WAVeform:Y:SCALe:OFFSet -100
sets the minimum vertical value to -100 dBm.

:DISPlay:PULSe:WAVeform:Y[:SCALe]:PDIVision(?)

Sets the vertical axis scale (per division) in the time domain display.

Syntax :DISPlay:PULSe:WAVeform:Y[:SCALe]:PDIVision <amp1>

:DISPlay:PULSe:WAVeform:Y[:SCALe]:PDIVision?

Arguments <amp1>::=<NRf> specifies the vertical scale. The valid range depends on the display format. Refer to Table D-1 in *Appendix D*.

Measurement Modes TIMPULSE

Examples :DISPlay:PULSe:WAVeform:Y:SCALe:PDIVision 10
sets the vertical scale to 10 dB/div

:DISPlay:SPECTrum Subgroup

The :DISPlay:SPECTrum commands control the spectrum view.

NOTE. To use a command of this group, you must have a spectrum that is currently displayed in the view, regardless of the measurement mode.

Command Tree	Header	Parameter
	:DISPlay	
	:SPECTrum	
	:BMARker	
	:STATe	<boolean>
	:GRATicule	
	:GRID	OFF FIX FLEX
	:MLINe	
	:AMPLitude	
	:INTerval	<numeric_value>
	:OFFSet	<numeric_value>
	[:STATe]	<boolean>
	:ANNotation	
	[:STATe]	<boolean>
	:FREQuency	
	:INTerval	<numeric_value>
	:OFFSet	<numeric_value>
	[:STATe]	<boolean>
	:X	
	[:SCALE]	
	:OFFSet	<frequency>
	:PDIVision	<frequency>
	:Y	
	[:SCALE]	
	:FIT	
	:FULL	
	:OFFSet	<amplitude>
	:PDIVision	<amplitude>

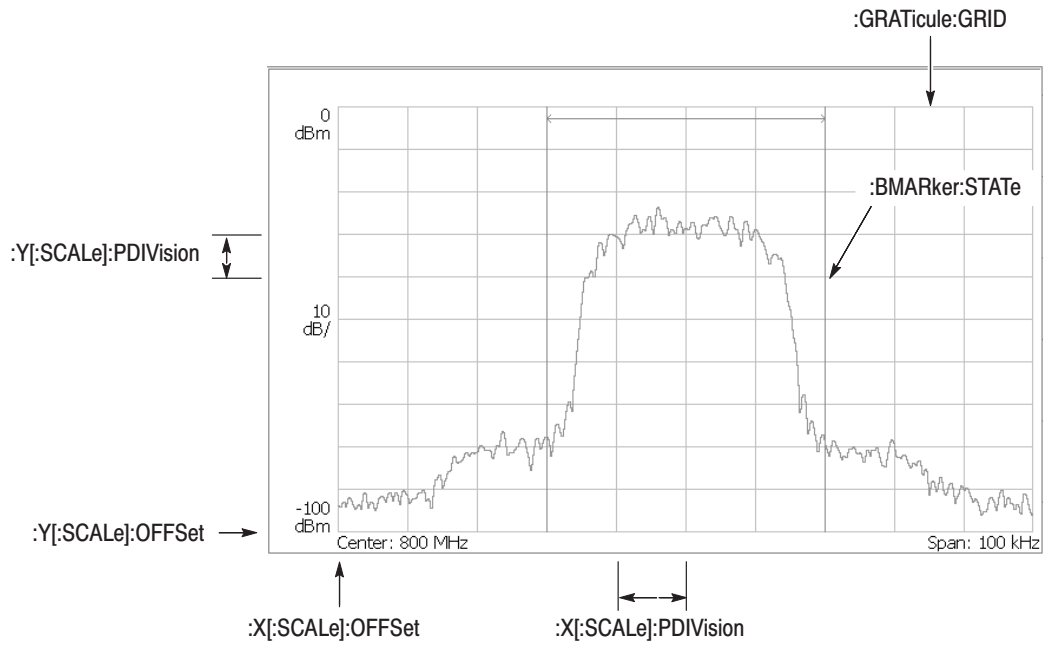

NOTE: Command header :DISPlay:SPECTrum is omitted here.

Figure 2-12: :DISPlay:SPECTrum command setting

:DISPlay:SPECTrum:BMARker:STATe(?)

Determines whether to show the band power marker.

Syntax :DISPlay:SPECTrum:BMARker:STATe { OFF | ON | 0 | 1 }
:DISPlay:SPECTrum:BMARker:STATe?

Arguments OFF or 0 hides the band power marker.
ON or 1 shows the band power marker.

Measurement Modes All

Examples :DISPlay:SPECTrum:BMARker:STATe ON
shows the band power marker.

:DISPlay:SPECTrum:GRATicule:GRID(?)

Selects or queries how the graticule is displayed.

NOTE. This command is available in the S/A (spectrum analysis) mode except Real Time S/A.

Syntax :DISPlay:SPECTrum:GRATicule:GRID { OFF | FIX | FLEX }
:DISPlay:SPECTrum:GRATicule:GRID?

Arguments OFF hides the graticule.
FIX always shows the 10 divisions × 10 divisions graticule.
FLEX shows the graticule so that one division is set in 1-2-5 sequence.

Measurement Modes SANORMAL, SASGRAM

Examples :DISPlay:SPECTrum:GRATicule:GRID FIX
always shows the 10 × 10 graticule.

:DISPlay:SPECTrum:MLINE:AMPLitude:INTerval(?)

Sets or queries the interval of the amplitude multi display lines in the spectrum view.

Syntax :DISPlay:SPECTrum:MLINE:AMPLitude:INTerval <value>
 :DISPlay:SPECTrum:MLINE:AMPLitude:INTerval?

Arguments <value>::=<NRf> sets the interval of the amplitude multi display lines.
Range: 0 to 100 dB.

Measurement Modes SARTIME

Examples :DISPlay:SPECTrum:MLINE:AMPLitude:INTerval 5
sets the interval to 5 dB.

:DISPlay:SPECTrum:MLINE:AMPLitude:OFFSet(?)

Sets or queries the offset of the amplitude multi display lines in the spectrum view.

Syntax :DISPlay:SPECTrum:MLINE:AMPLitude:OFFSet <value>
 :DISPlay:SPECTrum:MLINE:AMPLitude:OFFSet?

Arguments <value>::=<NRf> sets the offset of the amplitude multi display lines.
Range: -100 to 0 dBm.

Measurement Modes SARTIME

Examples :DISPlay:SPECTrum:MLINE:AMPLitude:OFFSet -10
sets the offset to -10 dBm.

:DISPlay:SPECTrum:MLINE:AMPLitude[:STATe](?)

Determines whether to show the amplitude multi display lines in the spectrum view.

Syntax :DISPlay:SPECTrum:MLINE:AMPLitude[:STATe] { OFF | ON | 0 | 1 }
:DISPlay:SPECTrum:MLINE:AMPLitude[:STATe]?

Arguments OFF or 0 hides the amplitude multi display lines.
ON or 1 shows the amplitude multi display lines.

Measurement Modes SARTIME

Examples :DISPlay:SPECTrum:MLINE:AMPLitude:STATe ON
shows the amplitude multi display lines.

:DISPlay:SPECTrum:MLINE:ANNotation[:STATe](?)

Determines whether to show the multi display lines readout in the spectrum view.

Syntax :DISPlay:SPECTrum:MLINE:ANNotation[:STATe] { OFF | ON | 0 | 1 }
:DISPlay:SPECTrum:MLINE:ANNotation[:STATe]?

Arguments OFF or 0 hides the multi display lines readout.
ON or 1 shows the multi display lines readout.

Measurement Modes SARTIME

Examples :DISPlay:SPECTrum:MLINE:ANNotation:STATe ON
shows the readout.

:DISPlay:SPECTrum:MLINE:FREQUENCY:INTERVAL(?)

Sets or queries the interval of the frequency multi display lines in the spectrum view.

Syntax :DISPlay:SPECTrum:MLINE:FREQUENCY:INTERVAL <value>
 :DISPlay:SPECTrum:MLINE:FREQUENCY:INTERVAL?

Arguments <value> ::= <NRf> sets the interval of the frequency multi display lines.
Range: 0 to full span (Hz).

Measurement Modes SARTIME

Examples :DISPlay:SPECTrum:MLINE:FREQUENCY:INTERVAL 1MHz
 sets the interval to 1 MHz.

:DISPlay:SPECTrum:MLINE:FREQUENCY:OFFSET(?)

Sets or queries the offset of the frequency multi display lines in the spectrum view.

Syntax :DISPlay:SPECTrum:MLINE:FREQUENCY:OFFSET <value>
 :DISPlay:SPECTrum:MLINE:FREQUENCY:OFFSET?

Arguments <value> ::= <NRf> sets the offset of the frequency multi display lines.
Range: Center frequency \pm Span/2 (Hz)

The default value is the center frequency; the frequency multi display lines are placed from the center frequency at regular intervals.

Measurement Modes SARTIME

Examples :DISPlay:SPECTrum:MLINE:FREQUENCY:OFFSET 2GHz
 sets the offset to 2 GHz.

:DISPlay:SPECTrum:MLINE:FREQuency[:STATe](?)

Determines whether to show the frequency multi display lines in thr spectrum view.

Syntax :DISPlay:SPECTrum:MLINE:FREQuency[:STATe] { OFF | ON | 0 | 1 }
 :DISPlay:SPECTrum:MLINE:FREQuency[:STATe]?

Arguments OFF or 0 hides the frequency multi display lines.
 ON or 1 shows the frequency multi display lines.

Measurement Modes SARTIME

Examples :DISPlay:SPECTrum:MLINE:FREQuency:STATe ON
 shows the frequency multi display lines.

:DISPlay:SPECTrum:X[:SCALe]:OFFSet(?)

Sets or queries the minimum horizontal, or frequency, value (left end) in the spectrum view.

Syntax :DISPlay:SPECTrum:X[:SCALe]:OFFSet <freq>
 :DISPlay:SPECTrum:X[:SCALe]:OFFSet?

Arguments <freq>::=<Nrf> specifies the minimum horizontal value in the spectrum view. The valid range depends on the measurement frequency band setting in the [:SENSe]:FREQUency:BAND command. Refer to Table 2–46 on page 2–328.

Measurement Modes All

Examples :DISPlay:SPECTrum:X:SCALe:OFFSet 100MHz
 sets the minimum horizontal value to 100 MHz.

:DISPlay:SPECTrum:X[:SCALe]:PDIVision(?)

Sets or queries the horizontal, or frequency, scale (per division) in the spectrum view.

Syntax :DISPlay:SPECTrum:X[:SCALe]:PDIVision <freq>
 :DISPlay:SPECTrum:X[:SCALe]:PDIVision?

Arguments <freq>::=<Nrf> specifies the horizontal scale. Refer to Table 2–46 on page 2–328 for the setting range, where the horizontal scale (/div) = span/10.

Measurement Modes All

Examples :DISPlay:SPECTrum:X:SCALe:PDIVision 100.0E+3
 sets the horizontal scale to 100 kHz/div.

:DISPlay:SPECTrum:Y[:SCALE]:FIT (No Query Form)

Runs the auto-scale on the spectrum view. The auto-scale automatically sets the start value and scale of the vertical axis to display the whole waveform.

Syntax :DISPlay:SPECTrum:Y[:SCALE]:FIT

Arguments None

Measurement Modes All

Examples :DISPlay:SPECTrum:Y:SCALE:FIT
runs the auto-scale on the spectrum view.

:DISPlay:SPECTrum:Y[:SCALE]:FULL (No Query Form)

Sets the vertical axis to the default full-scale value in the spectrum view.

Syntax :DISPlay:SPECTrum:Y[:SCALE]:FULL

Arguments None

Measurement Modes All

Examples :DISPlay:SPECTrum:Y:SCALE:FULL
sets the vertical axis to the default full-scale value in the spectrum view.

:DISPlay:SPECTrum:Y[:SCALe]:OFFSet(?)

Sets or queries the minimum vertical, or amplitude, value (bottom end) in the spectrum view.

Syntax :DISPlay:SPECTrum:Y[:SCALe]:OFFSet <amp1>
 :DISPlay:SPECTrum:Y[:SCALe]:OFFSet?

Arguments <amp1>::=<NRf> sets the minimum vertical value. Range: -200 to 0 dBm.

Measurement Modes All

Examples :DISPlay:SPECTrum:Y:SCALe:OFFSet -100
 sets the minimum vertical value to -100 dBm.

:DISPlay:SPECTrum:Y[:SCALe]:PDIVision(?)

Sets or queries the vertical, or amplitude, scale (per division) in the spectrum view.

Syntax :DISPlay:SPECTrum:Y[:SCALe]:PDIVision <amp1>
 :DISPlay:SPECTrum:Y[:SCALe]:PDIVision?

Arguments <amp1>::=<NRf> specifies the horizontal scale in the spectrum view.
 Range: 0 to 10 dB/div.

Measurement Modes All

Examples :DISPlay:SPECTrum:Y:SCALe:PDIVision 10
 sets the vertical scale to 10 dB/div.

:DISPlay:TFrequency Subgroup

The :DISPlay:TFrequency commands control a three-dimensional view (spectrogram).

NOTE. To use a command of this group, you must have selected SARTIME (Real Time S/A) in the :INSTRument[:SElect] command.

In the SASGRAM (S/A with Spectrogram) mode, you cannot set the scale of the spectrogram.

Command Tree	Header	Parameter
	:DISPlay	
	:TFrequency	
	:SGRam	
	:COLor	
	[:SCALE]	
	:OFFSet	<amplitude>
	:RANge	<relative_amplitude>
	:MLINe	
	:ANNotation	
	[:STATe]	<boolean>
	:FREQuency	
	:INTerval	<numeric_value>
	:OFFSet	<numeric_value>
	[:STATe]	<boolean>
	:TIME	
	:INTerval	<numeric_value>
	:OFFSet	<numeric_value>
	[:STATe]	<boolean>
	:X	
	[:SCALE]	
	:OFFSet	<frequency>
	:SPAN	<frequency>
	:Y	
	[:SCALE]	
	:OFFSet	<frame_count>
	:PLINe	<frame_count>

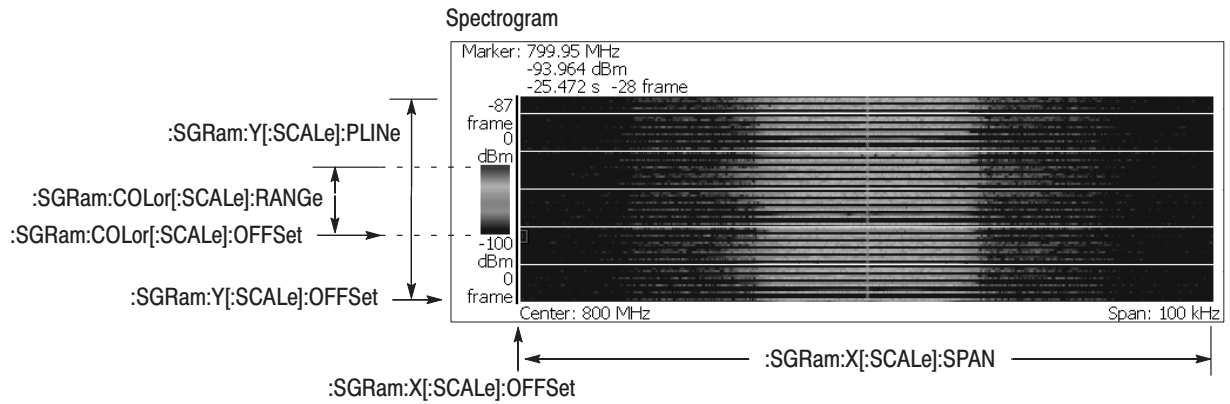

NOTE: Command header `:DISPlay:TFRequency` is omitted here.

Figure 2-13: `:DISPlay:TFRequency` command setting

:DISPlay:TFrequency:SGRam:COLor[:SCALe]:OFFSet(?)

Sets or queries the minimum value (bottom end) of the color, or amplitude, axis in the spectrogram.

Syntax :DISPlay:TFrequency:SGRam:COLor[:SCALe]:OFFSet <amp1>
 :DISPlay:TFrequency:SGRam:COLor[:SCALe]:OFFSet?

Arguments <amp1>::=<NRf> specifies the minimum color-axis value.
 Range: -200 to 0 dBm.

Measurement Modes SARTIME

Examples :DISPlay:TFrequency:SGRam:COLor:SCALe:OFFSet -100
 sets the minimum color-axis value to -100 dBm.

:DISPlay:TFrequency:SGRam:COLor[:SCALe]:RANGe(?)

Sets or queries full-scale value of the color, or amplitude, axis in the spectrogram.

Syntax :DISPlay:TFrequency:SGRam:COLor[:SCALe]:RANGe <rel_amp1>
 :DISPlay:TFrequency:SGRam:COLor[:SCALe]:RANGe?

Arguments <rel_amp1>::={ 10 | 20 | 50 | 100 } [dB] specifies full-scale value of the color axis.

Measurement Modes SARTIME

Examples :DISPlay:TFrequency:SGRam:COLor:SCALe:RANGe 100
 sets full-scale value of the color axis to 100 dB.

:DISPlay:TFRequency:SGRam:MLINE:ANNotation[:STATe](?)

Determines whether to show the multi display lines readout in the spectrogram.

Syntax :DISPlay:TFRequency:SGRam:MLINE:ANNotation[:STATe] { OFF | ON
 | 0 | 1 }

:DISPlay:TFRequency:SGRam:MLINE:ANNotation[:STATe]?

Arguments OFF or 0 hides the multi display lines readout.

ON or 1 shows the multi display lines readout.

Measurement Modes SARTIME

Examples :DISPlay:TFRequency:SGRam:MLINE:ANNotation:STATe ON
 shows the readout.

:DISPlay:TFRequency:SGRam:MLINE:FREQuency:INTerval(?)

Sets or queries the interval of the frequency multi display lines in the spectrogram.

Syntax :DISPlay:TFRequency:SGRam:MLINE:FREQuency:INTerval <value>

:DISPlay:TFRequency:SGRam:MLINE:FREQuency:INTerval?

Arguments <value>::=<NRf> sets the interval of the frequency multi display lines.
Range: 0 to full span (Hz).

Measurement Modes SARTIME

Examples :DISPlay:TFRequency:SGRam:MLINE:FREQuency:INTerval 1MHz
 sets the interval to 1 MHz.

:DISPlay:TFREquency:SGRam:MLINe:FREQuency:OFFSet(?)

Sets or queries the offset of the frequency multi display lines in the spectrogram.

Syntax :DISPlay:TFREquency:SGRam:MLINe:FREQuency:OFFSet <value>
:DISPlay:TFREquency:SGRam:MLINe:FREQuency:OFFSet?

Arguments <value>::=<NRf> sets the offset of the frequency multi display lines.
Range: Center frequency \pm Span/2 (Hz)

The default value is the center frequency; the frequency multi display lines are placed from the center frequency at regular intervals.

Measurement Modes SARTIME

Examples :DISPlay:TFREquency:SGRam:MLINe:FREQuency:OFFSet 2GHz
sets the offset to 2 GHz.

:DISPlay:TFREquency:SGRam:MLINe:FREQuency[:STATe](?)

Determines whether to show the frequency multi display lines in the spectrogram.

Syntax :DISPlay:TFREquency:SGRam:MLINe:FREQuency[:STATe] { OFF | ON
| 0 | 1 }
:DISPlay:TFREquency:SGRam:MLINe:FREQuency[:STATe]?

Arguments OFF or 0 hides the frequency multi display lines.
ON or 1 shows the frequency multi display lines.

Measurement Modes SARTIME

Examples :DISPlay:TFREquency:SGRam:MLINe:FREQuency:STATe ON
shows the frequency multi display lines.

:DISPlay:TFRequency:SGRam:MLINE:TIME:INTerval(?)

Sets or queries the interval of the time multi display lines in the spectrogram.

Syntax :DISPlay:TFRequency:SGRam:MLINE:TIME:INTerval <value>
 :DISPlay:TFRequency:SGRam:MLINE:TIME:INTerval?

Arguments <value>::=<NRf> sets the interval of the time multi display lines.
 Range: 0 second minimum.
 The maximum value depends on acquired data quantity.

Measurement Modes SARTIME

Examples :DISPlay:TFRequency:SGRam:MLINE:TIME:INTerval 1m
 sets the interval to 1 ms.

:DISPlay:TFRequency:SGRam:MLINE:TIME:OFFSet(?)

Sets or queries the offset of the time multi display lines in the spectrogram.

Syntax :DISPlay:TFRequency:SGRam:MLINE:TIME:OFFSet <value>
 :DISPlay:TFRequency:SGRam:MLINE:TIME:OFFSet?

Arguments <value>::=<NRf> sets the offset of the time multi display lines.
 Range: 0 second maximum (Zero represents the latest frame.)
 The minimum value depends on acquired data quantity.

Measurement Modes SARTIME

Examples :DISPlay:TFRequency:SGRam:MLINE:TIME:OFFSet -500u
 sets the offset to -500 μ s.

:DISPlay:TFrequency:SGRam:MLINe:TIME[:STATe](?)

Determines whether to show the time multi display lines in thr spectrogram.

Syntax :DISPlay:TFrequency:SGRam:MLINe:TIME[:STATe] { OFF | ON | 0 | 1 }
 :DISPlay:TFrequency:SGRam:MLINe:TIME[:STATe]?

Arguments OFF or 0 hides the time multi display lines.
 ON or 1 shows the time multi display lines.

Measurement Modes SARTIME

Examples :DISPlay:TFrequency:SGRam:MLINe:TIME:STATe ON
 shows the time multi display lines.

:DISPlay:TFrequency:SGRam:X[:SCALe]:OFFSet(?)

Sets or queries the minimum horizontal, or frequency, value (left end) in the spectrogram.

Syntax :DISPlay:TFrequency:SGRam:X[:SCALe]:OFFSet <freq>
 :DISPlay:TFrequency:SGRam:X[:SCALe]:OFFSet?

Arguments <freq>::=<Nrf> specifies the minimum horizontal value in the spectrogram. The valid range depends on the measurement frequency band setting in the [:SENSe]:FREQUENCY:BAND command. Refer to Table 2–46 on page 2–328.

Measurement Modes SARTIME

Examples :DISPlay:TFrequency:SGRam:X:SCALe:OFFSet 100MHz
 sets the minimum horizontal value to 100 MHz.

Related Commands [:SENSe]:FREQUENCY:BAND

:DISPlay:TFrequency:SGRam:X[:SCALe]:SPAN(?)

Sets or queries the horizontal, or frequency, span in the spectrogram.

Syntax :DISPlay:TFrequency:SGRam:X[:SCALe]:SPAN <freq>
 :DISPlay:TFrequency:SGRam:X[:SCALe]:SPAN?

Arguments <freq>::=<Nrf> specifies the horizontal span in the spectrogram. Range: 100 Hz to 15 MHz (RF), 100 Hz to 20 MHz (baseband)

Measurement Modes SARTIME

Examples :DISPlay:TFrequency:SGRam:X:SCALe:SPAN 10MHz
 sets the span to 10 MHz.

:DISPlay:TFrequency:SGRam:Y[:SCALE]:OFFSet(?)

Sets or queries the minimum horizontal, or frame number, value (bottom end) in the spectrogram.

Syntax :DISPlay:TFrequency:SGRam:Y[:SCALE]:OFFSet <value>
 :DISPlay:TFrequency:SGRam:Y[:SCALE]:OFFSet?

Arguments <value>::=<NR1> specifies the minimum vertical value in the spectrogram.
 Range: Frame # –63999 to 0.

Measurement Modes SARTIME

Examples :DISPlay:TFrequency:SGRam:Y:SCALE:OFFSet –100
 sets the minimum vertical value to frame # –100.

:DISPlay:TFrequency:SGRam:Y[:SCALE]:PLINe(?)

Sets or queries the vertical scale (the number of frames per line) when the overview displays a spectrogram.

Frames are thinned out from all the acquired framed data at intervals of the number of frames specified in this command, before the spectrogram is displayed. For example, if you set the argument to 5, the data will be displayed every 5 frames.

Syntax :DISPlay:TFrequency:SGRam:Y[:SCALE]:PLINe <value>
 :DISPlay:TFrequency:SGRam:Y[:SCALE]:PLINe?

Arguments <value>::=<NR1> specifies the vertical scale in the spectrogram.
 Range: 1 to 1024 frames per line.

Measurement Modes SARTIME

Examples :DISPlay:TFrequency:SGRam:Y:SCALE:PLINe 5
 displays the data in the spectrogram every 5 frames.

:DISPlay[:VIEW] Subgroup

The :DISPlay[:VIEW] commands control the display brightness and format.

Command Tree	Header	Parameter
	:DISPlay	
	[:VIEW]	
	:BRIGhtness	<numeric_value>
	:FORMat	V1S V3S V4S VSPL HSPL MULTitude

:DISPlay[:VIEW]:BRIGhtness(?)

Sets or queries the display brightness.

Syntax :DISPlay[:VIEW]:BRIGhtness <value>
 :DISPlay[:VIEW]:BRIGhtness?

Arguments <value>::=<NRf> specifies the brightness. Range: 0 to 1.
 One represents the maximum brightness.

Measurement Modes All

Examples :DISPlay:VIEW:BRIGhtness 1
 sets the display brightness to 1 (maximum).

:DISPlay[:VIEW]:FORMat(?)

Selects or queries the view display format.

Syntax :DISPlay[:VIEW]:FORMat { V1S | V3S | V4S | VSPL | HSPL
 | MULTitude }
 :DISPlay[:VIEW]:FORMat?

Arguments V1S specifies that only View 1 is displayed.
 V3S specifies that only View 3 is displayed.
 V4S specifies that only View 4 is displayed.
 VSPL specifies that Views 1 and 4 are tiled horizontally.
 HSPL specifies that Views 1 and 4 are tiled vertically.
 MULTitude specifies that multiple views are displayed simultaneously.

NOTE. You must have selected SASGRAM or SARTIME with the INSTRUMENT[:SElect] command to use VSPL or HSPL.

You must have selected a measurement mode which has three views to use MULTitude.

Measurement Modes All

Examples :DISPlay:VIEW:FORMat V1S
specifies that only View 1 is displayed.

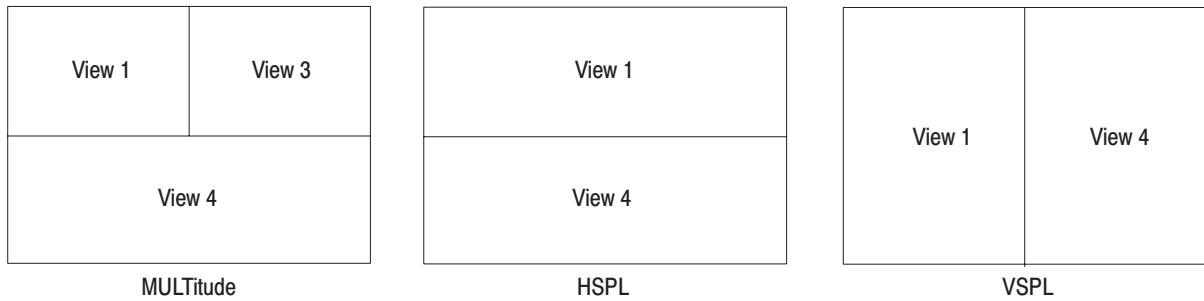

Figure 2-14: View display formats

Related Commands :INSTrument[:SElect]

:DISPlay:WAVeform Subgroup

The :DISPlay:WAVeform commands control the time domain display in the main view in the Demod (modulation analysis) and Time (time analysis) modes. There are six types of time domain display associated with six different measurement items:

- Frequency vs. Time
- I/Q level vs. Time
- Frequency shift vs. Time
- AM demodulation display (percentage modulation vs. time)
- FM demodulation display (frequency shift vs. time)
- PM demodulation display (phase shift vs. time)

NOTE. To use a command of this group, you must have selected *DEMADEM* (analog modulation analysis) or *TIMTRAN* (time characteristic analysis) in the :INSTrument[:SELEct] command.

Command Tree	Header	Parameter
	:DISPlay	
	:WAVeform	
	:X	
	[:SCALe]	
	:OFFSet	<time>
	:PDIVision	<time>
	:Y	
	[:SCALe]	
	:FIT	
	:FULL	
	:OFFSet	<amplitude>
	:PDIVision	<amplitude>

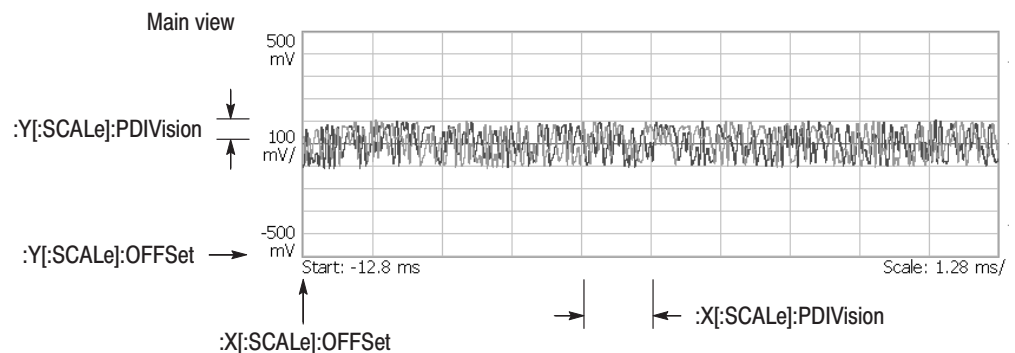

NOTE: Command header :DISPlay:WAVeform is omitted here.

Figure 2-15: :DISPlay:WAVeform command setting

:DISPlay:WAVeform:X[:SCALe]:OFFSet(?)

Sets or queries the minimum value of the horizontal axis (left end) in the time domain display.

Syntax :DISPlay:WAVeform:X[:SCALe]:OFFSet <time>
 :DISPlay:WAVeform:X[:SCALe]:OFFSet?

Arguments <time>::=<NRf> sets the minimum horizontal value. Range: -32000 to 0 s.

Measurement Modes DEMADEM, TIMTRAN

Examples :DISPlay:WAVeform:X:SCALe:OFFSet -100us
 sets the minimum horizontal value to -100 μ s.

:DISPlay:WAVeform:X[:SCALe]:PDIVision(?)

Sets or queries the horizontal, or time, scale (per division) in the time domain display.

Syntax :DISPlay:WAVeform:X[:SCALe]:PDIVision <time>
 :DISPlay:WAVeform:X[:SCALe]:PDIVision?

Arguments <time>::=<NRf> specifies the horizontal scale. Range: 0 to 3200 s/div

Measurement Modes DEMADEM, TIMTRAN

Examples :DISPlay:WAVeform:X:SCALe:PDIVision 10us
 sets the horizontal scale to 10 μ s/div.

:DISPlay:WAVeform:Y[:SCALe]:FIT (No Query Form)

Runs the auto-scale on the time domain display. The auto-scale automatically sets the start value and scale of the vertical axis to display the whole waveform.

Syntax :DISPlay:WAVeform:Y[:SCALe]:FIT

Arguments None

Measurement Modes DEMADEM, TIMTRAN

Examples :DISPlay:WAVeform:Y:SCALe:FIT
runs the auto-scale.

:DISPlay:WAVeform:Y[:SCALe]:FULL (No Query Form)

Sets the vertical axis in the time domain display to the default full-scale value.

Syntax :DISPlay:WAVeform:Y[:SCALe]:FULL

Arguments None

Measurement Modes DEMADEM, TIMTRAN

Examples :DISPlay:WAVeform:Y:SCALe:FULL
sets the vertical axis in the time domain display to the default full-scale value.

:DISPlay:WAVeform:Y[:SCALe]:OFFSet(?)

Sets or queries the minimum value of the vertical axis (bottom end) in the time domain display.

Syntax :DISPlay:WAVeform:Y[:SCALe]:OFFSet <amp1>

 :DISPlay:WAVeform:Y[:SCALe]:OFFSet?

Arguments <amp1>::=<NRf> specifies the minimum value of the vertical axis. The valid range depends on the display format. Refer to Table D-1 in *Appendix D*.

Measurement Modes DEMADEM, TIMTRAN

Examples :DISPlay:WAVeform:Y:SCALe:OFFSet -100
 sets the minimum vertical value to -100 dBm.

:DISPlay:WAVeform:Y[:SCALe]:PDIVision(?)

Sets the vertical axis scale (per division) in the time domain display.

Syntax :DISPlay:WAVeform:Y[:SCALe]:PDIVision <amp1>

 :DISPlay:WAVeform:Y[:SCALe]:PDIVision?

Arguments <amp1>::=<NRf> specifies the vertical scale. The valid range depends on the display format. Refer to Table D-1 in *Appendix D*.

Measurement Modes DEMADEM, TIMTRAN

Examples :DISPlay:WAVeform:Y:SCALe:PDIVision 10
 sets the vertical scale to 10 dB/div

:FETCh Commands

The :FETCh commands retrieve the measurements from the data taken by the latest INITiate command.

If you want to perform a FETCh operation on fresh data, use the :READ commands on page 2–241. The :READ commands acquire a new input signal and fetch the measurement results from that data.

NOTE. *To use a :FETCh command, you must have set a measurement mode for the FETCh operation using the :INSTRument[:SElect] command (refer to page 2–225).*

Command Tree

Header	Parameter
:FETCh	
:ADEMod	
:AM?	
:RESuIt?	
:FM?	
:RESuIt?	
:PM?	
:CCDF?	
:DDEMod?	IQVTime FVTime CONStE EVM AEVM PEVM
(Option 21 only)	MERRor AMERRor PMERRor PERRor
	APERRor PPERror RHO SLEngth FERRor
	OOFFset STABle PVTImE AMAM AMPM
	CCDF PDF
:DISTRibution:CCDF?	
:OVIew?	
:PULSe?	ALL WIDTH PPOWer OORatio RIPPlE
	PERiod DCYClE PHASe CHPower
	OBWidth EBWidth FREQuency
:SPECTrum?	
:TAMPlitude?	
:TFRequency?	
:SPECTrum?	
:ACPower?	
:CFRequency?	
:CHPower?	
:CNRatio?	
:EBWidth?	
:OBWidth?	
:SPURious?	
:TRANsient	
:FVTime?	
:IQVTime?	
:PVTImE?	

:FETCh:ADEMod:AM? (Query Only)

Returns the results of the AM signal analysis in time series.

Syntax :FETCh:ADEMod:AM?

Arguments None

Returns #<Num_digit><Num_byte><Data(1)><Data(2)>...<Data(n)>

Where

<Num_digit> is the number of digits in <Num_byte>.

<Num_byte> is the number of bytes of the data that follow.

<Data(n)> is the percentage modulation data in percent (%) for the point n.

4-byte little endian floating-point format specified in IEEE 488.2

n: Max 512000 (= 1024 points × 500 frames)

Measurement Modes DEMADEM

Examples :FETCh:ADEMod:AM?
might return #41024xxxx... (1024-byte data) for the results of the AM signal analysis.

Related Commands :INSTRument[:SElect]

:FETCh:ADEMod:AM:RESult? (Query Only)

Returns the measurement results of the AM signal analysis.

Syntax :FETCh:ADEMod:AM:RESult?

Arguments None

Returns <+AM>,<-AM>,<Total_AM>

Where

<+AM>::=<NRf> is the positive peak AM value in percent (%).

<-AM>::=<NRf> is the negative peak AM value in percent (%).

<Total_AM>::=<NRf> is the total AM value: (peak-peak AM value) / 2
in percent (%).

Measurement Modes DEMADEM

Examples :FETCh:ADEMod:AM:RESult?
might return 37.34,-48.75,43.04.

Related Commands :INSTrument[:SElect]

:FETCh:ADEMod:FM? (Query Only)

Returns the results of the FM signal analysis in time series.

Syntax :FETCh:ADEMod:FM?

Arguments None

Returns #<Num_digit><Num_byte><Data(1)><Data(2)>...<Data(n)>

Where

<Num_digit> is the number of digits in <Num_byte>.

<Num_byte> is the number of bytes of the data that follow.

<Data(n)> is the frequency shift data in Hz for the point n.

4-byte little endian floating-point format specified in IEEE 488.2

n: Max 512000 (= 1024 points × 500 frames)

Measurement Modes DEMADEM

Examples :FETCh:ADEMod:FM?
might return #41024xxxx... (1024-byte data) for the results of the FM signal analysis.

Related Commands :INSTRument[:SElect]

:FETCh:ADEMod:FM:RESult? (Query Only)

Returns the measurement results of the FM signal analysis.

Syntax :FETCh:ADEMod:FM:RESult?

Arguments None

Returns <+Pk_Freq_Dev>,<-Pk_Freq_Dev>,<P2P_Freq_Dev>,<P2P_Freq_Dev/2>,<RMS_Freq_Dev>

Where

<+Pk_Freq_Dev>::=<NRf> is the positive peak frequency deviation in Hz.

<-Pk_Freq_Dev>::=<NRf> is the negative peak frequency deviation in Hz.

<P2P_Freq_Dev>::=<NRf> is the peak-to-peak frequency deviation in Hz.

<P2P_Freq_Dev/2>::=<NRf> is (peak-to-peak frequency deviation) / 2 in Hz.

<RMS_Freq_Dev>::=<NRf> is the RMS frequency deviation in Hz.

Examples :FETCh:ADEMod:FM:RESult?
might return 1.13e+4,-1.55e+4,2.48e+4,1.24e+4,1.03e+4.

Related Commands :INSTRument[:SElect]

:FETCh:ADEMod:PM? (Query Only)

Returns the results of the PM signal analysis in time series.

Syntax :FETCh:ADEMod:PM?

Arguments None

Returns #<Num_digit><Num_byte><Data(1)><Data(2)>...<Data(n)>

Where

<Num_digit> is the number of digits in <Num_byte>.

<Num_byte> is the number of bytes of the data that follow.

<Data(n)> is the phase shift data in degrees for the point n.

4-byte little endian floating-point format specified in IEEE 488.2

n: Max 512000 (= 1024 points × 500 frames)

Measurement Modes DEMADEM

Examples :FETCh:ADEMod:PM?

might return #41024xxxx... (1024-byte data) for the results of the PM signal analysis.

Related Commands :INSTRument[:SElect]

:FETCh:CCDF? (Query Only)

Returns the CCDF measurement results.

Syntax :FETCh:CCDF?

Arguments None

Returns <meanpower>,<peakpower>,<cfactor>

Where

<meanpower>::=<NRf> is the average power measured value in dBm.

<peakpower>::=<NRf> is the peak power measured value in dBm.

<cfactor>::=<NRf> is the crest factor in dB.

Measurement Modes TIMCCDF

Examples :FETCh:CCDF?
might return -11.16,-8.18,2.96 for the CCDF measurement results.

Related Commands :INSTRument[:SElect]

:FETCh:DDEMod? (Query Only)**Option 21 Only**

Returns the results of the digital modulation analysis.

Syntax :FETCh:DDEMod? { IQVTime | FVTime | CONSte | EVM | AEVM | PEVM
| MERRor | AMERRor | PMERRor | PERRor | APERRor | PPERror | RHO
| SLENgth | FERRor | OOFFset | STABle | PVTTime | AMAM | AMPM
| CCDF | PDF }

Arguments Information queried is listed below for each of the arguments:

Table 2-34: Queried information on the digital modulation analysis results

Argument	Information queried
IQVTime	IQ level versus Time measured value
FVTime	Frequency versus Time measured value (for FSK demodulation only)
CONSte	Constellation measurement results (coordinates data array of symbols)
EVM	Error Vector Magnitude (EVM) measurement results
AEVM	EVM RMS value
PEVM	EVM peak value and its symbol number
MERRor	Amplitude error
AMERRor	Amplitude error RMS value
PMERRor	Amplitude error peak value and its symbol number
PERRor	Phase error
APERRor	Phase error RMS value
PPERror	Phase error peak value and its symbol number
RHO	Value of waveform quality (ρ)
SLENgth	Number of analyzed symbols
FERRor	Frequency error
OOFFset	Origin offset value (Not available when [:SENSe]:DDEMod:FORMat is set to ASK, FSK or GFSK)
STABle	Data from symbol table
PVTTime	Power versus Time (Valid when [:SENSe]:DDEMod:FORMat is set to ASK)
AMAM	AM/AM measurement results
AMPM	AM/PM measurement results

Table 2–34: Queried information on the digital modulation analysis results (Cont.)

Argument	Information queried
CCDF	CCDF measurement results
PDF	PDF measurement results

Returns Returns are listed below for each of the arguments. You can select degrees or radians for the angular unit using the :UNIT:ANGLE command.

IQVTime. #<Num_digit><Num_byte><Idata(1)><Qdata(1)>
<Idata(2)><Qdata2>...<Idata(n)><Qdata(n)>

Where

<Num_digit> is the number of digits in <Num_byte>.

<Num_byte> is the number of bytes of data that follow.

<Idata(n)><Qdata(n)> is the I and Q signal level data in volts.

4-byte little endian floating-point format specified in IEEE 488.2

n: Max 512000 (= 1024 points × 500 frames)

FVTime. #<Num_digit><Num_byte><Data(1)><Data(2)>...<Data(n)>

Where

<Num_digit> is the number of digits in <Num_byte>.

<Num_byte> is the number of bytes of data that follow.

<Data(n)> is the frequency shift data in Hz for the point n.

4-byte little endian floating-point format specified in IEEE 488.2

n: Max 512000 (= 1024 points × 500 frames)

CONSt. #<Num_digit><Num_byte><Ip(1)><Qp(1)>...<Ip(n)><Qp(n)>

Where

<Num_digit> is the number of digits in <Num_byte>.

<Num_byte> is the number of bytes of data that follow.

<Ip(n)> is the sample position on the I axis in a normalized value.

<Qp(n)> is the sample position on the Q axis in a normalized value.

Both <Ip(n)> and <Qp(n)> are in the 4-byte little endian floating-point format specified in IEEE 488.2. n: Max 512000 (= 1024 points × 500 frames)

EVM. #<Num_digit><Num_byte><Evm(1)><Evm(2)>...<Evm(n)>

Where

<Num_digit> is the number of digits in <Num_byte>.

<Num_byte> is the number of bytes of data that follow.

<Evm(n)> is the value of symbol EVM in percent (%).

4-byte little endian floating-point format specified in IEEE 488.2

n: Max 512000 (= 1024 points × 500 frames)

AEVM. <aevm>::=<NRf> is the EVM RMS value in percent (%).

PEVM. <pevm>,<symb>

Where

<pevm>::=<NRf> is the EVM peak value in percent (%).

<symb>::=<NR1> is the symbol number for the EVM peak value.

MERRor. #<Num_digit><Num_byte><Merr(1)><Merr(2)>...<Merr(n)>

Where

<Num_digit> is the number of digits in <Num_byte>.

<Num_byte> is the number of bytes of data that follow.

<Merr(n)> is the value of amplitude error of symbol in percent (%).

4-byte little endian floating-point format specified in IEEE 488.2

n: Max 512000 (= 1024 points × 500 frames)

AMERror. <amer>::=<NRf> is the amplitude error RMS value in percent (%).

PMERror. <pmer>,<symb>

Where

<pmer>::=<NRf> is the amplitude error peak value in percent (%).

<symb>::=<NR1> is the symbol number for the amplitude error peak value.

PERRor. #<Num_digit><Num_byte><Perr(1)><Perr(2)>...<Perr(n)>

Where

<Num_digit> is the number of digits in <Num_byte>.

<Num_byte> is the number of bytes of data that follow.

<Perr(n)> is the value of phase error of symbol in degrees or radians.

4-byte little endian floating-point format specified in IEEE 488.2

n: Max 512000 (= 1024 points × 500 frames)

APERror. <aper>::=<NRf> is the phase error RMS in degrees or radians.

PPERror. <pper>, <symb>

Where

<pper>::=<NRf> is the phase error peak value in degrees or radians.

<symb>::=<NRf> is the symbol number for the phase error peak value.

RHO. <rho>::=<NRf> is the measured value of waveform quality (ρ).

SLENgth. <slen>::=<NR1> is the number of analyzed symbols.

FERRor. <ferr>::=<NRf> is the frequency error in Hz.

OOFFset. <ooff>::=<NRf> is the origin offset in dB.

STABle. #<Num_digit><Num_byte><Sym(1)><Sym(2)>...<Sym(n)>

Where

<Num_digit> is the number of digits in <Num_byte>.

<Num_byte> is the number of bytes of data that follow.

<Sym(n)>::=<NR1> is the symbol data.

n: Max 512000 (= 1024 points \times 500 frames)

PVTime. #<Num_digit><Num_byte><Data(1)><Data(2)>...<Data(n)>

Where

<Num_digit> is the number of digit in <Num_byte>.

<Num_byte> is the number of bytes of data that follow.

<Data(n)> is the time domain power data in dBm.

4-byte little endian floating-point format specified IEEE 488.2.

n: Max 512000 (= 1024 points \times 500 frames)

AMAM. <Comp>, <Coeff_num>{, <Coeff>}

Where

<Comp>::=<NRf> is the 1 dB compression point in dBm.

<Coeff_Num>::=<NR1> is the number of coefficients (1 to 16).

It is equal to the value set using the [:SENSe]:DDEMod:NLINearity:COEFFi-
cient command plus 1.

<Coeff>::=<NRf> is the coefficient value.

AMPM. <Coeff_num>{,<Coeff>}

Where

<Coeff_Num>::=<NR1> is the number of coefficients (1 to 16).

It is equal to the value set using the [:SENSe]:DDEMod:NLINearity:COEFFi-
cient command plus 1.

<Coeff>::=<NRf> is the coefficient value.

CCDF. <Mean_Power_D>,<Peak_Power_D>,<Crest_Factor_D>,
<Mean_Power_R>,<Peak_Power_R>,<Crest_Factor_R>

Where

<Mean_Power_D>::=<NRf> is the measured average power in dBm.

<Peak_Power_D>::=<NRf> is the measured peak power in dBm.

<Crest_Factor_D>::=<NRf> is the measured crest factor in dB.

<Mean_Power_R>::=<NRf> is the reference average power in dBm.

<Peak_Power_R>::=<NRf> is the reference peak power in dBm.

<Crest_Factor_R>::=<NRf> is the reference crest factor in dB.

PDF. <Mean_Power_D>,<Peak_Power_D>,<Mean_Power_R>,<Peak_Power_R>

Where

<Mean_Power_D>::=<NRf> is the measured average power in dBm.

<Peak_Power_D>::=<NRf> is the measured peak power in dBm.

<Mean_Power_R>::=<NRf> is the reference average power in dBm.

<Peak_Power_R>::=<NRf> is the reference peak power in dBm.

Measurement Modes

DEMDDEM

Examples

:FETCh:DDEMod? IQVTime

might return #41024xxxx... (1024-byte data) for the IQ level versus time
measurement results.

Related Commands

:INSTrument[:SElect], [:SENSe]:DDEMod:FORMat, :UNIT:ANGLE

:FETCh:DISTRibution:CCDF? (Query Only)

Returns the CCDF trace data in the CCDF measurement.

Syntax :FETCh:DISTRibution:CCDF?

Arguments None

Returns #<Num_digit><Num_byte><Data(1)><Data(2)>...<Data(n)>

Where

<Num_digit> is the number of digits in <Num_byte>.

<Num_byte> is the number of bytes of the data that follow.

<Data(n)> is the phase shift data in degrees for the point n.

4-byte little endian floating-point format specified in IEEE 488.2

n: Max 10001

Invalid data is returned as -1000.

Measurement Modes TIMCCDF

Examples :FETCh:DISTRibution:CCDF?
might return #41024xxxx... (1024-byte data) for the CCDF trace data in the CCDF measurement.

Related Commands :FETCh:CCDF?, :INSTrument[:SElect]

:FETCh:OVlew? (Query Only)

Returns the minimum and maximum values for each 1024-point segment of waveform data displayed on the overview in the Demod (modulation analysis) and the Time (time analysis) modes.

NOTE. The :CONFigure:OVlew command must be run to turn measurement off before the :FETCh:OVlew command is executed.

Syntax :FETCh:OVlew?

Returns #<Num_digit><Num_byte><MinData(1)><MaxData(1)>...
<MinData(n)><MaxData(n)>

Where

<Num_digit> is the number of digits in <Num_byte>.

<Num_byte> is the number of bytes of the data that follow.

<MinData(n)> is the minimum data in dBm for each 1024 data point segment.

4-byte little endian floating-point format specified in IEEE 488.2

<MaxData(n)> is the maximum data in dBm for each 1024 data point segment.

4-byte little endian floating-point format specified in IEEE 488.2

n: Max 16000 (standard) / 64000 (Option 02)

Measurement Modes DEMADEM, TIMCCDF, TIMTRAN, TIMPULSE

Examples :FETCh:OVlew?
might return #510240xxx... (10240-byte data) representing the minimum and the maximum values of waveform displayed on the overview.

Related Commands :CONFigure:OVlew, :INSTRument[:SElect]

:FETCh:PULSe? (Query Only)

Returns the result of the pulse characteristics analysis.

Syntax :FETCh:PULSe? { ALL | WIDTH | PPOWer | OORatio | RIPPlE | PERiod
| DCYClE | PHASe | CHPower | OBWidth | EBWidth | FREQuency }

Arguments Information queried is listed below for each of the arguments:

Table 2–35: Queried information

Argument	Information queried
ALL	All
WIDTH	Pulse width
PPOWer	Maximum (peak) power in the pulse on-time
OORatio	Difference between the on-time power and off-time power
RIPPlE	Difference between the maximum and the minimum power in the on-time
PERiod	Time between the pulse rising edge and the next rising edge
DCYClE	Ratio of the pulse width to the pulse repetition interval (PRI)
PHASe	Phase at a certain point of each pulse
CHPower	Channel power of the pulse on-time spectrum
OBWidth	OBW (Occupied Bandwidth) of the pulse on-time spectrum
EBWidth	EBW (Emission Bandwidth) of the pulse on-time spectrum
FREQuency	Frequency deviation in the pulse on-time

Returns Returns are listed below for each of the arguments.

ALL. <width>,<ppower>,<ooratio>,<ripple>,<period>,<dcycle>,<phase>,<chp>,<obw>,<ebw>,<freq>

Where

<width>::=<NRf> is the pulse width in s.
 <ppower>::=<NRf> is the peak power in watts.
 <ooratio>::=<NRf> is the on/off ratio in dB.
 <ripple>::=<NRf> is the pulse ripple in watts.
 <period>::=<NRf> is the pulse repetition interval in s.
 <dcycle>::=<NRf> is the duty cycle in percent (%).
 <phase>::=<NRf> is the pulse-pulse phase in degrees.
 <chp>::=<NRf> is the channel power in watts.
 <obw>::=<NRf> is the OBW in Hz.
 <ebw>::=<NRf> is the EBW in Hz.
 <freq>::=<NRf> is the frequency deviation in Hz.

WIDTH. #<Num_digit><Num_byte><Width(1)><Width(2)>...<Width(n)>

Where

<Num_digit> is the number of digits in <Num_byte>.
 <Num_byte> is the number of bytes of data that follow.
 <Width(n)> is the pulse width value for each pulse number.
 4-byte little endian floating-point format specified in IEEE 488.2
 n: Max 1000

PPOWER. #<Num_digit><Num_byte><Ppower(1)><Ppower(2)>...<Ppower(n)>

Where

<Num_digit> is the number of digits in <Num_byte>.
 <Num_byte> is the number of bytes of data that follow.
 <Power(n)> is the peak power value for each pulse number.
 4-byte little endian floating-point format specified in IEEE 488.2
 n: Max 1000

OORatio. #<Num_digit><Num_byte><Ooratio(1)><Ooratio(2)>...<Ooratio(n)>

Where

<Num_digit> is the number of digits in <Num_byte>.
 <Num_byte> is the number of bytes of data that follow.
 <Ooratio(n)> is the on/off ratio value for each pulse number.
 4-byte little endian floating-point format specified in IEEE 488.2
 n: Max 1000

RIPlle. #<Num_digit><Num_byte><Ripple(1)><Ripple(2)>...<Ripple(n)>

Where

<Num_digit> is the number of digits in <Num_byte>.

<Num_byte> is the number of bytes of data that follow.

<Ripple(n)> is the ripple value for each pulse number.

4-byte little endian floating-point format specified in IEEE 488.2

n: Max 1000

PERiod. #<Num_digit><Num_byte><Period(1)><Period(2)>...<Period(n)>

Where

<Num_digit> is the number of digits in <Num_byte>.

<Num_byte> is the number of bytes of data that follow.

<Period(n)> is the pulse repetition interval value for each pulse number.

4-byte little endian floating-point format specified in IEEE 488.2

n: Max 1000

DCYClE. #<Num_digit><Num_byte><Dcycle(1)><Dcycle(2)>...<Dcycle(n)>

Where

<Num_digit> is the number of digits in <Num_byte>.

<Num_byte> is the number of bytes of data that follow.

<Dcycle(n)> is the duty value for each pulse number.

4-byte little endian floating-point format specified in IEEE 488.2

n: Max 1000

PHASe. #<Num_digit><Num_byte><Phase(1)><Phase(2)>...<Phase(n)>

Where

<Num_digit> is the number of digits in <Num_byte>.

<Num_byte> is the number of bytes of data that follow.

<Phase(n)> is the pulse-pulse phase value for each pulse number.

4-byte little endian floating-point format specified in IEEE 488.2

n: Max 1000

CHPower. #<Num_digit><Num_byte><Chp(1)><Chp(2)>...<Chp(n)>

Where

<Num_digit> is the number of digits in <Num_byte>.

<Num_byte> is the number of bytes of data that follow.

<Chp(n)> is the Channel Power value for each pulse number.

4-byte little endian floating-point format specified in IEEE 488.2

n: Max 1000

OBWidth. #<Num_digit><Num_byte><Obw(1)><Obw(2)>...<Obw(n)>

Where

<Num_digit> is the number of digits in <Num_byte>.

<Num_byte> is the number of bytes of data that follow.

<Obw(n)> is the OBW value for each pulse number.

4-byte little endian floating-point format specified in IEEE 488.2

n: Max 1000

EBWidth. #<Num_digit><Num_byte><Ebw(1)><Ebw(2)>...<Ebw(n)>

Where

<Num_digit> is the number of digits in <Num_byte>.

<Num_byte> is the number of bytes of data that follow.

<Ebw(n)> is the EBW value for each pulse number.

4-byte little endian floating-point format specified in IEEE 488.2

n: Max 1000

FREquency. #<Num_digit><Num_byte><Freq(1)><Freq(2)>...<Freq(n)>

Where

<Num_digit> is the number of digits in <Num_byte>.

<Num_byte> is the number of bytes of data that follow.

<Freq(n)> is the frequency deviation value for each pulse number.

4-byte little endian floating-point format specified in IEEE 488.2

n: Max 1000

Measurement Modes

TIMPULSE

Examples

:FETCh:PULSe? WIDTh

might return #3500xxxx... (500-byte data) for the pulse width measurement result.

Related Commands

:INSTRument[:SElect]

:FETCh:PULSe:SPECTrum? (Query Only)

Returns the spectrum data of the frequency domain measurement in the pulse characteristics analysis.

This query command is valid when :DISPlay:PULSe:SView:FORMat is set to CHPowr, OBWidth, or EBWidth.

Syntax :FETCh:PULSe:SPECTrum?

Arguments None

Returns #<Num_digit><Num_byte><Data(1)><Data(2)>...<Data(n)>

Where

<Num_digit> is the number of digits in <Num_byte>.

<Num_byte> is the number of bytes of data that follow.

<Data(n)> is the spectrum in dBm.

4-byte little endian floating-point format specified IEEE 488.2.

n: Max 240001

Measurement Modes TIMPULSE

Examples :FETCh:PULSe:SPECTrum?
might return #43200xxxx... (3200-byte data) for the spectrum data.

Related Commands :DISPlay:PULSe:SView:FORMat, :INSTrument[:SElect]

:FETCh:PULSe:TAMPlitude? (Query Only)

Returns the time domain amplitude data of the time domain measurement in the pulse characteristics analysis.

This query command is valid when :DISPlay:PULSe:SVIew:FORMat is set to WIDTh, PPOWer, OORatio, RIPPlE, PERiod, DCYClE, or PHASe.

Syntax :FETCh:PULSe:TAMPlitude?

Arguments None

Returns #<Num_digit><Num_byte><Data(1)><Data(2)>...<Data(n)>

Where

<Num_digit> is the number of digits in <Num_byte>.

<Num_byte> is the number of bytes of data that follow.

<Data(n)> is the absolute power for each data in watts.

4-byte little endian floating-point format specified IEEE 488.2.

n: Max 262,144

Measurement Modes TIMPULSE

Examples :FETCh:PULSe:TAMPlitude?
might return #43200xxxx... (3200-byte data) for the time domain amplitude.

Related Commands :DISPlay:PULSe:SVIew:FORMat, :INSTrument[:SElect]

:FETCh:PULSe:TFRequency? (Query Only)

Returns the frequency deviation measurement results in the pulse characteristics analysis.

This query command is valid when :DISPlay:PULSe:SVIew:FORMat is set to FREQuency.

Syntax :FETCh:PULSe:TFRequency?

Arguments None

Returns #<Num_digit><Num_byte><Data(1)><Data(2)>...<Data(n)>

Where

<Num_digit> is the number of digits in <Num_byte>.

<Num_byte> is the number of bytes of data that follow.

<Data(n)> is the frequency deviation value in Hz on the time axis.

4-byte little endian floating-point format specified IEEE 488.2.

n: Max 262,144

Measurement Modes TIMPULSE

Examples :FETCh:PULSe:TFRequency?
might return #43200xxxx... (3200-byte data) for the time domain frequency.

Related Commands :DISPlay:PULSe:SVIew:FORMat, :INSTrument[:SElect]

:FETCh:SPECTrum? (Query Only)

Returns spectrum waveform data in the S/A (spectrum analysis) mode.

Syntax :FETCh:SPECTrum?

Arguments None

Returns #<Num_digit><Num_byte><Data(1)><Data(2)>...<Data(n)>

Where

<Num_digit> is the number of digits in <Num_byte>.

<Num_byte> is the number of bytes of the data that follow.

<Data(n)> is the amplitude spectrum in dBm.

4-byte little endian floating-point format specified in IEEE 488.2

n: Max 400000 (= 800 points × 500 frames)

Measurement Modes SANORMAL, SASGRAM, SARTIME

Examples :FETCh:SPECTrum?
might return #43200xxxx... (3200-byte data) for the spectrum waveform data.

Related Commands :INSTrument[:SElect]

:FETCh:SPECTrum:ACPower? (Query Only)

Returns the results of adjacent channel leakage power ratio (ACPR) measurement in the S/A (spectrum analysis) mode.

Syntax :FETCh:SPECTrum:ACPower?

Arguments None

Returns <chpower>,<acpm1>,<acpp1>,<acpm2>,<acpp2>,<acpm3>,<acpp3>

Where

<chpower>::=<NRf> is the channel power measured value in dBm.

<acpm1>::=<NRf> is the first lower adjacent channel ACPR in dB.

<acpp1>::=<NRf> is the first upper adjacent channel ACPR in dB.

<acpm2>::=<NRf> is the second lower adjacent channel ACPR in dB.

<acpp2>::=<NRf> is the second upper adjacent channel ACPR in dB.

<acpm3>::=<NRf> is the third lower adjacent channel ACPR in dB.

<acpp3>::=<NRf> is the third upper adjacent channel ACPR in dB.

NOTE. All the values may not be returned when the adjacent channel(s) goes out of the span due to the settings of the channel bandwidth and spacing (refer to the [:SENSe]:ACPower subgroup). For example, if the third adjacent channel goes out of the span, the response is <chpower>,<acpm1>,<acpp1>,<acpm2>,<acpp2>; <acpm3> and <acpp3> are not returned.

Measurement Modes SANORMAL, SASGRAM, SARTIME

Examples :FETCh:SPECTrum:ACPower?
might return -11.38,-59.41,-59.51,-59.18,-59.31,-59.17,-59.74 for the ACPR measurement results.

Related Commands :INSTrument[:SElect], [:SENSe]:ACPower subgroup

:FETCh:SPECTrum:CFrequency? (Query Only)

Returns the results of the carrier frequency measurement in the S/A (spectrum analysis) mode.

Syntax :FETCh:SPECTrum:CFrequency?

Arguments None

Returns <cfreq>::=<NRf> is the measured value of carrier frequency in Hz.

Measurement Modes SANORMAL, SASGRAM, SARTIME

Examples :FETCh:SPECTrum:CFrequency?
might return 846187328.5 for the carrier frequency.

Related Commands :INSTRument[:SElect]

:FETCh:SPECTrum:CHPower? (Query Only)

Returns the results of the channel power measurement in the S/A (spectrum analysis) mode.

Syntax :FETCh:SPECTrum:CHPower?

Arguments None

Returns <chpower>::=<NRf> is the channel power measured value in dBm.

Measurement Modes SANORMAL, SASGRAM, SARTIME

Examples :FETCh:SPECTrum:CHPower?
might return -1.081 for the measurement results of channel power.

Related Commands :INSTRument[:SElect]

:FETCh:SPECTrum:CNRatio? (Query Only)

Returns the results of the carrier-to-noise ratio (C/N) measurement in the S/A (spectrum analysis) mode.

Syntax :FETCh:SPECTrum:CNRatio?

Arguments None

Returns <ctn>,<ctno>

Where

<ctn>::=<NRf> is the measured value of C/N in dB.

<ctno>::=<NRf> is the measured value of C/No in dB/Hz.

Measurement Modes SANORMAL, SASGRAM, SARTIME

Examples :FETCh:SPECTrum:CNRatio?
might return 75.594,125.594 for the C/N measurement results.

Related Commands :INSTrument[:SElect]

:FETCh:SPECTrum:EBWidth? (Query Only)

Returns the results of the emission bandwidth (EBW) measurement in the S/A (spectrum analysis) mode.

Syntax :FETCh:SPECTrum:EBWidth?

Arguments None

Returns <ebw>::=<NRf> is the measured value of EBW in Hz.

Measurement Modes SANORMAL, SASGRAM, SARTIME

Examples :FETCh:SPECTrum:EBWidth?
might return 30956.26 for the EBW measurement results.

Related Commands :INSTrument[:SElect]

:FETCh:SPECTrum:OBWidth? (Query Only)

Returns the results of the occupied bandwidth (OBW) measurement in the S/A (spectrum analysis) mode.

Syntax :FETCh:SPECTrum:OBWidth?

Arguments None

Returns <obw>::=<NRf> is the measured value of OBW in Hz.

Measurement Modes SANORMAL, SASGRAM, SARTIME

Examples :FETCh:SPECTrum:OBWidth?
might return 26510.163 for the OBW measurement results.

Related Commands :INSTrument[:SElect]

:FETCh:SPECTrum:SPURious? (Query Only)

Returns the results of the spurious signal measurement in the S/A (spectrum analysis) mode.

Syntax :FETCh:SPECTrum:SPURious?

Arguments None

Returns <snum>{,<dfreq>,<rdb>}

Where

<snum>::=<NR1> is the number of detected spurious emissions, max. 20

<dfreq>::=<NRf> is the detuned frequency of spurious relative to carrier in Hz.

<rdb>::=<NRf> is the spurious signal level relative to carrier in dB.

Measurement Modes SANORMAL, SASGRAM, SARTIME

Examples :FETCh:SPECTrum:SPURious?
might return 3,1.2E6,-79,2.4E6,-79.59,1E6,-80.38 for the spurious signal measurement.

Related Commands :INSTRument[:SElect]

:FETCh:TRANSient:FVTime? (Query Only)

Returns the results of the frequency vs. time measurement in the Time (time analysis) mode.

Syntax :FETCh:TRANSient:FVTime?

Arguments None

Returns #<Num_digit><Num_byte><Data(1)><Data(2)>...<Data(n)>

Where

<Num_digit> is the number of digits in <Num_byte>.

<Num_byte> is the number of bytes of the data that follow.

<Data(n)> is the frequency data in Hz for the point n.

4-byte little endian floating-point format specified in IEEE 488.2

n: Max 512000 (= 1024 points × 500 frames)

Measurement Modes TIMTRAN

Examples :FETCh:TRANSient:FVTime?
might return #41024xxxx... (1024-byte data) for the results of the frequency vs. time measurement.

Related Commands :INSTrument[:SElect]

:FETCh:TRANSient:IQVTime? (Query Only)

Returns the results of the IQ level vs. time measurement in the Time (time analysis) mode.

Syntax :FETCh:TRANSient:IQVTime?

Arguments None

Returns #<Num_digit><Num_byte><Idata(1)><Qdata(1)>
<Idata(2)><Qdata2>...<Idata(n)><Qdata(n)>

Where

<Num_digit> is the number of digits in <Num_byte>.

<Num_byte> is the number of bytes of the data that follow.

<Idata(n)><Qdata(n)> is the I and Q signal level data in volts for the point n.

4-byte little endian floating-point format specified in IEEE 488.2

n: Max 512000 (= 1024 points x 500 frames)

Measurement Modes TIMTRAN

Examples :FETCh:TRANSient:IQVTime?
might return #41024xxxx... (1024-byte data) for the results of the IQ level vs. time measurement.

Related Commands :INSTrument[:SElect]

:FETCh:TRANSient:PVTime? (Query Only)

Returns the results of the power vs. time measurement in the Time (time analysis) mode.

Syntax :FETCh:TRANSient:PVTime?

Arguments None

Returns #<Num_digit><Num_byte><Data(1)><Data(2)>...<Data(n)>

Where

<Num_digit> is the number of digits in <Num_byte>.

<Num_byte> is the number of bytes of the data that follow.

<Data(n)> is the time domain power data in dBm.

4-byte little endian floating-point format specified in IEEE 488.2

n: Max 512000 (= 1024 points × 500 frames)

Measurement Modes TIMTRAN

Examples :FETCh:TRANSient:PVTime?
might return #41024xxxx... (1024-byte data) for the results of the power vs. time measurement.

Related Commands :INSTrument[:SElect]

:FORMat Commands

The FORMat commands define the data output format.

Command Tree

Header	Parameter
:FORMat	
:BORDER	NORMa1 SWAPped
[:DATA]	REAL,32 REAL,64

:FORMat:BORDER (?)

Sets or queries the byte order for transferring binary data.

Syntax :FORMat:BORDER { NORMa1 | SWAPped }
 :FORMat:BORDER?

Arguments NORMa1 selects the normal byte order.
 SWAPped swaps the byte order.

Measurement Modes All

Examples :FORMat:BORDER SWAPped
 swaps the byte order for data output.

:FORMat[:DATA] (?)

Selects or queries the output data format.

Syntax :FORMat[:DATA] { REAL,32 | REAL,64 }
 :FORMat[:DATA]?

Arguments REAL,32 specifies the 32-bit floating point format.
 REAL,64 specifies the 64-bit floating point format.

Measurement Modes All

Examples :FORMat:DATA REAL,32
 specifies the 32-bit floating point format for data output.

:HCOPY Commands

The :HCOPY commands control screen hardcopy.

Command Tree

Header	Parameter
:HCOPY	
:BACKground	BLACK WHITE
:DESTination	PRINter MMEMory
[:IMMediate]	

:HCOPY:BACKground (?)

Selects or queries the hardcopy background color.

Syntax :HCOPY:BACKground { BLACK | WHITE }
:HCOPY:BACKground?

Arguments BLACK outputs the screen image in the black background, without reversing it.
WHITE reverses the screen image to output it in the white background.

Measurement Modes All

Examples :HCOPY:BACKground WHITE
reverses the screen image to output it in the white background.

:HCOPY:DESTination (?)

Selects or queries the hardcopy output destination (printer or file).

Syntax :HCOPY:DESTination { PRINter | MMEMory }
:HCOPY:DESTination?

Arguments PRINter specifies that the hardcopy is output to the preset printer, which is the one that has been set as the printer to be used usually under Windows. For using the printer, refer to the *RSA3303A and RSA3308A User Manual*.

MMEMory specifies that the hardcopy is output to the bitmap file specified with the :MMEMory:NAME command.

Measurement Modes All

Examples :HCOPY:DESTination PRINter
specifies that the hardcopy is output to the preset printer.

Related Commands :HCOPY[:IMMediate], :MMEMory:NAME

:HCOPY[:IMMEDIATE] (No Query Form)

Outputs the screen hardcopy to the destination selected with the :HCOPY:DESTINATION command.

Syntax :HCOPY[:IMMEDIATE]

Arguments None

Measurement Modes All

Examples :HCOPY:IMMEDIATE
outputs the screen hardcopy.

Related Commands :HCOPY:DESTINATION

:INITiate Commands

The :INITiate commands control data acquisition.

Command Tree

Header	Parameter
:INITiate	
:CONTinuous	<boolean>
[:IMMediate]	
:REStart	

:INITiate:CONTInuous (?)

Determines whether to use the continuous mode to acquire the input signal.

Syntax :INITiate:CONTInuous { OFF | ON | 0 | 1 }
 :INITiate:CONTInuous?

Arguments OFF or 0 specifies that the single mode, rather than the continuous mode, is used for data acquisition. To initiate the acquisition, use the :INITiate[:IMMEDIATE], described below.

To stop the acquisition because the trigger is not generated in single mode, send the following command:

```
:INITiate:CONTInuous OFF
```

ON or 1 initiates data acquisition in the continuous mode.

To stop the acquisition in the continuous mode, send the following command:

```
:INITiate:CONTInuous OFF
```

NOTE. When the analyzer receives a :FETCh command while operating in the continuous mode, it returns an execution error. If you want to run a :FETCh, use the :INITiate[:IMMEDIATE] command.

Measurement Modes All

Examples :INITiate:CONTInuous ON
 specifies that the continuous mode is used to acquire the input signal.

Related Commands :FETCh commands, :INITiate[:IMMEDIATE]

:INITiate[:IMMediate] (No Query Form)

Starts input signal acquisition.

Syntax :INITiate[:IMMediate]

Arguments None

Measurement Modes All

Examples :INITiate:IMMediate
Starts input signal acquisition.

Related Commands :INITiate:CONTinuous

:INITiate:REStart (No Query Form)

Reruns input signal acquisition. In the single mode, this command is equivalent to the :INITiate[:IMMediate] command. In the continuous mode, this command is equivalent to the :ABORt command.

Syntax :INITiate:REStart

Arguments None

Measurement Modes All

Examples :INITiate:REStart
reruns input signal acquisition.

Related Commands :ABORt, :INITiate[:IMMediate]

:INPut Commands

The :INPut commands control the characteristics of the signal input.

Command Tree

Header	Parameter
:INPut	
:ALEVel	
:ATTenuation	<numeric_value>
:AUTO	<boolean>
:COUPling	AC DC (Option 03 only)
:MIXer	<numeric_value>
:MLEVel	<numeric_value>

:INPut:ALEVel (No Query Form)

Adjusts amplitude automatically for the best system performance using the input signal as a guide.

Syntax :INPut:ALEVel

Arguments None

Measurement Modes All

Examples :INPut:ALEVel
adjusts amplitude automatically.

:INPut:ATTenuation (?)

When you have selected OFF or 0 in the :INPut:ATTenuation:AUTO command, described below, use this command to set the input attenuation. The query version of this command returns the input attenuation setting.

Syntax :INPut:ATTenuation <rel_amp1>
:INPut:ATTenuation?

Arguments <rel_amp1>::=<NR1> specifies the input attenuation. The valid settings depend on the measurement frequency band as shown in Table 2–36.

Table 2–36: Input attenuation settings

Measurement frequency band	Setting
RF (RSA3303A) / RF1 (RSA3308A)	0 to 50 dB (in 2 dB steps)
RF2, RF3 (RSA3308A)	0 to 50 dB (in 10 dB steps)

Measurement Modes All

Examples :INPut:ATTenuation 20
sets the input attenuation to 20 dB.

Related Commands :INPut:ATTenuation:AUTO

:INPut:ATTenuation:AUTO (?)

Determines whether to automatically set the input attenuation according to the reference level.

Syntax :INPut:ATTenuation:AUTO { OFF | ON | 0 | 1 }
:INPut:ATTenuation:AUTO?

Arguments OFF or 0 specifies that the input attenuation is not set automatically. To set it, use the :INPut:ATTenuation command, described above.

ON or 1 specifies that the input attenuation is set automatically.

Measurement Modes All

Examples :INPut:ATTenuation:AUTO ON
specifies that the input attenuation is set automatically.

Related Commands :INPut:ATTenuation

:INPut:COUPling (?)

Option 03 Only

Selects or queries the input coupling in the IQ input mode. This command is valid when IQ (IQ input) is selected with the [:SENSe]:FEED command.

Syntax :INPut:COUPling { AC | DC }
 :INPut:COUPling?

Arguments AC selects the AC coupling.
 DC selects the DC coupling.

Measurement Modes All

Examples :INPut:COUPling AC
 selects the AC coupling in the IQ input mode.

Related Commands [:SENSe]:FEED

:INPut:MIXer (?)

Selects or queries the mixer level.

NOTE. To set the mixer level, you must have selected On in the :INPut:ATTenuation:AUTO command.

Syntax :INPut:MIXer <amp1>
:INPut:MIXer?

Arguments <amp1>::=<NR1> specifies the mixer level. The valid settings depend on the measurement frequency band as shown in Table 2–37.

Table 2–37: Mixer level settings

Measurement frequency band	Setting (dBm)
RF (RSA3303A) / RF1 (RSA3308A)	-5, -10, -15, -20, or -25
RF2, RF3 (RSA3308A)	-5, -15, or -25

Measurement Modes All

Examples :INPut:MIXer -20
sets the mixer level to -20 dBm.

Related Commands :INPut:ATTenuation:AUTO

:INPut:MLEVel (?)

Sets or queries the reference level. Using this command to set the reference level is equivalent to pressing the **AMPLITUDE** key and then the **Ref Level** side key on the front panel.

Syntax :INPut:MLEVel <ampl>
 :INPut:MLEVel?

Arguments <ampl>::=<NR1> specifies the reference level. The valid settings depend on the measurement frequency band as shown in Table 2–38.

Table 2–38: Reference level range

Measurement frequency band	Setting
Baseband	–30 to +20 dBm (in 2 dB steps)
RF (RSA3303A) / RF1 (RSA3308A)	–51 to +30 dBm (in 1 dB steps)
RF2, RF3 (RSA3308A)	–50 to +30 dBm (in 1 dB steps)
IQ (Option 03 only)	–10 to +20 dBm (in 10 dB steps)

Measurement Modes All

Examples :INPut:MLEVel –10
 sets the reference level to –10 dBm.

:INSTrument Commands

The :INSTrument commands set the measurement mode. Before you can start a measurement, you must set the mode appropriate for the measurement using these commands.

Command Tree

Header	Parameter
:INSTrument	
:CATalog?	
[:SElect]	<mode_name>

:INSTRUMENT:CATalog? (Query Only)

Queries all the measurement modes incorporated in the analyzer.

Syntax :INSTRUMENT:CATalog?

Arguments None

Returns <string> contains the measurement mode names available in the analyzer returned as comma-separated character strings. The following table lists the mode names and their meanings:

Table 2-39: Measurement mode

Mnemonic	Meaning
SANORMAL	Normal spectrum analysis
SASGRAM	Spectrum analysis with spectrogram
SARTIME	Real-time spectrum analysis
DEMADEM	Analog modulation analysis
DEMDEM	Digital modulation analysis (Option 21 only)
TIMCCDF	CCDF analysis
TIMTRAN	Time characteristic analysis
TIMPULSE	Pulse characteristics analysis

In the full options case, all the above mode names are returned as comma-separated character strings.

Measurement Modes All

Examples :INSTRUMENT:CATalog?
might return "SANORMAL", "SASGRAM", "SARTIME", "DEMADEM", "TIMCCDF", "TIMTRAN" for all the measurement modes that the analyzer has.

:INSTrument[:SElect] (?)

Selects or queries the measurement mode.

This command is not affected by *RST.

NOTE. *If you want to change the measurement mode, stop the data acquisition with the :INITiate:CONTinuous OFF command.*

Syntax :INSTrument[:SElect] { SANORMAL | SASGRAM | SARTIME | DEMADEM
 | DEMDDEM | TIMCCDF | TIMTRAN | TIMPULSE }

 :INSTrument[:SElect]?

Arguments <string>

 For details of the modes, refer to Table 2–39 on the previous page.

Examples :INSTrument:SElect "DEMADEM"
 places the analyzer in the analog modulation analysis mode.

Related Commands :CONFigure, :INITiate:CONTinuous

:MMEMory Commands

The :MMEMory commands allow you to manipulate files on the hard disk or floppy disk.

For details on file manipulation, refer to the *RSA3303A and RSA3308A User Manual*.

Command Tree

Header	Parameter
:MMEMory	
:COPI	<file_name1>,<file_name2>
:DELe	<file_name>
:LOAD	
:CORRection	<file_name>
:IQT	<file_name>
:STATe	<file_name>
:TRACe	<file_name>
:NAME	<file_name>
:STORe	
:CORRection	<file_name>
:IQT	<file_name>
:PULSe	<file_name>
:STABle	<file_name> (Option 21 only)
:STATe	<file_name>
:TRACe	<file_name>

NOTE. Use the absolute path to specify the file name. For example, suppose that data file *Sample1.iqt* is located in the *My Documents* folder of Windows. You can specify it as “*C:\My Documents\Sample1.iqt.*”

:MMEMory:COpy (No Query Form)

Copies the contents of a file to another.

Syntax :MMEMory:COpy <file_name1>,<file_name2>

Arguments <file_name1>::=<string> specifies the source file.
<file_name2>::=<string> specifies the destination file.

Measurement Modes All

Examples :MMEMory:COpy "C:\My Documents\File1","C:\My Documents\File2"
copies the contents of File1, located in the My Documents folder, to File2.

:MMEMory:DElete (No Query Form)

Deletes the specified file.

Syntax :MMEMory:DElete <file_name>

Arguments <file_name>::=<string> specifies the file to be deleted.

Measurement Modes All

Examples :MMEMory:DElete "C:\My Documents\File1"
deletes File1 located in the My Documents folder.

:MMEMory:LOAD:CORRection (No Query Form)

Loads the amplitude correction file.

Syntax :MMEMory:LOAD:CORRection <file_name>

Arguments <file_name>::=<string> specifies the file that contains the amplitude correction table. The file extension is .cor.

Measurement Modes SANORMAL, SASGRAM

Examples :MMEMory:LOAD:CORRection "C:\My Documents\File1.cor"
loads the correction table from File1.cor in the My Documents folder.

:MMEMory:LOAD:IQT (No Query Form)

Loads IQ data in time domain from the specified file.

Syntax :MMEMory:LOAD:IQT <file_name>

Arguments <file_name>::=<string> specifies the file from which to load IQ data. The file extension is .iqt.

Measurement Modes SARTIME, DEMADEM, TIMCCDF, TIMTRAN

Examples :MMEMory:LOAD:IQT "C:\My Documents\Data1.iqt"
loads IQ data from the file Data1.iqt in the My Documents folder.

:MMEMory:LOAD:STATe (No Query Form)

Loads settings from the specified file.

Syntax :MMEMory:LOAD:STATe <file_name>

Arguments <file_name>::=<string> specifies the file from which to load settings.
The file extension is .cfg.

Measurement Modes All

Examples :MMEMory:LOAD:STATe "C:\My Documents\Setup1.cfg"
loads settings from the file Setup1.cfg in the My Documents folder.

:MMEMory:LOAD:TRACe<x> (No Query Form)

Loads Trace 1 or 2 waveform data from the specified file.

Syntax :MMEMory:LOAD:TRACe<x> <file_name>

Arguments <file_name>::=<string> specifies the file from which to load trace data.
The file extension is .trc.

Measurement Modes SANORMAL, SASGRAM

Examples :MMEMory:LOAD:TRACe "C:\My Documents\Trace1.trc"
loads Trace 1 data from the file Trace1.trc in the My Documents folder.

Related Commands :MMEMory:STORe:TRACe<x>

:MMEMory:NAME (?)

Specifies or queries the file name when the hardcopy output destination is a file. To select the hardcopy output destination, use the :HCOPY:DESTINATION command.

Syntax :MMEMory:NAME <file_name>
:MMEMory:NAME?

Arguments <file_name>::=<string> specifies the name of the destination file. The file extension .bmp is added automatically.

Measurement Modes All

Examples :MMEMory:NAME "C:\My Documents\Screen1.bmp"
specifies Screen1.bmp in the My Documents folder as the destination file.

Related Commands :HCOPY:DESTINATION

:MMEMory:STORE:CORREction (No Query Form)

Stores the amplitude correction table in the specified file.

Syntax :MMEMory:STORE:CORREction <file_name>

Arguments <file_name>::=<string> specifies the file name. The file extension is .cor.

Measurement Modes SANORMAL, SASGRAM

Examples :MMEMory:STORE:CORREction "C:\My Documents\Sample1.cor"
stores the amplitude correction table in the file Sample1.cor in the My Documents folder.

:MMEMory:STORe:IQT (No Query Form)

Stores IQ data in time domain in the specified file.

Syntax :MMEMory:STORe:IQT <file_name>

Arguments <file_name>::=<string> specifies the file in which to store IQ data. The file extension is .iqt.

Measurement Modes SARTIME, DEMADEM, TIMCCDF, TIMTRAN, TIMPULSE

Examples :MMEMory:STORe:IQT "C:\My Documents\Data1.iqt"
stores IQ data in the file Data1.iqt in the My Documents folder.

:MMEMory:STORe:PULSe (No Query Form)

Stores the pulse measurement results in the specified file.

Syntax :MMEMory:STORe:PULSe <file_name>

Arguments <file_name>::=<string> specifies the file to store the pulse measurement results. The file extension is .csv.

Measurement Modes TIMPULSE

Examples :MMEMory:STORe:PULSe "C:\My Documents\Result1.csv"
stores the pulse measurement results in the Result1.csv file in the My Documents folder.

:MMEMory:STORe:STABle (No Query Form)

Option 21 Only

Stores the symbol table in the specified file.

Syntax :MMEMory:STORe:STABle <file_name>

Arguments <file_name>::=<string> specifies the file in which to store. The file is in text format, and its extension is .sym.

The following are written in the header before the data:

1. Date and time
- 2..Modulation
3. Symbol rate
4. Measurement filter
5. Reference filter
6. Filter factor (α)
7. Time from the data end point of the first symbol

Measurement Modes DEMDDEM

Examples :MMEMory:STORe:STABle "C:\My Documents\Data1.sym"
stores symbol table in the file Data1.sym in the My Documents folder.

:MMEMory:STORe:STATe (No Query Form)

Stores the current settings in the specified file.

Syntax :MMEMory:STORe:STATe <file_name>

Arguments <file_name>::=<string> specifies the file in which to store the current settings. The file extension is .cfg.

Measurement Modes All

Examples :MMEMory:STORe:STATe "C:\My Documents\Setup1.cfg"
stores the current settings the file Setup1.cfg in the My Documents folder.

:MMEMory:STORe:TRACe<x> (No Query Form)

Stores Trace 1 or 2 waveform data in the specified file.

Syntax :MMEMory:STORe:TRACe<x> <file_name>

Arguments <file_name> specifies the file in which to store trace data. The file extension is .trc.

Measurement Modes SANORMAL, SASGRAM

Examples :MMEMory:STORe:TRACe1 "C:\My Documents\Trace1.trc"
stores Trace 1 data in the file Trace1.trc in the My Documents folder.

Related Commands :MMEMory:LOAD:TRACe<x>

:PROGrama Commands

The :PROGrama commands control running a macro program.

The macro program to be run must be stored under this directory in the analyzer:

C:\Program Files\Tektronix\wca200a\Python\wca200a\measmacro

For incorporating macro programs into the analyzer, contact your local Tektronix distributor or sales office. For an example of running a macro program, refer to page 4–14.

Command Tree

Header	Parameter
:PROGrama	
:CATalog?	
[:SElected]	
:DElete	
[:SElected]	
:EXECute	<command_name>
:NAME	<macro_name>
:NUMBer	<varname>, <nvalue>
:STRing	<varname>, <nvalue>

:PROGrama:CATalog? (Query Only)

Queries the list of the defined macro programs.

Syntax :PROGrama:CATalog?

Arguments None

Returns Comma-separated character strings as follows:

"macro_name{,macro_name}"{"macro_name{,macro_name}"}

macro_name represents a macro name.

If no program has been defined, a null character ("") is returned.

Measurement Modes All

Examples :PROGrama:CATalog?
might return "NONREGISTERED.MACROTEST1", "NONREGISTERED.MACROTEST2"
indicating that MacroTest1 and MacroTest2 are located under the directory *C:\Program Files\Tektronix\wca200a\Python\wca200a\measmacro\nonregistered*.

:PROGrama[:SElected]:DElete[:SElected] (No Query Form)

Deletes a macro program specified with the :PROGrama[:SElected]:NAME command, from the memory.

Syntax :PROGrama[:SElected]:DElete[:SElected]

Arguments None

Measurement Modes All

Examples :PROGrama:SElected:DElete:SElected
deletes the specified macro program.

Related Commands :PROGrama[:SElected]:NAME

:PROGrama[:SElected]:EXECute (No Query Form)

Runs a command included in the macro program folder specified with the :PROGrama[:SElected]:NAME command.

Syntax :PROGrama[:SElected]:EXECute <command_name>

Arguments <command_name>::=<string> specifies the command.

Returns If the specified command is not found, the following error message is returned:
"Program Syntax error" (-285)

Measurement Modes All

Examples :PROGrama:SElected:EXECute "TEST1"
runs the TEST1 command.

:PROGrama[:SElected]:NAME (?)

Specifies or queries the macro program folder.

Syntax :PROGrama[:SElected]:NAME <macro_name>
:PROGrama[:SElected]:NAME?

Arguments <macro_name>::=<string> specifies the macro program folder.

Returns If the specified macro is not found, the following error message is returned:
"Program Syntax error" (-285)

Measurement Modes All

Examples :PROGrama:SElected:NAME "NONREGISTERED.MACROTEST1"
specifies the macro program folder *MacroTest1* located under the directory *C:\Program Files\Tektronix\wca200a\Python\wca200a\measmacro\nonregistered*.

Related Commands :PROGrama[:SElected]:EXECute

:PROGrama:NUMBER (?)

Sets a numeric variable used in the macro program.

The query version of this command returns the numeric variable or the measurement result.

Syntax :PROGrama:NUMBER <varname>,<nvalues>
 :PROGrama:NUMBER? <varname>

Arguments <varname>::=<string> specifies the variable.
 <nvalues>::=<NRf> is the numeric value for the variable.

Returns <NRf> is the numeric value of the specified variable.

If the specified variable is not found, the following error message is returned:

 "Illegal variable name" (-283)

Measurement Modes All

Examples :PROGrama:NUMBER "LOW_LIMIT",1.5
 sets the variable LOW_LIMIT to 1.5.

 :PROGrama:NUMBER? "RESULT"
 might return 1.2345 of the measured value stored in the variable RESULT.

:PROGrama:STRing (?)

Sets a character variable used in the macro program.

The query form of this command returns the character variable or the measurement result (string).

Syntax :PROGrama:STRing <varname>,<svalues>
:PROGrama:STRing? <varname>

Arguments <varname>::=<string> specifies the variable.
<svalues>::=<string> is the string for the variable.

Returns <string> of the specified variable.

If the specified variable is not found, the following error message is returned:

"Illegal variable name" (-283)

Measurement Modes All

Examples :PROGrama:STRing "ERROR_MESSAGE","Measurement Unsuccessful"
sets the character string "Measurement Unsuccessful" in the variable
ERROR_MESSAGE.

:READ Commands

The :READ commands acquire an input signal once in the single mode and obtain the measurement results from that data.

If you want to fetch the measurement results from the data currently residing in the memory without acquiring the input signal, use the :FETCh commands.

Prerequisites for Use

To use a command of this group, you must have run at least the following two commands:

1. Select a measurement mode with the following command:

```
:INSTrument[:SElect] { SANORMAL | SASGRAM | SARTIME  
| DEMADEM | DEMDDEM | TIMCCDF | TIMTRAN | TIMPULSE }
```

2. Set the acquisition mode to single with the following command:

```
:INITiate:CONTinuous OFF
```

NOTE. If a :READ command is run in the continuous mode, the acquisition mode is changed to single.

Command Tree

Header	Parameter
:READ	
:ADEMod	
:AM?	
:RESult?	
:FM?	
:RESult?	
:PM?	
:CCDF?	
:DDEMod?	IQVTime FVTime CONSte EVM AEVM
(Option 21 only)	MERRor AMERRor PMERRor PERRor
	APERRor PPERror RHO SLEngth FERRor
	OOFFset STABle PVTTime AMAM AMPM
	CCDF PDF
:DISTRibution:CCDF?	
:OVIew?	
:PULSe?	ALL WIDTH PPOWer OORatio RIPPlE
	PERiod DCYClE PHASe CHPower
	OBWidth EBWidth FREQuency
:SPECTrum?	
:TAMPlitude?	
:TFRequency	
:SPECTrum?	
:ACPower?	
:CFRequency?	
:CHPower?	
:CNRatio?	
:EBWidth?	
:OBWidth?	
:SPURious?	
:TRANsient	
:FVTime?	
:IQVTime?	
:PVTTime?	

:READ:ADEMod:AM? (Query Only)

Obtains the results of the AM signal analysis in time series.

Syntax :READ:ADEMod:AM?

Arguments None

Returns #<Num_digit><Num_byte><Data(1)><Data(2)>...<Data(n)>

Where

<Num_digit> is the number of digits in <Num_byte>.

<Num_byte> is the number of bytes of the data that follow.

<Data(n)> is the chronological modulation factor data in percent (%).

4-byte little endian floating-point format specified in IEEE 488.2

n: Max 512000 (= 1024 points × 500 frames)

Measurement Modes DEMADEM

Examples :READ:ADEMod:AM?
might return #41024xxxx... (1024-byte data) for the results of the AM signal analysis.

Related Commands :INSTrument[:SElect]

:READ:ADEMod:AM:RESult? (Query Only)

Obtains the measurement results of the AM signal analysis.

Syntax :READ:ADEMod:AM:RESult?

Arguments None

Returns <+AM>,<-AM>,<Total_AM>

Where

<+AM>::=<NRf> is the positive peak AM value in percent (%).

<-AM>::=<NRf> is the negative peak AM value in percent (%).

<Total_AM>::=<NRf> is the total AM value: (peak-peak AM value) / 2
in percent (%).

Measurement Modes DEMADEM

Examples :READ:ADEMod:AM:RESult?
might return 37.34,-48.75,43.04.

Related Commands :INSTRument[:SElect]

:READ:ADEMod:FM? (Query Only)

Obtains the results of the FM signal analysis in time series.

Syntax :READ:ADEMod:FM?

Arguments None

Returns #<Num_digit><Num_byte><Data(1)><Data(2)>...<Data(n)>

Where

<Num_digit> is the number of digits in <Num_byte>.

<Num_byte> is the number of bytes of the data that follow.

<Data(n)> is the chronological frequency shift data in Hz.

4-byte little endian floating-point format specified in IEEE 488.2

n: Max 512000 (= 1024 points × 500 frames)

Measurement Modes DEMADEM

Examples :READ:ADEMod:FM?
might return #41024xxxx... (1024-byte data) for the results of the FM signal analysis.

Related Commands :INSTrument[:SElect]

:READ:ADEMod:FM:RESult? (Query Only)

Obtains the measurement results of the FM signal analysis.

Syntax :READ:ADEMod:FM:RESult?

Arguments None

Returns <+Pk_Freq_Dev>,<-Pk_Freq_Dev>,<P2P_Freq_Dev>,<P2P_Freq_Dev/2>,
 <RMS_Freq_Dev>

Where

<+Pk_Freq_Dev>::=<NRf> is the positive peak frequency deviation in Hz.

<-Pk_Freq_Dev>::=<NRf> is the negative peak frequency deviation in Hz.

<P2P_Freq_Dev>::=<NRf> is the peak-to-peak frequency deviation in Hz.

<P2P_Freq_Dev/2>::=<NRf> is (peak-to-peak frequency deviation) / 2 in Hz.

<RMS_Freq_Dev>::=<NRf> is the RMS frequency deviation in Hz.

Examples :READ:ADEMod:FM:RESult?
 might return 1.13e+4,-1.55e+4,2.48e+4,1.24e+4,1.03e+4.

Related Commands :INSTRument[:SElect]

:READ:ADEMod:PM? (Query Only)

Obtains the results of the PM signal analysis in time series.

Syntax :READ:ADEMod:PM?

Arguments None

Returns #<Num_digit><Num_byte><Data(1)><Data(2)>...<Data(n)>

Where

<Num_digit> is the number of digits in <Num_byte>.

<Num_byte> is the number of bytes of the data that follow.

<Data(n)> is the chronological phase shift data in degrees.

4-byte little endian floating-point format specified in IEEE 488.2

n: Max 512000 (= 1024 points × 500 frames)

Measurement Modes DEMADEM

Examples :READ:ADEMod:PM?
might return #41024xxxx... (1024-byte data) for the results of the PM signal analysis.

Related Commands :INSTrument[:SElect]

:READ:CCDF? (Query Only)

Obtains the CCDF measurement results.

Syntax :READ:CCDF?

Arguments None

Returns <meanpower>,<peakpower>,<cfactor>

Where

<meanpower>::=<NRf> is the average power measured value in dBm.

<peakpower>::=<NRf> is the peak power measured value in dBm.

<cfactor>::=<NRf> is the crest factor in dB.

Measurement Modes TIMCCDF

Examples :READ:CCDF?
might return -11.16,-8.18,2.96 for the CCDF measurement results.

Related Commands :INSTRument[:SElect]

:READ:DDEMod? (Query Only)**Option 21 Only**

Obtains the results of the digital modulation analysis.

Syntax :READ:DDEMod? { IQVTime | FVTime | CONStE | EVM | AEVM | PEVM
| MERRor | AMERror | PMERror | PERRor | APERror | PPERror | RHO
| SLENgth | FERRor | OOFFset | STABle | PVTTime | AMAM | AMPM
| CCDF | PDF }

Arguments Information queried is listed below for each of the arguments:

Table 2-40: Queried information on the digital modulation analysis results

Argument	Information queried
IQVTime	IQ level versus Time measured value
FVTime	Frequency versus Time measured value (for FSK demodulation only)
CONStE	Constellation measurement results (coordinates data array of symbols)
EVM	Error Vector Magnitude (EVM) measurement results
AEVM	EVM RMS value
PEVM	EVM peak value and its symbol number
MERRor	Amplitude error
AMERror	Amplitude error RMS value
PMERror	Amplitude error peak value and its symbol number
PERRor	Phase error
APERror	Phase error RMS value
PPERror	Phase error peak value and its symbol number
RHO	Value of waveform quality (ρ)
SLENgth	Number of analyzed symbols
FERRor	Frequency error
OOFFset	Origin offset value (Not available when [:SENSe]:DDEMod:FORMat is set to ASK, FSK or GFSK)
STABle	Data from symbol table
PVTTime	Power versus Time (Valid when [:SENSe]:DDEMod:FORMat is set to ASK)
AMAM	AM/AM measurement results
AMPM	AM/PM measurement results

Table 2–40: Queried information on the digital modulation analysis results (Cont.)

Argument	Information queried
CCDF	CCDF measurement results
PDF	PDF measurement results

Returns Returns are listed below for each of the arguments. You can select degrees or radians for the angular unit using the :UNIT:ANGLE command.

IQVTime. #<Num_digit><Num_byte><Idata(1)><Qdata(1)>
<Idata(2)><Qdata2>...<Idata(n)><Qdata(n)>

Where

<Num_digit> is the number of digits in <Num_byte>.

<Num_byte> is the number of bytes of data that follow.

<Idata(n)><Qdata(n)> is the I and Q signal level data in volts.

4-byte little endian floating-point format specified in IEEE 488.2

n: Max 512000 (= 1024 points × 500 frames)

FVTime. #<Num_digit><Num_byte><Data(1)><Data(2)>...<Data(n)>

Where

<Num_digit> is the number of digits in <Num_byte>.

<Num_byte> is the number of bytes of data that follow.

<Data(n)> is the frequency shift data in Hz for the point n.

4-byte little endian floating-point format specified in IEEE 488.2

n: Max 512000 (= 1024 points × 500 frames)

CONSt. #<Num_digit><Num_byte><Ip(1)><Qp(1)>...<Ip(n)><Qp(n)>

Where

<Num_digit> is the number of digits in <Num_byte>.

<Num_byte> is the number of bytes of data that follow.

<Ip(n)> is the sample position on the I axis in a normalized value.

<Qp(n)> is the sample position on the Q axis in a normalized value.

Both <Ip(n)> and <Qp(n)> are in the 4-byte little endian floating-point format specified in IEEE 488.2. n: Max 512000 (= 1024 points × 500 frames)

EVM. #<Num_digit><Num_byte><Evm(1)><Evm(2)>...<Evm(n)>

Where

<Num_digit> is the number of digits in <Num_byte>.

<Num_byte> is the number of bytes of data that follow.

<Evm(n)> is the value of symbol EVM in percent (%).

4-byte little endian floating-point format specified in IEEE 488.2

n: Max 512000 (= 1024 points × 500 frames)

AEVM. <aevm>::=<NRf> is the EVM RMS value in percent (%).

PEVM. <pevm>,<symb>

Where

<pevm>::=<NRf> is the EVM peak value in percent (%).

<symb>::=<NR1> is the symbol number for the EVM peak value.

MERRor. #<Num_digit><Num_byte><Merr(1)><Merr(2)>...<Merr(n)>

Where

<Num_digit> is the number of digits in <Num_byte>.

<Num_byte> is the number of bytes of data that follow.

<Merr(n)> is the value of amplitude error of symbol in percent (%).

4-byte little endian floating-point format specified in IEEE 488.2

n: Max 512000 (= 1024 points × 500 frames)

AMERror. <amer>::=<NRf> is the amplitude error RMS value in percent (%).

PMERror. <pmer>,<symb>

Where

<pmer>::=<NRf> is the amplitude error peak value in percent (%).

<symb>::=<NR1> is the symbol number for the amplitude error peak value.

PERRor. #<Num_digit><Num_byte><Perr(1)><Perr(2)>...<Perr(n)>

Where

<Num_digit> is the number of digits in <Num_byte>.

<Num_byte> is the number of bytes of data that follow.

<Perr(n)> is the value of phase error of symbol in degrees or radians.

4-byte little endian floating-point format specified in IEEE 488.2

n: Max 512000 (= 1024 points × 500 frames)

APERror. <aper>::=<NRf> is the phase error RMS in degrees or radians.

PPERror. <pper>, <symb>

Where

<pper>::=<NRf> is the phase error peak value in degrees or radians.

<symb>::=<NRf> is the symbol number for the phase error peak value.

RHO. <rho>::=<NRf> is the measured value of waveform quality (ρ).

SLENgth. <slen>::=<NR1> is the number of analyzed symbols.

FERRor. <ferr>::=<NRf> is the frequency error in Hz.

OOFFset. <ooff>::=<NRf> is the origin offset in dB.

STABle. #<Num_digit><Num_byte><Sym(1)><Sym(2)>...<Sym(n)>

Where

<Num_digit> is the number of digits in <Num_byte>.

<Num_byte> is the number of bytes of data that follow.

<Sym(n)>::=<NR1> is the symbol data.

n: Max 512000 (= 1024 points \times 500 frames)

PVTime. #<Num_digit><Num_byte><Data(1)><Data(2)>...<Data(n)>

Where

<Num_digit> is the number of digit in <Num_byte>.

<Num_byte> is the number of bytes of data that follow.

<Data(n)> is the time domain power data in dBm.

4-byte little endian floating-point format specified IEEE 488.2.

n: Max 512000 (= 1024 points \times 500 frames)

AMAM. <Comp>, <Coeff_num>{, <Coeff>}

Where

<Comp>::=<NRf> is the 1 dB compression point in dBm.

<Coeff_Num>::=<NR1> is the number of coefficients (1 to 16).

It is equal to the value set using the [:SENSe]:DDEMod:NLINearity:COEFFi-
cient command plus 1.

<Coeff>::=<NRf> is the coefficient value.

AMPM. <Coeff_num>{,<Coeff>}

Where

<Coeff_Num>::=<NR1> is the number of coefficients (1 to 16).

It is equal to the value set using the [:SENSe]:DDEMod:NLINearity:COEFFi-
cient command plus 1.

<Coeff>::=<NRf> is the coefficient value.

CCDF. <Mean_Power_D>,<Peak_Power_D>,<Crest_Factor_D>,
<Mean_Power_R>,<Peak_Power_R>,<Crest_Factor_R>

Where

<Mean_Power_D>::=<NRf> is the measured average power in dBm.

<Peak_Power_D>::=<NRf> is the measured peak power in dBm.

<Crest_Factor_D>::=<NRf> is the measured crest factor in dB.

<Mean_Power_R>::=<NRf> is the reference average power in dBm.

<Peak_Power_R>::=<NRf> is the reference peak power in dBm.

<Crest_Factor_R>::=<NRf> is the reference crest factor in dB.

PDF. <Mean_Power_D>,<Peak_Power_D>,<Mean_Power_R>,<Peak_Power_R>

Where

<Mean_Power_D>::=<NRf> is the measured average power in dBm.

<Peak_Power_D>::=<NRf> is the measured peak power in dBm.

<Mean_Power_R>::=<NRf> is the reference average power in dBm.

<Peak_Power_R>::=<NRf> is the reference peak power in dBm.

Measurement Modes

DEMDDEM

Examples

:READ:DDEMod? IQVTime

might return #41024xxxx... (1024-byte data) for the IQ level versus time
measurement results.

Related Commands

:INSTrument[:SElect], [:SENSe]:DDEMod:FORMat, :UNIT:ANGLE

:READ:DISTribution:CCDF? (Query Only)

Returns the CCDF trace data in the CCDF measurement.

Syntax :READ:DISTribution:CCDF?

Arguments None

Returns #<Num_digit><Num_byte><Data(1)><Data(2)>...<Data(n)>

Where

<Num_digit> is the number of digits in <Num_byte>.

<Num_byte> is the number of bytes of the data that follow.

<Data(n)> is the phase shift data in degrees for the point n.

4-byte little endian floating-point format specified in IEEE 488.2

n: Max 10001

Invalid data is returned as -1000.

Measurement Modes TIMCCDF

Examples :READ:DISTribution:CCDF?
might return #41024xxxx... (1024-byte data) for the CCDF trace data in the CCDF measurement.

Related Commands :READ:CCDF?, :INSTrument[:SElect]

:READ:OVlew? (Query Only)

Obtains the minimum and maximum values for each 1024-point segment of waveform data displayed on the overview in the Demod (modulation analysis) and the Time (time analysis) modes.

NOTE. The :CONFigure:OVlew command must be run to turn measurement off before the :READ:OVlew command is executed.

Syntax :READ:OVlew?

Returns #<Num_digit><Num_byte><MinData(1)><MaxData(1)>...
<MinData(n)><MaxData(n)>

Where

<Num_digit> is the number of digits in <Num_byte>.

<Num_byte> is the number of bytes of the data that follow.

<MinData(n)> is the minimum data in dBm for each 1024 data point segment.
4-byte little endian floating-point format specified in IEEE 488.2

<MaxData(n)> is the maximum data in dBm for each 1024 data point segment.
4-byte little endian floating-point format specified in IEEE 488.2

n: Max 16000 (standard) / 64000 (Option 02)

Measurement Modes DEMADEM, TIMCCDF, TIMTRAN, TIMPULSE

Examples :READ:OVlew?
might return #510240xxx... (10240-byte data) representing the minimum and the maximum values of waveform displayed on the overview.

Related Commands :CONFigure:OVlew, :INSTrument[:SElect]

:READ:PULSe? (Query Only)

Returns the result of the pulse characteristics analysis.

Syntax :READ:PULSe? { ALL | WIDTH | PPOWer | OORatio | RIPPlE | PERiod
| DCYClE | PHASe | CHPower | OBWidth | EBWidth | FREQuency }

Arguments Information queried is listed below for each of the arguments:

Argument	Information queried
ALL	All
WIDTH	Pulse width
PPOWer	Maximum (peak) power in the pulse-on time
OORatio	Difference between the pulse-on time power and off time power
RIPPlE	Difference between the maximum and the minimum power in the pulse-on
PERiod	Time between the pulse rising edge and the next rising edge
DCYClE	Ratio of the pulse width to the pulse repetition interval (PRI)
PHASe	Phase at a certain point of each pulse
CHPower	Channel power of the pulse-on time spectrum
OBWidth	OBW (Occupied Bandwidth) of the pulse-on time spectrum
EBWidth	EBW (Emission Bandwidth) of the pulse-on time spectrum
FREQuency	Carrier frequency in the pulse-on time

Returns Returns are listed below for each of the arguments.

ALL. <width>,<ppower>,<ooratio>,<ripple>,<period>,<dcycle>,<phase>,<chp>,<obw>,<ebw>,<freq>

Where

<width>::=<NRf> is the pulse width in s.

<ppower>::=<NRf> is the peak power in watts.

<ooratio>::=<NRf> is the on/off ratio in dB.

<ripple>::=<NRf> is the pulse ripple in watts.

<period>::=<NRf> is the pulse repetition interval in s.

<dcycle>::=<NRf> is the duty cycle in percent (%).

<phase>::=<NRf> is the pulse-pulse phase in degrees.

<chp>::=<NRf> is the channel power in watts.

<obw>::=<NRf> is the OBW in Hz.

<ebw>::=<NRf> is the EBW in Hz.

<freq>::=<NRf> is the frequency deviation in Hz.

WIDTH. #<Num_digit><Num_byte><Width(1)><Width(2)>...<Width(n)>

Where

<Num_digit> is the number of digits in <Num_byte>.

<Num_byte> is the number of bytes of the data that follow.

<Width(n)> is the pulse width value for each pulse number.

4-byte little endian floating-point format specified in IEEE 488.2

n: Max 1000

PPower. #<Num_digit><Num_byte><Ppower(1)><Ppower(2)>...<Ppower(n)>

Where

<Num_digit> is the number of digits in <Num_byte>.

<Num_byte> is the number of bytes of the data that follow.

<Power(n)> is the peak power value for each pulse number.

4-byte little endian floating-point format specified in IEEE 488.2

n: Max 1000

OORatio. #<Num_digit><Num_byte><Ooratio(1)><Ooratio(2)>...<Ooratio(n)>

Where

<Num_digit> is the number of digits in <Num_byte>.

<Num_byte> is the number of bytes of the data that follow.

<Ooratio(n)> is the on/off ratio value for each pulse number.

4-byte little endian floating-point format specified in IEEE 488.2

n: Max 1000

RIPPLE. #<Num_digit><Num_byte><Ripple(1)><Ripple(2)>...<Ripple(n)>

Where

<Num_digit> is the number of digits in <Num_byte>.

<Num_byte> is the number of bytes of the data that follow.

<Ripple(n)> is the ripple value for each pulse number.

4-byte little endian floating-point format specified in IEEE 488.2

n: Max 1000

PERiod. #<Num_digit><Num_byte><Period(1)><Period(2)>...<Period(n)>

Where

<Num_digit> is the number of digits in <Num_byte>.

<Num_byte> is the number of bytes of the data that follow.

<Period(n)> is the pulse repetition interval value for each pulse number.

4-byte little endian floating-point format specified in IEEE 488.2

n: Max 1000

DCYClE. #<Num_digit><Num_byte><Dcycle(1)><Dcycle(2)>...<Dcycle(n)>

Where

<Num_digit> is the number of digits in <Num_byte>.

<Num_byte> is the number of bytes of the data that follow.

<Dcycle(n)> is the duty value for each pulse number.

4-byte little endian floating-point format specified in IEEE 488.2

n: Max 1000

PHASe. #<Num_digit><Num_byte><Phase(1)><Phase(2)>...<Phase(n)>

Where

<Num_digit> is the number of digits in <Num_byte>.

<Num_byte> is the number of bytes of the data that follow.

<Phase(n)> is the pulse-pulse phase value for each pulse number.

4-byte little endian floating-point format specified in IEEE 488.2

n: Max 1000

CHPower. #<Num_digit><Num_byte><Chp(1)><Chp(2)>...<Chp(n)>

Where

<Num_digit> is the number of digits in <Num_byte>.

<Num_byte> is the number of bytes of the data that follow.

<Chp(n)> is the Channel Power value for each pulse number.

4-byte little endian floating-point format specified in IEEE 488.2

n: Max 1000

OBWidth. #<Num_digit><Num_byte><Obw(1)><Obw(2)>...<Obw(n)>

Where

<Num_digit> is the number of digits in <Num_byte>.

<Num_byte> is the number of bytes of the data that follow.

<Obw(n)> is the OBW value for each pulse number.

4-byte little endian floating-point format specified in IEEE 488.2

n: Max 1000

EBWidth. #<Num_digit><Num_byte><Ebw(1)><Ebw(2)>...<Ebw(n)>

Where

<Num_digit> is the number of digits in <Num_byte>.

<Num_byte> is the number of bytes of the data that follow.

<Ebw(n)> is the EBW value for each pulse number.

4-byte little endian floating-point format specified in IEEE 488.2

n: Max 1000

FREQUENCY. #<Num_digit><Num_byte><Freq(1)><Freq(2)>...<Freq(n)>

Where

<Num_digit> is the number of digits in <Num_byte>.

<Num_byte> is the number of bytes of the data that follow.

<Freq(n)> is the frequency deviation value for each pulse number.

4-byte little endian floating-point format specified in IEEE 488.2

n: Max 1000

Measurement Modes TIMPULSE

Examples :READ:PULSe? WIDTH
might return #3500xxxx... (500-byte data) for the pulse width measurement result.

Related Commands :INSTrument[:SElect]

:READ:PULSE:SPECTrum? (Query Only)

Returns the spectrum data of the frequency domain measurement in the pulse characteristics analysis.

This query command is valid when :DISPlay:PULSE:SView:FORMat is set to CHPowr, OBWidth, or EBWidth.

Syntax :READ:PULSE:SPECTrum?

Arguments None

Returns #<Num_digit><Num_byte><Data(1)><Data(2)>...<Data(n)>

Where

<Num_digit> is the number of digits in <Num_byte>.

<Num_byte> is the number of bytes of data that follow.

<Data(n)> is the spectrum in dBm.

4-byte little endian floating-point format specified IEEE 488.2.

n: Max 16384

Measurement Modes TIMPULSE

Examples :READ:PULSE:SPECTrum?
might return #43200xxxx... (3200-byte data) for the spectrum data.

Related Commands :DISPlay:PULSE:SView:FORMat, :INSTrument[:SElect]

:READ:PULSe:TAMPlitude? (Query Only)

Returns the time domain amplitude data of the time domain measurement in the pulse characteristics analysis.

This query command is valid when :DISPlay:PULSe:SVIew:FORMat is set to WIDTh, PPOWer, OORatio, RIPPlE, PERiod, DCYClE, or PHASe.

Syntax :READ:PULSe:TAMPlitude?

Arguments None

Returns #<Num_digit><Num_byte><Data(1)><Data(2)>...<Data(n)>

Where

<Num_digit> is the number of digits in <Num_byte>.

<Num_byte> is the number of bytes of data that follow.

<Data(n)> is the absolute power for each data in watts.

4-byte little endian floating-point format specified IEEE 488.2.

n: Max 262,144

Invalid data is returned as -1000.

Measurement Modes TIMPULSE

Examples :READ:PULSe:TAMPlitude?
might return #43200xxxx... (3200-byte data) for the time domain amplitude.

Related Commands :DISPlay:PULSe:SVIew:FORMat, :INSTrument[:SElect]

:READ:PULSe:TFrequency? (Query Only)

Returns the frequency deviation measurement results in the pulse characteristics analysis.

This query command is valid when :DISPlay:PULSe:SVIew:FORMat is set to FREQuency.

Syntax :READ:PULSe:TFrequency?

Arguments None

Returns #<Num_digit><Num_byte><Data(1)><Data(2)>...<Data(n)>

Where

<Num_digit> is the number of digits in <Num_byte>.

<Num_byte> is the number of bytes of data that follow.

<Data(n)> is the frequency deviation value in Hz on the time axis.

4-byte little endian floating-point format specified IEEE 488.2.

n: Max 262,144

Invalid data is returned as -1000.

Measurement Modes TIMPULSE

Examples :READ:PULSe:TFrequency?
might return #43200xxxx... (3200-byte data) for the time domain frequency.

Related Commands :DISPlay:PULSe:SVIew:FORMat, :INSTrument[:SElect]

:READ:SPECTrum? (Query Only)

Obtains spectrum waveform data in the S/A (spectrum analysis) mode.

Syntax :READ:SPECTrum?

Arguments None

Returns #<Num_digit><Num_byte><Data(1)><Data(2)>...<Data(n)>

Where

<Num_digit> is the number of digits in <Num_byte>.

<Num_byte> is the number of bytes of the data that follow.

<Data(n)> is the amplitude spectrum in dBm.

4-byte little endian floating-point format specified in IEEE 488.2

n: Max 240001

Measurement Modes SANORMAL, SASGRAM, SARTIME

Examples :READ:SPECTrum?
might return #43200xxxx... (3200-byte data) for the spectrum waveform data.

Related Commands :INSTrument[:SElect]

:READ:SPECTrum:ACPower? (Query Only)

Obtains the results of the adjacent channel leakage power ratio (ACPR) measurement in the S/A mode.

Syntax :READ:SPECTrum:ACPower?

Arguments None

Returns <chpower>,<acpm1>,<acpp1>,<acpm2>,<acpp2>,<acpm3>,<acpp3>

Where

<chpower>::=<NRf> is the channel power measured value in dBm.

<acpm1>::=<NRf> is the first lower adjacent channel ACPR in dB.

<acpp1>::=<NRf> is the first upper adjacent channel ACPR in dB.

<acpm2>::=<NRf> is the second lower adjacent channel ACPR in dB.

<acpp2>::=<NRf> is the second upper adjacent channel ACPR in dB.

<acpm3>::=<NRf> is the third lower adjacent channel ACPR in dB.

<acpp3>::=<NRf> is the third upper adjacent channel ACPR in dB.

NOTE. All the values may not be returned when the adjacent channel(s) goes out of the span due to the settings of the channel bandwidth and spacing (refer to the [:SENSe]:ACPower subgroup). For example, if the third adjacent channel goes out of the span, the response is <chpower>,<acpm1>,<acpp1>,<acpm2>,<acpp2>; <acpm3> and <acpp3> are not returned.

Measurement Modes SANORMAL, SASGRAM, SARTIME

Examples :READ:SPECTrum:ACPower?
might return -11.38,-59.41,-59.51,-59.18,-59.31,-59.17,-59.74 for the ACPR measurement results.

Related Commands :INSTrument[:SElect], [:SENSe]:ACPower subgroup

:READ:SPECTrum:CFRequency? (Query Only)

Obtains the results of the carrier frequency measurement in the S/A mode.

Syntax :READ:SPECTrum:CFRequency?

Arguments None

Returns <cfreq>::=<NRf> is the measured value of the carrier frequency in Hz.

Measurement Modes SANORMAL, SASGRAM, SARTIME

Examples :READ:SPECTrum:CFRequency?
might return 846187328.5 for the carrier frequency.

Related Commands :INSTrument[:SElect]

:READ:SPECTrum:CHPower? (Query Only)

Obtains the results of the channel power measurement in the S/A mode.

Syntax :READ:SPECTrum:CHPower?

Arguments None

Returns <chpower>::=<NRf> is the channel power measured value in dBm.

Measurement Modes SANORMAL, SASGRAM, SARTIME

Examples :READ:SPECTrum:CHPower?
might return -1.081 for the measurement results of the channel power.

Related Commands :INSTrument[:SElect]

:READ:SPECTrum:CNRatio? (Query Only)

Obtains the results of the carrier-to-noise ratio (C/N) measurement in the S/A (spectrum analysis) mode.

Syntax :READ:SPECTrum:CNRatio?

Arguments None

Returns <ctn>,<ctno>

Where

<ctn>::=<NRf> is the measured value of C/N in dB.

<ctno>::=<NRf> is the measured value of C/No in dB/Hz.

Measurement Modes SANORMAL, SASGRAM, SARTIME

Examples :READ:SPECTrum:CNRatio?
might return 75.594,125.594 for the C/N measurement results.

Related Commands :INSTrument[:SElect]

:READ:SPECTrum:EBWidth? (Query Only)

Obtains the results of the emission bandwidth (EBW) measurement in the S/A (spectrum analysis) mode.

Syntax :READ:SPECTrum:EBWidth?

Arguments None

Returns <ebw>::=<NRf> is the measured value of EBW in Hz.

Measurement Modes SANORMAL, SASGRAM, SARTIME

Examples :READ:SPECTrum:EBWidth?
might return 30956.26 for the EBW measurement results.

Related Commands :INSTrument[:SElect]

:READ:SPECTrum:OBWidth? (Query Only)

Obtains the results of the occupied bandwidth (OBW) measurement in the S/A (spectrum analysis) mode.

Syntax :READ:SPECTrum:OBWidth?

Arguments None

Returns <obw>::=<NRf> is the measured value of OBW in Hz.

Measurement Modes SANORMAL, SASGRAM, SARTIME

Examples :READ:SPECTrum:OBWidth?
might return 26510.163 for the OBW measurement results.

Related Commands :INSTrument[:SElect]

:READ:SPECTrum:SPURious? (Query Only)

Obtains the results of the spurious signal measurement in the S/A (spectrum analysis) mode.

Syntax :READ:SPECTrum:SPURious?

Arguments None

Returns <snum>{,<dfreq>,<rdb>}

Where

<snum>::=<NR1> is the number of detected spurious emissions, max. 20

<dfreq>::=<NRf> is the detuned frequency of spurious relative to carrier in Hz.

<rdb>::=<NRf> is the relative level of spurious signal to carrier in dB.

Measurement Modes SANORMAL, SASGRAM, SARTIME

Examples :READ:SPECTrum:SPURious?
might return 3,1.2E6,-79,2.4E6,-79.59,1E6,-80.38 for the spurious signal measurement.

Related Commands :INSTRument[:SElect]

:READ:TRANSient:FVTime? (Query Only)

Obtains the results of the frequency vs. time measurement in the Time (time analysis) mode.

Syntax :READ:TRANSient:FVTime?

Arguments None

Returns #<Num_digit><Num_byte><Data(1)><Data(2)>...<Data(n)>

Where

<Num_digit> is the number of digits in <Num_byte>.

<Num_byte> is the number of bytes of the data that follow.

<Data(n)> is the chronological frequency data in Hz.

4-byte little endian floating-point format specified in IEEE 488.2

n: Max 512000 (= 1024 points × 500 frames)

Measurement Modes TIMTRAN

Examples :READ:TRANSient:FVTime?
might return #41024xxxx... (1024-byte data) for the results of the frequency vs. time measurement.

Related Commands :INSTrument[:SElect]

:READ:TRANSient:IQVTime? (Query Only)

Obtains the results of the IQ level vs. time measurement in the Time (time analysis) mode.

Syntax :READ:TRANSient:IQVTime?

Arguments None

Returns #<Num_digit><Num_byte><Idata(1)><Qdata(1)>
<Idata(2)><Qdata2>...<Idata(n)><Qdata(n)>

Where

<Num_digit> is the number of digits in <Num_byte>.

<Num_byte> is the number of bytes of the data that follow.

<Idata(n)><Qdata(n)> is the I and Q signal level data in volts.

4-byte little endian floating-point format specified in IEEE 488.2

n: Max 512000 (= 1024 points × 500 frames)

Measurement Modes TIMTRAN

Examples :READ:TRANSient:IQVTime?
might return #41024xxxx... (1024-byte data) for the results of the
IQ level vs. time measurement.

Related Commands :INSTrument[:SElect]

:READ:TRANSient:PVTime? (Query Only)

Obtains the results of the power measurement vs. time in the Time (time analysis) mode.

Syntax :READ:TRANSient:PVTime?

Arguments None

Returns #<Num_digit><Num_byte><Data(1)><Data(2)>...<Data(n)>

Where

<Num_digit> is the number of digits in <Num_byte>.

<Num_byte> is the number of bytes of the data that follow.

<Data(n)> is the chronological power data in dBm.

4-byte little endian floating-point format specified in IEEE 488.2

n: Max 512000 (= 1024 points × 500 frames)

Measurement Modes TIMTRAN

Examples :READ:TRANSient:PVTime?
might return #41024xxxx... (1024-byte data) for the results of the power vs. time measurement.

Related Commands :INSTrument[:SElect]

:SENSe Commands

The :SENSe commands set the details for each of the measurement sessions. They are divided into the following subgroups:

Table 2-41: :SENSe command subgroups

Command header	Function	Refer to:
[:SENSE]:ACPower	Set up ACPR measurement	p. 2-274
[:SENSE]:ADEMod	Set up analog modulation analysis	p. 2-278
[:SENSE]:AVERage	Set up average	p. 2-284
[:SENSE]:BSIZe	Set the block size	p. 2-287
[:SENSE]:CCDF	Set up CCDF measurement	p. 2-288
[:SENSE]:CFRequency	Set up carrier frequency measurement	p. 2-291
[:SENSE]:CHPower	Set up channel power measurement	p. 2-292
[:SENSE]:CNRatio	Set up C/N measurement	p. 2-295
[:SENSE]:CORRection	Set up amplitude correction	p. 2-300
[:SENSE]:DDEMod (Option 21 only)	Set up digital modulation analysis	p. 2-305
[:SENSE]:EBWidth	Set up EBW measurement	p. 2-324
[:SENSE]:FEED	Set up signal path	p. 2-326
[:SENSE]:FREQuency	Set up frequency-related conditions	p. 2-327
[:SENSE]:OBWidth	Set up OBW measurement	p. 2-336
[:SENSE]:PULSe	Set up pulse characteristics measurement.	p. 2-338
[:SENSE]:ROSCillator	Set up reference oscillator	p. 2-347
[:SENSE]:SPECTrum	Set up spectrum measurement	p. 2-348
[:SENSE]:SPURious	Set up spurious signal measurement	p. 2-360
[:SENSE]:TRANsient	Set up time domain measurement	p. 2-364

[[:SENSe]:ACPower Subgroup

The [[:SENSe]:ACPower commands set up the conditions related to the adjacent channel leakage power ratio (ACPR) measurement in the S/A (spectrum analysis) mode.

Command Tree	Header	Parameter
	[SENSe]	
	:ACPower	
	:BANDwidth :BWIDth	
	:ACHannel	<frequency>
	:INTEgration	<frequency>
	:CSPacing	<frequency>
	:FILTer	
	:COEFFicient	<numeric_value>
	:TYPE	RECTangle GAUSSian NYQuist RNYQuist

Prerequisites for Use

To use a command of this group, you must have run at least the following two commands:

1. Run the following command to set the measurement mode to S/A:

```
:INSTRument[:SElect] { SANORMAL | SASGRAM | SARTIME }
```

2. Run one of the following commands to start the ACPR measurement:

- To start the measurement with the default settings:
:CONFIgure:SPECTrum:ACPower
- To start the measurement without modifying the current settings:
[:SENSe]:SPECTrum:MEASurement ACPower

[:SENSe]:ACPower:BANDwidth|:BWIDth:ACHannel(?)

Sets or queries the bandwidth of the adjacent channels for the ACPR measurement (see Figure 2–16).

Syntax [:SENSe]:ACPower:BANDwidth|:BWIDth:ACHannel <value>
 [:SENSe]:ACPower:BANDwidth|:BWIDth:ACHannel?

Arguments <value>::=<Nrf> specifies the bandwidth of the adjacent channels for the ACPR measurement. Range: (Bin bandwidth) × 8 to full span [Hz]. Refer to the *RSA3303A and RSA3308A User Manual* for the bin bandwidth.

Measurement Modes SANORMAL, SASGRAM, SARTIME

Examples :SENSe:ACPower:BANDwidth:ACHannel 3.5MHz
 sets the bandwidth of the adjacent channels to 3.5 MHz.

[:SENSe]:ACPower:BANDwidth|:BWIDth:INTEgration(?)

Sets or queries the bandwidth of the main channel for the ACPR measurement (see Figure 2–16).

Syntax [:SENSe]:ACPower:BANDwidth|:BWIDth:INTEgration <value>
 [:SENSe]:ACPower:BANDwidth|:BWIDth:INTEgration?

Arguments <value>::=<Nrf> specifies the bandwidth of the main channel for the ACPR measurement. Range: (Bin bandwidth) × 8 to full span [Hz]. Refer to the *RSA3303A and RSA3308A User Manual* for the bin bandwidth.

Measurement Modes SANORMAL, SASGRAM, SARTIME

Examples :SENSe:ACPower:BANDwidth:INTEgration 3.5MHz
 sets the bandwidth of the main channel to 3.5 MHz.

[:SENSe]:ACPower:CS pacing(?)

Sets or queries the channel-to-channel spacing for the ACPR measurement (see Figure 2–16).

Syntax [:SENSe]:ACPower:CS pacing <value>

[:SENSe]:ACPower:CS pacing?

Arguments <value>::=<NRF> specifies the channel-to-channel spacing for the ACPR measurement. Range: (Bin bandwidth) × 8 to full span [Hz]. Refer to the *RSA3303A and RSA3308A User Manual* for the bin bandwidth.

Measurement Modes SANORMAL, SASGRAM, SARTIME

Examples :SENSe:ACPower:CS pacing 5MHz
sets the channel-to-channel spacing to 5 MHz.

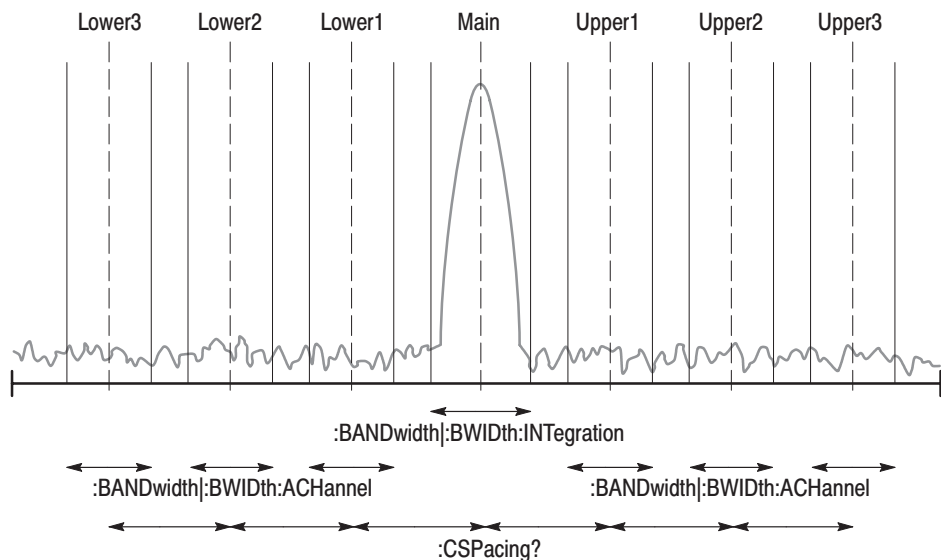

NOTE: The command header [:SENSe]:ACPower is omitted here.

Figure 2–16: Setting up the ACPR measurement

[:SENSe]:ACPower:FILTer:COEFFicient(?)

Sets or queries the filter roll-off rate for the ACPR measurement when you have selected either NYQuist (Nyquist filter) or RNYQuist (Root Nyquist filter) using the [:SENSe]:ACPower:FILTer:TYPE command.

Syntax [:SENSe]:ACPower:FILTer:COEFFicient <ratio>
[:SENSe]:ACPower:FILTer:COEFFicient?

Arguments <ratio>::=<NRf> specifies the roll-off rate. Range: 0 to 1.

Measurement Modes SANORMAL, SASGRAM, SARTIME

Examples :SENSe:ACPower:FILTer:COEFFicient 0.5
sets the filter roll-off rate to 0.5.

Related Commands [:SENSe]:ACPower:FILTer:TYPE

[:SENSe]:ACPower:FILTer:TYPE(?)

Selects or queries the filter for the ACPR measurement.

Syntax [:SENSe]:ACPower:FILTer:TYPE { RECTangle | GAUSSian | NYQuist
| RNYQuist }
[:SENSe]:ACPower:FILTer:TYPE?

Arguments RECTangle selects the rectangular filter.
GAUSSian selects the Gaussian filter.
NYQuist selects the Nyquist filter (default).
RNYQuist selects the Root Nyquist filter.

Measurement Modes SANORMAL, SASGRAM, SARTIME

Examples :SENSe:ACPower:FILTer:TYPE NYQuist
selects the Nyquist filter for the ACPR measurement.

[:SENSe]:ADEMod Subgroup

Sets up the analog modulation analysis.

NOTE. To use a command of this group, you must have selected *DEMADEM* (analog modulation analysis) in the *:INSTrument[:SElect]* command.

Command Tree	Header	Parameter
	[[:SENSe]	
	:ADEMod	
	:BLOCk	<numeric_value>
	:CARRier	
	:OFFSet	<numeric_value>
	:SEARCh	<boolean>
	:FM	
	:THReshold	<numeric_value>
	[[:IMMediate]	
	:LENGth	<numeric_value>
	:MODulation	AM FM PM IQVT OFF
	:OFFSet	<numeric_value>
	:PM	
	:THReshold	<numeric_value>

For the commands defining the analysis range, see the figure below. The analysis range is shown by a green line in the overview.

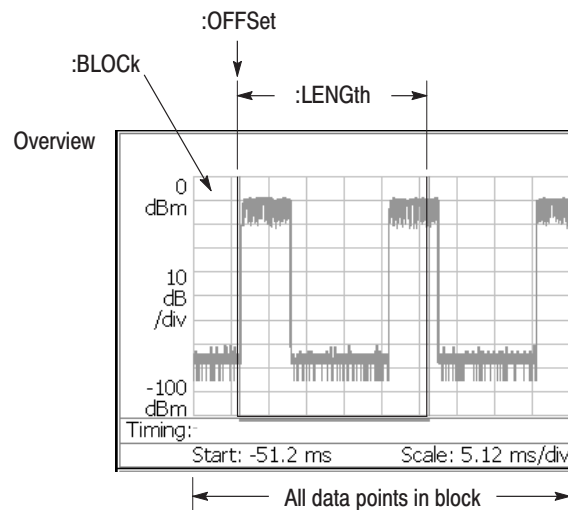

NOTE: Command header [:SENSe]:ADEMod is omitted here.

Figure 2-17: Defining the analysis range

[:SENSe] :ADEMod :BLOCk (?)

Sets or queries the number of the block to measure in the analog modulation analysis (see Figure 2–17).

Syntax [:SENSe] :ADEMod :BLOCk <number>
[:SENSe] :ADEMod :BLOCk ?

Arguments <number> : := <NR1> specifies the block number. Zero represents the latest block. Range: –M to 0 (M: Number of acquired blocks)

Measurement Modes DEMADEM

Examples :SENSe :ADEMod :BLOCk –5
sets the block number to –5.

[:SENSe] :ADEMod :CARRier :OFFSet (?)

Sets or queries the carrier frequency offset in the FM signal analysis.

Syntax [:SENSe] :ADEMod :CARRier :OFFSet <freq>
[:SENSe] :ADEMod :CARRier :OFFSet ?

Arguments <freq> : := <NR1> is the carrier frequency offset. Range: –30 to +30 MHz

Measurement Modes DEMADEM

Examples :SENSe :ADEMod :CARRier :OFFSet 10MHz
sets the carrier frequency offset to 10 MHz.

Related Commands [:SENSe] :ADEMod :CARRier :SEARCh

[[:SENSe]:ADEMod:CARRier:SEARch(?)

Determines whether to detect the carrier automatically in the FM signal analysis.

Syntax [:SENSe]:ADEMod:CARRier:SEARch { 0 | 1 | OFF | ON }
[:SENSe]:ADEMod:CARRier:SEARch?

Arguments OFF or 0 specifies that the carrier is not detected automatically.
To set it, use the [:SENSe]:ADEMod:CARRier:OFFSet command.
ON or 1 specifies that the carrier is detected automatically.

Measurement Modes DEMADEM

Examples :SENSe:ADEMod:CARRier:SEARch ON
specifies that the carrier is detected automatically.

Related Commands [:SENSe]:ADEMod:CARRier:OFFSet

[[:SENSe]:ADEMod:FM:THReshold(?)

Sets or queries the threshold level above which the input signal is determined to be a burst in the FM signal analysis. The burst detected first is used for the measurement.

Syntax [:SENSe]:ADEMod:FM:THReshold <value>
[:SENSe]:ADEMod:FM:THReshold?

Arguments <value>::=<NRf> specifies the threshold level. Range: -100.0 to 0.0 dB.

Measurement Modes DEMADEM

Examples :SENSe:ADEMod:FM:THReshold -10
sets the threshold level to -10 dB.

[[:SENSe]:ADEMod[:IMMediate] (No Query Form)

Runs the analog demodulation calculation for the acquired data. To select the analog demodulation method, use the [:SENSe]:ADEMod:MODulation command. To acquire data, use the :INITiate command.

Syntax [:SENSe]:ADEMod[:IMMediate]

Arguments None

Measurement Modes DEMADEM

Examples :SENSe:ADEMod:IMMediate
runs the analog demodulation calculation.

Related Commands :INITiate, [:SENSe]:ADEMod:MODulation

[[:SENSe]:ADEMod:LENGth(?)

Sets or queries the range for the analog modulation analysis (see Figure 2–17).

Syntax [:SENSe]:ADEMod:LENGth <value>

[:SENSe]:ADEMod:LENGth?

Arguments <value>::=<NR1> specifies the analysis range by the number of data points. Range: 1 to $1024 \times \text{Block size}$ (Block size ≤ 500).

To set the block size, use the [:SENSe]:BSIZE command.

Measurement Modes DEMADEM

Examples :SENSe:ADEMod:LENGth 1000
sets the analysis range to 1000 points.

Related Commands [:SENSe]:BSIZE

[:SENSe]:ADEMod:MODulation(?)

Selects or queries the measurement item of the analog modulation analysis.

Syntax [:SENSe]:ADEMod:MODulation { AM | FM | PM | IQVT | OFF }
[:SENSe]:ADEMod:MODulation?

Arguments The arguments and measurement items are listed below:

Table 2–42: Measurement item selections

Argument	Measurement item
AM	AM signal analysis
FM	FM signal analysis
PM	PM signal analysis
IQVT	IQ level vs. time measurement
OFF	Turns off the measurement.

Measurement Modes DEMADEM

Examples :SENSe:ADEMod:MODulation PM
selects the PM signal analysis.

[:SENSe]:ADEMod:OFFSet(?)

Sets or queries the measurement start position for the analog modulation analysis (see Figure 2–17).

Syntax [:SENSe]:ADEMod:OFFSet <value>
 [:SENSe]:ADEMod:OFFSet?

Arguments <value>::=<NR1> specifies the measurement start position by the number of points. Range: 0 to $1024 \times (\text{Block size}) - 1$. To set the block size, use the [:SENSe]:BSIZE command.

Measurement Modes DEMADEM

Examples :SENSe:ADEMod:OFFSet 500
 sets the measurement start position to point 500.

Related Commands [:SENSe]:BSIZE

[:SENSe]:ADEMod:PM:THReshold(?)

Sets or queries the threshold level above which the input signal is determined to be a burst in the PM signal analysis. The burst detected first is used for the measurement.

Syntax [:SENSe]:ADEMod:PM:THReshold <value>
 [:SENSe]:ADEMod:PM:THReshold?

Arguments <value>::=<NRf> specifies the threshold level. Range: –100.0 to 0.0 dB.

Measurement Modes DEMADEM

Examples :SENSe:ADEMod:PM:THReshold –10
 sets the threshold level to –10 dB.

[[:SENSe]:AVERage Subgroup

The [[:SENSe]:AVERage commands control average process for measured values in the modulation analysis (Demod mode) and the time analysis (Time mode).

NOTE. *Data is always acquired without averaging in the Demod and the Time modes.*

Command Tree	Header	Parameter
	[[:SENSe]	
	:AVERage	
	:CLEar	
	:COUnT	<numeric_value>
	[:STATE]	<boolean>
	:TCONtrol	EXPonential REPeat

[:SENSe]:AVERAge:CLEAr (No Query Form)

Clears average data and counter, and restarts the average process.

Syntax [:SENSe]:AVERAge:CLEAr

Arguments None

Measurement Modes DEMADEM, TIMCCDF, TIMTRAN, TIMPULSE

Examples :SENSe:AVERAge:CLEAr
clears average data and counter, and restarts the average process.

[:SENSe]:AVERAge:COUNT(?)

Sets or queries the number of traces to combine using the RMS average. After :COUNT traces have been averaged, the average process is controlled by the :TCONtrol setting (refer to page 2–286).

Syntax [:SENSe]:AVERAge:COUNT <value>
[:SENSe]:AVERAge:COUNT?

Arguments <value>::=<NR1> is the number of traces to combine for averaging.
Range: 1 to 100000 (default: 20)

Measurement Modes DEMADEM, TIMTRAN, TIMPULSE

Examples :SENSe:AVERAge:COUNT 64
sets the average count to 64.

Related Commands [:SENSe]:AVERAge:TCONtrol

[[:SENSe]:AVERAge[:STATe](?)

Determines whether to turn averaging on or off.

Syntax [:SENSe]:AVERAge[:STATe] { OFF | ON | 0 | 1 }
[:SENSe]:AVERAge[:STATe]?

Arguments OFF or 0 turns off averaging.
ON or 1 turns on averaging.

Measurement Modes DEMADEM, TIMTRAN, TIMPULSE

Examples :SENSe:AVERAge:STATe ON
turns on averaging.

[[:SENSe]:AVERAge:TCONtrol(?)

Selects or queries the action when more than :AVERAge:COUNT measurement results are generated (TCONtrol is TerminalCONtrol).

Syntax [:SENSe]:AVERAge:TCONtrol { EXPonential | REPeat }
[:SENSe]:AVERAge:TCONtrol?

Arguments EXPonential continues the RMS (root-mean-square) average with an exponential weighting applied to old values using the setting of [:SENSe]:AVERAge:COUNT as the weighting factor.

REPeat clears average data and counter, and restarts the average process when :AVERAge:COUNT is reached.

Measurement Modes DEMADEM, TIMTRAN, TIMPULSE

Examples :SENSe:AVERAge:TCONtrol REPeat
repeats the averaging process.

Related Commands [:SENSe]:AVERAge:COUNT, [:SENSe]:AVERAge:TYPE

[:SENSe]:BSIZE Subgroup

The [:SENSe]:BSIZE command controls the block size (the number of frames in each contiguous acquisition).

NOTE. This subgroup is available in the Real Time S/A (real-time spectrum analysis), the Demod (modulation analysis), and the Time (time analysis) modes.

Command Tree

Header	Parameter
[:SENSe]	
:BSIZE	<numeric_value>

[:SENSe]:BSIZE(?)

Sets or queries the block size.

Syntax

```
[:SENSe]:BSIZE <value>
[:SENSe]:BSIZE?
```

Arguments

<value>::=<NR1> specifies the block size. The range depends on the trigger mode set with the :TRIGger[:SEQuence]:MODE command as shown in Table 2-43.

Table 2-43: Block size setting range

Trigger mode	Block size
AUTO	1 to 16000 (standard) / 64000 (Option 02)
NORMal	5 to 16000 (standard) / 64000 (Option 02)

Measurement Modes

SARTIME, DEMADeM, DEMDdEM, TIMCCDF, TIMTRAN, TImPULSE

Examples

```
:SENSe:BSIZE 8
sets the block size to 8.
```

Related Commands

```
:TRIGger[:SEQuence]:MODE
```

[[:SENSe]:CCDF Subgroup

The [[:SENSe]:CCDF commands set up the conditions related to the CCDF measurement.

NOTE. To use a command of this group, you must have selected *TIMCCDF* (CCDF measurement) in the *:INSTRument[:SElect]* command.

Command Tree	Header	Parameter
	[[:SENSe]	
	:CCDF	
	:BLOCK	<numeric_value>
	:CLEAr	
	:RMEasurement	
	:THReshold	<numeric_value>

[:SENSe] :CCDF :BLOCK (?)

Sets or queries the number of the block to measure in the CCDF analysis.

Syntax [:SENSe] :CCDF :BLOCK <value>
[:SENSe] :CCDF :BLOCK ?

Arguments <value>::=<NR1> specifies the block number. Zero represents the latest block.
Range: -M to 0 (M: Number of acquired blocks)

Measurement Modes TIMCCDF

Examples :SENSe:CCDF:BLOCK -5
sets the block number to -5.

[:SENSe] :CCDF :CLEAr (No Query Form)

Resets the CCDF measurement.

Syntax [:SENSe] :CCDF :CLEAr

Arguments None

Measurement Modes TIMCCDF

Examples :SENSe:CCDF:CLEAr
resets the CCDF measurement.

[:SENSe]:CCDF:RMEasurement (No Query Form)

Clears the CCDF accumulator and restarts the measurement.
This command is equivalent to the [:SENSe]:CCDF:CLEar command.

Syntax [:SENSe]:CCDF:RMEasurement

Arguments None

Measurement Modes TIMCCDF

Examples :SENSe:CCDF:RMEasurement
clears the CCDF accumulator and restarts the measurement.

Related Commands [:SENSe]:CCDF:CLEar

[:SENSe]:CCDF:THReshold(?)

Sets or queries the threshold which defines the samples to be included in the CCDF calculation.

Syntax [:SENSe]:CCDF:THReshold <value>
[:SENSe]:CCDF:THReshold?

Arguments <value>::=<NR1> specifies the threshold. Range: -250 to 130 dBm.

Measurement Modes TIMCCDF

Examples :SENSe:CCDF:THReshold 50dBm
sets the threshold to 50 dBm.

[:SENSe]:CFrequency Subgroup

The [:SENSe]:CFrequency commands set up the conditions related to the carrier frequency measurement.

Command Tree	Header	Parameter
	[:SENSe]	
	:CFrequency	
	:CRESolution	<numeric_value>

Prerequisites for Use

To use a command of this group, you must have run at least the following two commands:

1. Run the following command to set the measurement mode to S/A:

```
INSTRument[:SElect] { SANORMAL | SASGRAM | SARTIME }
```
2. Run one of the following commands to start the carrier frequency measurement:
 - To start the measurement with the default settings:

```
:CONFigure:SPECTrum:CFrequency
```
 - To start the measurement without modifying the current settings:

```
[:SENSe]:SPECTrum:MEASurement CFrequency
```

[:SENSe]:CFrequency:CRESolution(?)

Sets or queries the counter resolution for the carrier frequency measurement.

Syntax [:SENSe]:CFrequency:CRESolution <value>
 [:SENSe]:CFrequency:CRESolution?

Arguments <value>::=<NRf> specifies the counter resolution.
 Setting value (Hz): 0.001, 0.01, 0.1, 1, 10, 100, 1k, 10k, 100k, or 1M

Measurement Modes SANORMAL, SASGRAM, SARTIME

Examples :SENSe:CFrequency:CRESolution 1kHz
 sets the counter resolution to 1 kHz.

[:SENSe]:CHPower Subgroup

The [:SENSe]:CHPower commands set up the conditions related to the channel power measurement.

Command Tree	Header	Parameter
	[:SENSe]	
	:CHPower	
	:BANDwidth :BWIDTH	
	:INTEgration	<numeric_value>
	:FILTer	
	:COEFFicient	<numeric_value>
	:TYPE	RECTangle GAUSSian NYQuist RNYQuist

Prerequisites for Use To use a command of this group, you must have run at least the following two commands:

1. Run the following command to set the measurement mode to S/A:

```
INSTRument[:SElect] { SANORMAL | SASGRAM | SARTIME }
```

2. Run one of the following commands to start the channel power measurement:
 - To start the measurement with the default settings:
:CONFIgure:SPECTrum:CHPower
 - To start the measurement without modifying the current settings:
[:SENSe]:SPECTrum:MEASurement CHPower

[:SENSe]:CHPower:BANDwidth|:BWIDth:INTEgration(?)

Sets or queries the channel bandwidth for the channel power measurement (see Figure 2–18).

Syntax [:SENSe]:CHPower:BANDwidth|:BWIDth:INTEgration <value>

[:SENSe]:CHPower:BANDwidth|:BWIDth:INTEgration?

Arguments <value>::=<Nrf> specifies the channel bandwidth for the channel power measurement. Range: (Bin bandwidth) \times 8 to full span [Hz]. Refer to the *RSA3303A and RSA3308A User Manual* for the bin bandwidth.

Measurement Modes SANORMAL, SASGRAM, SARTIME

Examples :SENSe:CHPower:BANDwidth:INTEgration 2.5MHz
sets the channel bandwidth to 2.5 MHz.

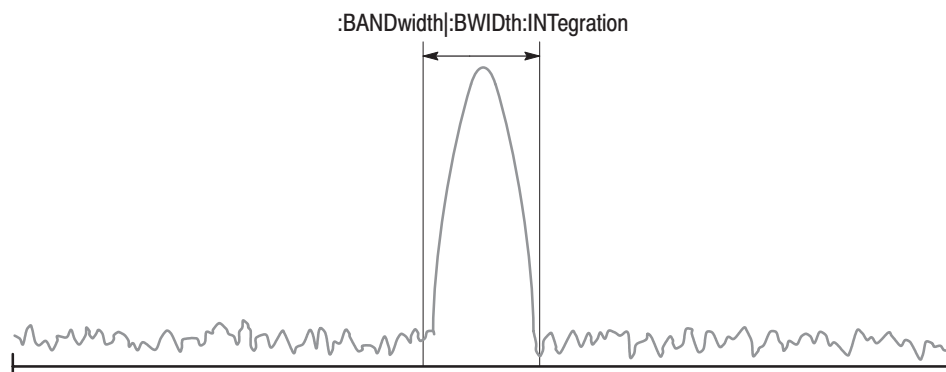

NOTE: Command header [:SENSe]:CHPower is omitted here.

Figure 2–18: Setting up the channel power measurement

[:SENSe]:CHPower:FILTer:COEFficient(?)

Sets or queries the roll-off rate of the filter for the channel power measurement when you have selected either NYQuist (Nyquist filter) or RNYQuist (Root Nyquist filter) in the [:SENSe]:CHPower:FILTer:TYPE command.

Syntax [:SENSe]:CHPower:FILTer:COEFficient <ratio>
 [:SENSe]:CHPower:FILTer:COEFficient?

Arguments <ratio>::=<NRf> specifies the roll-off rate of the filter for the channel power measurement. Range: 0.0001 to 1 (default: 0.5)

Measurement Modes SANORMAL, SASGRAM, SARTIME

Examples :SENSe:CHPower:FILTer:COEFficient 0.3
 sets the filter roll-off rate to 0.3.

Related Commands [:SENSe]:CHPower:FILTer:TYPE

[:SENSe]:CHPower:FILTer:TYPE(?)

Selects or queries the filter for the channel power measurement.

Syntax [:SENSe]:CHPower:FILTer:TYPE { RECTangle | GAUSSian | NYQuist
 | RNYQuist }
 [:SENSe]:CHPower:FILTer:TYPE?

Arguments RECTangle selects the rectangular filter.
 GAUSSian selects the Gaussian filter.
 NYQuist selects the Nyquist filter (default).
 RNYQuist selects the Root Nyquist filter.

Measurement Modes SANORMAL, SASGRAM, SARTIME

Examples :SENSe:CHPower:FILTer:TYPE RNYQuist
 selects the Root Nyquist filter.

[[:SENSe]:CNRatio Subgroup

The [[:SENSe]:CNRatio commands set up the conditions related to the carrier-to-noise ratio (C/N) measurement.

Command Tree	Header	Parameter
	[[:SENSe]	
	:CNRatio	
	:BANDwidth :BWIDth	
	:INTEgration	<frequency>
	:NOISe	<frequency>
	:FILTer	
	:COEFFicient	<numeric_value>
	:TYPE	RECTangle GAUSSian NYQuist RNYQuist
	:OFFSet	<frequency>

Prerequisites for Use

To use a command of this group, you must have run at least the following two commands:

1. Run the following command to set the measurement mode to S/A:

```
:INSTrument[:SElect] { SANORMAL | SASGRAM | SARTIME }
```
2. Run one of the following commands to start the C/N measurement:
 - To start the measurement with the default settings:

```
:CONFIgure:SPECTrum:CNRatio
```
 - To start the measurement without modifying the current settings:

```
[:SENSe]:SPECTrum:MEASurement CNRatio
```

[[:SENSe]:CNRatio:BANDwidth|:BWIDth:INTEgration(?)

Sets or queries the channel bandwidth for the C/N measurement (see Figure 2–19).

Syntax [:SENSe]:CNRatio:BANDwidth|:BWIDth:INTEgration <value>
[:SENSe]:CNRatio:BANDwidth|:BWIDth:INTEgration?

Arguments <value>::=<NRf> is the carrier bandwidth for the C/N measurement.
Range: (Bin bandwidth) × 8 to full span [Hz].
Refer to the *RSA3303A and RSA3308A User Manual* for the bin bandwidth.

Measurement Modes SANORMAL, SASGRAM, SARTIME

Examples :SENSe:CNRatio:BANDwidth:INTEgration 1MHz
sets the carrier bandwidth to 1 MHz.

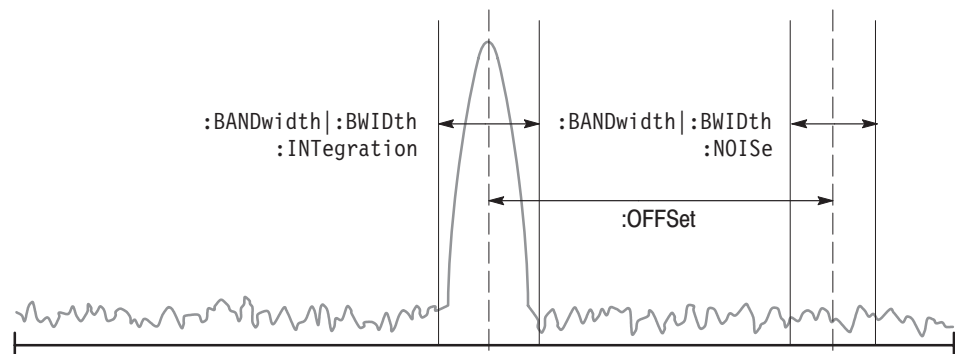

NOTE: Command header [:SENSe]:CNRatio is omitted here.

Figure 2-19: Setting up the C/N measurement

[:SENSe]:CNRatio:BANDwidth|:BWIDth:NOISe(?)

Sets or queries the noise bandwidth for the C/N measurement (see Figure 2–19).

Syntax [:SENSe]:CNRatio:BANDwidth|:BWIDth:NOISe <value>
 [:SENSe]:CNRatio:BANDwidth|:BWIDth:NOISe?

Arguments <value>::=<NRf> is the noise bandwidth for the C/N measurement.
 Range: (Bin bandwidth) × 8 to full span [Hz].
 Refer to the *RSA3303A and RSA3308A User Manual* for the bin bandwidth.

Measurement Modes SANORMAL, SASGRAM, SARTIME

Examples :SENSe:CNRatio:BANDwidth:NOISe 1.5MHz
 sets the noise bandwidth to 1.5 MHz.

[[:SENSe]:CNRatio:FILTer:COEFFicient(?)

Sets or queries the roll-off rate of the filter for the C/N measurement when you have selected either NYQuist (Nyquist filter) or RNYQuist (Root Nyquist filter) in the [:SENSe]:CNRatio:FILTer:TYPE command.

Syntax [:SENSe]:CNRatio:FILTer:COEFFicient <value>
 [:SENSe]:CNRatio:FILTer:COEFFicient?

Arguments <value>::=<NRF> is the filter roll-off rate. Range: 0.0001 to 1 (default: 0.5)

Measurement Modes SANORMAL, SASGRAM, SARTIME

Examples :SENSe:CNRatio:FILTer:COEFFicient 0.3
 sets the filter roll-off rate to 0.3.

Related Commands [:SENSe]:CNRatio:FILTer:TYPE

[[:SENSe]:CNRatio:FILTer:TYPE(?)

Selects or queries the filter for the C/N measurement.

Syntax [:SENSe]:CNRatio:FILTer:TYPE { RECTangle | GAUSSian | NYQuist |
 RNYQuist }
 [:SENSe]:CNRatio:FILTer:TYPE?

Arguments RECTangle selects the rectangular filter.
 GAUSSian selects the Gaussian filter.
 NYQuist selects the Nyquist filter (default).
 RNYQuist selects the Root Nyquist filter.

Measurement Modes SANORMAL, SASGRAM, SARTIME

Examples :SENSe:CNRatio:FILTer:TYPE RNYQuist
 selects the Root Nyquist filter.

[:SENSe]:CNRatio:OFFSet(?)

Sets or queries offset from the carrier to noise in the the C/N measurement (see Figure 2–19).

Syntax [:SENSe]:CNRatio:OFFSet <freq>
 [:SENSe]:CNRatio:OFFSet?

Arguments <freq>::=<NRf> specifies the offset frequency. Range: $-(\text{Span})/2$ to $+(\text{Span})/2$

Measurement Modes SANORMAL, SASGRAM, SARTIME

Examples :SENSe:CNRatio:OFFSet 5MHz
 sets the offset frequency to 5 MHz.

[[:SENSe]:CORRection Subgroup

The [[:SENSe]:CORRection commands control the amplitude correction. For details on the amplitude correction, refer to the *RSA3303A and RSA3308A User Manual*.

NOTE. This subgroup is available in the S/A (spectrum analysis) mode except real-time. You must have selected SANORMAL or SASGRAM with the :INSTRument[:SELEct] command to use a command in this subgroup but only [[:SENSe]:CORRection[:MAGNitude] command which is available in all the measurement modes.

Command Tree	Header	Parameter
	[[:SENSe]	
	:CORRection	
	:DATA	#<Num_digit><Num_byte> <Freq(1)><Amp1(1)> <Freq(2)><Amp1(2)>... <Freq(n)><Amp1(n)>
	:DELEte	
	:OFFSet	
	[:MAGNitude]	<numeric_value>
	:FREQency	<numeric_value>
	[:STATe]	
	:X	
	:SPACing	LINear LOGarithmic
	:Y	
	:SPACing	LINear LOGarithmic

[[:SENSe]:CORRection:DATA(?)]

Sets or queries the amplitude correction data.

Syntax [:SENSe]:CORRection:DATA #<Num_digit><Num_byte>
 <Freq(1)><Amp1(1)><Freq(2)><Amp1(2)>...<Freq(n)><Amp1(n)>
 [:SENSe]:CORRection:DATA?

Arguments <Num_digit> is the number of digits in <Num_byte>.
 <Num_byte> is the number of bytes of the data that follow.
 <Freq(n)> is the frequency at correction point in Hz.
 4-byte little endian floating-point format specified in IEEE 488.2
 <Amp1(n)> is the amplitude correction value at frequency <Freq(n)> in dB.
 4-byte little endian floating-point format specified in IEEE 488.2
 Enter the data that consists of pairs of the frequency and amplitude correction
 values (n: Max 3000).

Measurement Modes SANORMAL, SASGRAM

Examples :SENSe:CORRection:DATA #41024xxxx...
 sets the correction values at 1024 points.

[[:SENSe]:CORRection:DELeTe (No Query Form)]

Deletes all the amplitude correction data.

Syntax [:SENSe]:CORRection:DELeTe

Arguments None

Measurement Modes SANORMAL, SASGRAM

Examples :SENSe:CORRection:DELeTe
 deletes all the amplitude correction data.

[[:SENSe]:CORRection:OFFSet[:MAGNitude](?)

Sets or queries the amplitude offset value in the amplitude correction.

Syntax [:SENSe]:CORRection:OFFSet[:MAGNitude] <value>
 [:SENSe]:CORRection:OFFSet[:MAGNitude]?

Arguments <value>::=<NRf> specifies the amplitude offset value.
 Range: -200 to +200 dB.

Measurement Modes All

Examples :SENSe:CORRection:OFFSet:MAGNitude 10
 sets the amplitude offset value to 10 dB.

Related Commands [:SENSe]:CORRection:OFFSet:STATe

[[:SENSe]:CORRection:OFFSet:FREQuency(?)

Sets or queries the frequency offset value in the amplitude correction.

Syntax [:SENSe]:CORRection:OFFSet:FREQuency <value>
 [:SENSe]:CORRection:OFFSet:FREQuency?

Arguments <value>::=<NRf> specifies the frequency offset value.
 Range: -100 GHz to +100 GHz.

Measurement Modes SANORMAL, SASGRAM

Examples :SENSe:CORRection:OFFSet:FREQuency 10MHz
 sets the frequency offset value to 10 MHz.

Related Commands [:SENSe]:CORRection:OFFSet:STATe

[:SENSe]:CORRection[:STATe](?)

Determines whether to turn the amplitude correction on or off.

Syntax [:SENSe]:CORRection[:STATe] { OFF | ON | 0 | 1 }
[:SENSe]:CORRection[:STATe]?

Arguments OFF or 0 turns off the amplitude correction.
ON or 1 turns on the amplitude correction.

Measurement Modes SANORMAL, SASGRAM

Examples :SENSe:CORRection:STATe ON
turns on the amplitude correction.

[[:SENSe]:CORRection:X:SPACing(?)

Determines whether the horizontal, or frequency, scaling is linear or logarithmic for interpolation of amplitude correction data.

Syntax [:SENSe]:CORRection:X:SPACing { LINear | LOGarithmic }
[:SENSe]:CORRection:X:SPACing?

Arguments LINear selects the linear scale for the interpolation.
LOGarithmic selects the logarithmic scale for the interpolation.

Measurement Modes SANORMAL, SASGRAM

Examples :SENSe:CORRection:X:SPACing LINear
selects the linear scale for the interpolation.

[[:SENSe]:CORRection:Y:SPACing(?)

Determines whether the vertical, or amplitude, scaling is linear or logarithmic for interpolation of amplitude correction data.

Syntax [:SENSe]:CORRection:Y:SPACing { LINear | LOGarithmic }
[:SENSe]:CORRection:Y:SPACing?

Arguments LINear selects the linear scale for the interpolation.
LOGarithmic selects the logarithmic scale for the interpolation.

Measurement Modes SANORMAL, SASGRAM

Examples :SENSe:CORRection:Y:SPACing LINear
selects the linear scale for the interpolation.

[:SENSe]:DDEMod Subgroup (Option 21 Only)

The [:SENSe]:DDEMod commands set up the conditions related to the digital modulation analysis.

NOTE. To use a command from this group, you must have selected *DEMDDEM* (digital modulation analysis) in the *:INSTrument[:SElect]* command.

Command Tree	Header	Parameter
	[:SENSe]	
	:DDEMod	
	:BLOCk	<numeric_value>
	:CARRier	
	:OFFSet	<frequency>
	:SEARCh	<boolean>
	:DECode	NRZ MANChester MILLer
	:FDEVIation	<numeric_value>
	:AUTO	<boolean>
	:FILTer	
	:ALPHa	<numeric_value>
	:MEASurement	OFF RRCosine
	:REFerence	OFF RCOsine GAUSSian
	:FORMat	BPSK QPSK PS8P Q16P Q32P Q64P Q128P Q256P GMSK GFSK DQPSk OQPSk ASK FSK
	[:IMMediate]	
	:LENGth	<numeric_value>
	:MDEPth	<numeric_value>
	:AUTO	<boolean>
	:NLINearity	
	:COEFFicient	<numeric_value>
	:HDIVision	<numeric_value>
	:LSRegion	
	[:SET]	<numeric_value>
	:UNIT	RELative ABSolute
	:OFFSet	<numeric_value>
	:PRESet	OFF NADC PDC PHS TETRa GSM CDPD BLUetooth
	:SRATe	<numeric_value>

For the commands defining the analysis range, see the figure below. The analysis range is shown as a green line in the overview.

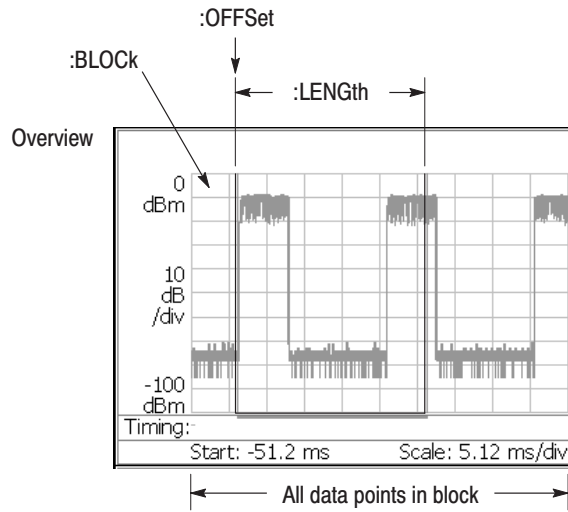

NOTE: Command header [:SENSe]:DDEMod is omitted here.

Figure 2-20: Defining the analysis range

[:SENSe]:DDEMod:BLOCK(?)

Sets or queries the number of the block to measure in the digital modulation analysis (see Figure 2–20).

Syntax [:SENSe]:DDEMod:BLOCK <number>

[:SENSe]:DDEMod:BLOCK?

Arguments <number>::=<NR1> specifies the block number. Zero represents the latest block.
Range: –M to 0 (M: Number of acquired blocks)

Measurement Modes DEMDDEM

Examples :SENSe:DDEMod:BLOCK -5
sets the block number to –5.

[:SENSe]:DDEMod:CARRier:OFFSet(?)

Sets or queries the carrier frequency offset in the digital modulation analysis when [:SENSe]:DDEMod:CARRier:SEARch is set to OFF.

Syntax [:SENSe]:DDEMod:CARRier:OFFSet <freq>

[:SENSe]:DDEMod:CARRier:OFFSet?

Arguments <frequency>::=<NR1> is the carrier frequency offset.
Range: –30 MHz to +30 MHz

Measurement Modes DEMDDEM

Examples :SENSe:DDEMod:CARRier:OFFSet 10MHz
sets the carrier frequency offset to 10 MHz.

Related Commands [:SENSe]:DDEMod:CARRier:SEARch

[:SENSe]:DDEMod:CARRier:SEARch(?)

Selects or queries whether to detect the carrier automatically in the digital modulation analysis.

Syntax [:SENSe]:DDEMod:CARRier:SEARch { OFF | ON | 0 | 1 }
[:SENSe]:DDEMod:CARRier:SEARch?

Arguments OFF or 0 specifies that the carrier is not detected automatically. To set it, use the [:SENSe]:DDEMod:CARRier:OFFSet command.
ON or 1 specifies that the carrier is detected automatically.

Measurement Modes DEMDDem

Examples :SENSe:DDEMod:CARRier:SEARch ON
specifies that the carrier is detected automatically.

Related Commands [:SENSe]:DDEMod:CARRier:OFFSet

[:SENSe]:DDEMod:DECode(?)

Selects or queries the method that is used to decode the data bits from each symbol choice.

NOTE. This command is valid when [:SENSe]:DDEMod:FORMat is ASK, FSK or GFSK.

Syntax [:SENSe]:DDEMod:DECode { NRZ | MANChester | MILLer }
[:SENSe]:DDEMod:DECode?

Arguments NRZ selects the NRZ (Non-Return to Zero) decoding.
MANChester selects the Manchester decoding.
MILLer selects the Miller decoding.

Measurement Modes DEMDDEM

Examples :SENSe:DDEMod:DECode NRZ
selects the NRZ decoding.

Related Commands [:SENSe]:DDEMod:FORMat

[[:SENSe]:DDEMod:FDEVIation(?)]

Sets or queries the frequency deviation to separate two states of an FSK or GFSK signal. This command is valid when [:SENSe]:DDEMod:FORMat is set to FSK or GFSK and [:SENSe]:DDEMod:FDEVIation:AUTO is set to OFF.

Syntax [:SENSe]:DDEMod:FDEVIation <value>
 [:SENSe]:DDEMod:FDEVIation?

Arguments <value>::=<NRf> sets the frequency deviation. Range: 0 to Span/2 Hz

Measurement Modes DEMDDEM

Examples :SENSe:DDEMod:FDEVIation 1MHz
 sets the frequency deviation to 1 MHz.

Related Commands [:SENSe]:DDEMod:FDEVIation:AUTO, [:SENSe]:DDEMod:FORMat

[:SENSe]:DDEMod:FDEVIation:AUTO(?)

Determines whether to detect automatically or set manually the frequency deviation used to distinguish between the two states of an FSK or GFSK signal. This command is valid when [:SENSe]:DDEMod:FORMat is set to FSK or GFSK.

Syntax [:SENSe]:DDEMod:FDEVIation:AUTO { OFF | ON | 0 | 1 }
[:SENSe]:DDEMod:FDEVIation:AUTO?

Arguments ON or 1 automatically calculates the frequency deviation for the analysis range and displays the value in the Frequency Deviation side key (default).
OFF or 0 sets the frequency deviation using the [:SENSe]:DDEMod:FDEVIation command.

Measurement Modes DEMDDEM

Examples :SENSe:DDEMod:FDEVIation:AUTO ON
automatically calculates the frequency deviation.

Related Commands [:SENSe]:DDEMod:FDEVIation, [:SENSe]:DDEMod:FORMat

[:SENSe]:DDEMod:FILTer:ALPHa(?)

Sets or queries the filter factor (α/BT) in the digital modulation analysis.

Syntax [:SENSe]:DDEMod:FILTer:ALPHa <value>
[:SENSe]:DDEMod:FILTer:ALPHa?

Arguments <value>::=<NRf> is the filter factor. Range: 0.0001 to 1.

Measurement Modes DEMDDEM

Examples :SENSe:DDEMod:FILTer:ALPHa 0.5
sets the filter factor to 0.5.

[[:SENSe]:DDEMod:FILTer:MEASurement(?)]

Selects or queries the measurement filter in the digital modulation analysis.

Syntax [:SENSe]:DDEMod:FILTer:MEASurement { OFF | RRCosine }
[:SENSe]:DDEMod:FILTer:MEASurement?

Arguments OFF specifies that no filter is used.
RRCosine selects the Root Raised Cosine filter.

Measurement Modes DEMDDEM

Examples :SENSe:DDEMod:FILTer:MEASurement RRCosine
selects the Root Raised Cosine filter as the measurement filter.

[[:SENSe]:DDEMod:FILTer:REFerence(?)]

Selects or queries the reference filter in the digital modulation analysis.

Syntax [:SENSe]:DDEMod:FILTer:REFerence { OFF | RCOSine | GAUSSian }
[:SENSe]:DDEMod:FILTer:REFerence?

Arguments OFF specifies that no filter is used.
RCOSine selects the Raised Cosine filter.
GAUSSian selects the Gaussian filter.

Measurement Modes DEMDDEM

Examples :SENSe:DDEMod:FILTer:REFerence RCOSine
selects the Raised Cosine filter as the reference filter.

[:SENSe]:DDEMod:FORMat(?)

Selects or queries the modulation system in the digital modulation analysis.

Syntax [:SENSe]:DDEMod:FORMat { BPSK | QPSK | PS8P | Q16P | Q32P | Q64P
| Q128P | Q256P | GMSK | GFSK | DQPSk | OQPSk | ASK | FSK }
[:SENSe]:DDEMod:FORMat?

Arguments Table 2–44 lists the arguments and corresponding modulations.

Table 2–44: Modulation selections

Argument	Modulation
BPSK	BPSK
QPSK	QPSK
PS8P	8PSK
Q16P	16QAM
Q32P	32QAM
Q64P	64QAM
Q128P	128QAM
Q256P	256QAM
GMSK	GMSK
GFSK	GFSK
DQPSk	1/4 π QPSK
OQPSk	OQPSK
ASK	ASK
FSK	FSK

Measurement Modes DEMDDEM

Examples :SENSe:DDEMod:FORMat DQPSk
selects 1/4 π QPSK modulation system.

[[:SENSe]:DDEMod[:IMMediate] (No Query Form)

Runs the digital demodulation calculation for the acquired data. To select the measurement item, use the [:SENSe]:DDEMod:MVIew:FORMat command. To acquire data, use the :INITiate command.

Syntax [:SENSe]:DDEMod[:IMMediate]

Arguments None

Measurement Modes DEMDDEM

Examples :SENSe:DDEMod:IMMediate
runs the digital demodulation calculation.

Related Commands :INITiate, [:SENSe]:DDEMod:MVIew:FORMat

[:SENSe]:DDEMod:LENGth(?)

Sets or queries the range for the digital modulation analysis (see Figure 2–20).

NOTE. The `[:SENSe]:DDEMod:LENGth?` query may return a value smaller than the default (7680) since the value is limited by the number of data points in the block.

Syntax `[:SENSe]:DDEMod:LENGth <value>`

`[:SENSe]:DDEMod:LENGth?`

Arguments `<value>::=<NR1>` specifies the analysis range by the number of data points. Range: 1 to $[1024 \times (\text{block size})]$ or $[8192-512=7680]$ whichever smaller. To set the block size, use the `[:SENSe]:BSIZE` command.

Measurement Modes DEMDDEM

Examples `:SENSe:DDEMod:LENGth 1000`
sets the measurement range to 1000 points.

Related Commands `[:SENSe]:BSIZE`

[:SENSe] :DDEMod :MDEPth (?)

Sets or queries the modulation depth to separate two states of an ASK signal. This command is valid when [:SENSe] :DDEMod :FORMat is set to ASK and [:SENSe] :DDEMod :MDEPth :AUTO is set to OFF.

Syntax [:SENSe] :DDEMod :MDEPth <value>
[:SENSe] :DDEMod :MDEPth ?

Arguments <value> : := <NRf> specifies the depth of modulation. Range: 0 to 100%

Measurement Modes DEMDDEM

Examples :SENSe :DDEMod :MDEPth 20
sets the modulation depth to 20%.

Related Commands [:SENSe] :DDEMod :FORMat, [:SENSe] :DDEMod :MDEPth :AUTO

[[:SENSe]:DDEMod:MDEPth:AUTO(?)]

Determines whether to detect automatically or set manually the modulation depth used to distinguish between the two states of an ASK signal. This command is valid when [:SENSe]:DDEMod:FORMat is set to ASK.

Syntax [:SENSe]:DDEMod:MDEPth:AUTO { OFF | ON | 0 | 1 }
[:SENSe]:DDEMod:MDEPth:AUTO?

Arguments ON or 1 automatically calculates the modulation depth for the analysis range and displays the value in the Modulation Depth side key (default).

OFF or 0 sets the modulation depth using the [:SENSe]:DDEMod:MDEPth command.

Measurement Modes DEMDDEM

Examples :SENSe:DDEMod:MDEPth:AUTO ON
automatically calculates the modulation depth.

Related Commands [:SENSe]:DDEMod:MDEPth, [:SENSe]:DDEMod:FORMat

[[:SENSe]:DDEMod:NLINearity:COEFFicient(?)

Sets or queries the maximum order of the best-fit curve polynomial in the AM/AM or AM/PM measurement. This command is valid when :DISPlay :DDEMod:MVIew:FORMat is set to AMAM, AMPM, DAMam or DAMPm.

Syntax [:SENSe]:DDEMod:NLINearity:COEFFicient <number>
 [:SENSe]:DDEMod:NLINearity:COEFFicient?

Arguments <number>::=<NR1> specifies the maximum order of the best-fit curve polynomial. Range: 0 to 15 (the default is 8)

Measurement Modes DEMDEM

Examples :SENSe:DDEMod:NLINearity:COEFFicient 15
 sets the maximum order to 15.

Related Commands :DISPlay:DDEMod:MVIew:FORMat

[[:SENSe]:DDEMod:NLINearity:HDIvision(?)

Sets or queries the horizontal interval between display points for the CCDF or PDF measurement in the digital modulation analysis. This command is valid when :DISPlay:DDEMod:MVIew:FORMat is set to CCDF or PDF.

Syntax [:SENSe]:DDEMod:NLINearity:HDIvision <value>
 [:SENSe]:DDEMod:NLINearity:HDIvision?

Arguments <value>::=<NRf> specifies the horizontal interval between display points. Range: 0.01 to 1 dB (the default is 0.1 dB)

Measurement Modes DEMDEM

Examples :SENSe:DDEMod:NLINearity:HDIvision 0.2
 sets the horizontal interval between display points to 0.2 dB.

Related Commands :DISPlay:DDEMod:MVIew:FORMat

[[:SENSe]:DDEMod:NLINearity:LSRegion[:SET](?)

Sets or queries the linear signal region (a region supposed to have an ideal characteristic) in the AM/AM and AM/PM measurements. This command is valid when :DISPlay:DDEMod:MVIew:FORMat is set to AMAM, AMPM, DAMam or DAMPm.

Syntax [:SENSe]:DDEMod:NLINearity:LSRegion[:SET] <value>
 [:SENSe]:DDEMod:NLINearity:LSRegion[:SET]?

Arguments <value>::=<Nrf> specifies the linear signal region.
 Range: –100 to 50 dB or dBm.

The unit is dB when [:SENSe]:DDEMod:NLINearity:LSRegion:UNIT is set to RELative, and dBm when ABSolute.

Measurement Modes DEMDDEM

Examples :SENSe:DDEMod:NLINearity:LSRegion:SET -10
 sets the linear signal region to –10 dB (or dBm).

Related Commands :DISPlay:DDEMod:MVIew:FORMat,
 [:SENSe]:DDEMod:NLINearity:LSRegion:UNIT

[[:SENSe]:DDEMod:NLINearity:LSRegion:UNIT(?)]

Selects or queries the unit to set the linear signal region in the AM/AM and AM/PM measurements. This command is valid when :DISPlay:DDEMod:MVIEw:FORMat is set to AMAM, AMPM, DAMam or DAMPm. Use the [:SENSe]:DDEMod:NLINearity:LSRegion[:SET] command to set the region.

Syntax [:SENSe]:DDEMod:NLINearity:LSRegion:UNIT { RELative | ABSolute }
[:SENSe]:DDEMod:NLINearity:LSRegion:UNIT?

Arguments RELative specifies the linear signal region in dB with a value relative to the maximum power measured in the analysis range (default).

ABSolute specifies the linear signal region with an absolute power in dBm.

Measurement Modes DEMDDDEM

Examples :SENSe:DDEMod:NLINearity:LSRegion:UNIT RELative
specifies the linear signal region in dB.

Related Commands :DISPlay:DDEMod:MVIEw:FORMat,
[:SENSe]:DDEMod:NLINearity:LSRegion[:SET]

[[:SENSe]:DDEMod:OFFSet(?)]

Sets or queries the measurement start position in the digital modulation analysis (see Figure 2–20).

NOTE. The [[:SENSe]:DDEMod:OFFSet? query may return a value greater than the default (0) since the value is limited by the trigger position in the block.

Syntax [[:SENSe]:DDEMod:OFFSet <value>

[[:SENSe]:DDEMod:OFFSet?

Arguments <value>::=<NR1> defines the measurement start position by the number of points. Range: 0 to $1024 \times (\text{Block size}) - 1$. To set the block size, use the [[:SENSe]:BSIZE command.

Measurement Modes DEMDDEM

Examples :SENSe:DDEMod:OFFSet 500
sets the measurement start position to point 500.

Related Commands [[:SENSe]:BSIZE

[:SENSe]:DDEMod:PRESet(?)

Selects or queries the communication standard in the digital modulation analysis. The analyzer is configured in accordance with the selected standard.

Syntax [:SENSe]:DDEMod:PRESet { OFF | NADC | PDC | PHS | TETRa | GSM
| CDPD | BLUetooth }
[:SENSe]:DDEMod:PRESet?

Arguments Table 2–45 lists the arguments and corresponding communication standards.

Table 2–45: Communication standard selections

Argument	Communication standard
OFF	No communication standard is selected.
NADC	NADC
PDC	PDC
PHS	PHS
TETRa	TETRA
GSM	GSM
CDPD	CDPD
BLUetooth	Bluetooth

Measurement Modes DEMDDEM

Examples :SENSe:DDEMod:PRESet PDC
selects PDC to configure the analyzer for the standard.

[:SENSe]:DDEMod:SRATe(?)

Sets or queries the symbol rate in the digital modulation analysis.

Syntax [:SENSe]:DDEMod:SRATe <value>
 [:SENSe]:DDEMod:SRATe?

Arguments <value>::=<NRf> specifies the symbol rate.
 Range: 1 to 32 Msps (symbols per second)

NOTE. Do not include the unit in the argument of this command. For example, if you want to specify 21 ksps for the symbol rate, use “21.0E3”, “21000”, or another equivalent representation.

Measurement Modes DEMDDEM

Examples :SENSe:DDEMod:SRATe 21.0E3
 sets the symbol rate to 21 ksps.

[[:SENSe]:EBWidth Subgroup

The [[:SENSe]:EBWidth commands set up the conditions related to the emission bandwidth (EBW) measurement.

Command Tree	Header	Parameter
	[[:SENSe]	
	:EBWidth	
	:XDB	<numeric_value>

Prerequisites for Use To use a command of this group, you must have run at least the following two commands:

1. Run the following command to set the measurement mode to S/A:

```
:INSTRument[:SElect] { SANORMAL | SASGRAM | SARTIME }
```

2. Run one of the following commands to start an EBW measurement:

- To start the measurement with the default settings:
:CONFigure:SPECTrum:EBWidth
- To start the measurement without modifying the current settings:
[[:SENSe]:SPECTrum:MEASurement EBWidth

[:SENSe]:EBWidth:XDB(?)

Sets or queries the level relative to the maximum peak at which the EBW is measured (see Figure 2–21).

Syntax [:SENSe]:EBWidth:XDB <rel_amp>

[:SENSe]:EBWidth:XDB?

Arguments <rel_amp>: :=<NRf> is the level at which the EBW is measured. Specify the amplitude relative to the maximum peak.
Range: –100 to –1 dB (default: –30 dB).

Measurement Modes SANORMAL, SASGRAM, SARTIME

Examples :SENSe:EBWidth:XDB –20
specifies that the EBW is measured at a level –20 dB lower than the maximum peak.

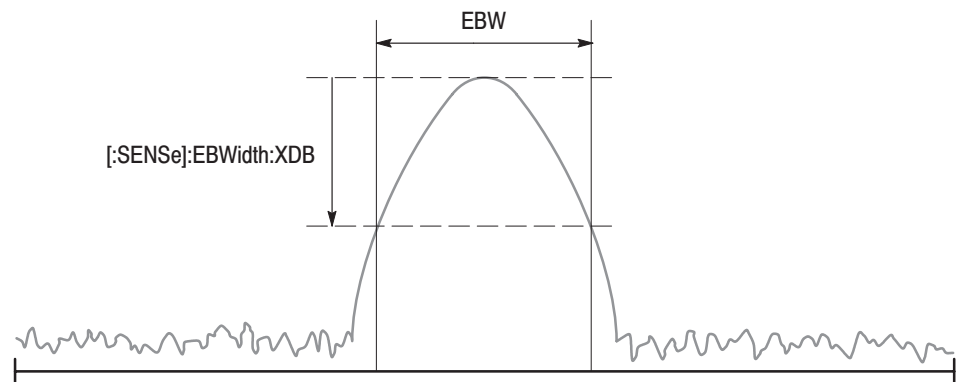

Figure 2–21: Setting up the EBW measurement

[[:SENSe]:FEED Subgroup

The [[:SENSe]:FEED commands select the input signal.

Command Tree	Header	Parameter
	[[:SENSe]	
	:FEED	RF IQ AREFERENCE

[[:SENSe]:FEED (No Query Form)

Selects the input signal: RF input or calibration signal.

Syntax [[:SENSe]:FEED { RF | IQ | AREFERENCE }

Arguments RF selects the RF input.
IQ selects the IQ input (Option 03 only).
AREFERENCE selects the internal calibration signal.

Measurement Modes All

Examples :SENSe:FEED RF
selects the RF input.

[:SENSe]:FREQuency Subgroup

The [:SENSe]:FREQuency commands set up the frequency-related conditions.

Command Tree	Header	Parameter
	[:SENSe]	
	:FREQuency	
	:BAND?	
	:CENTer	<frequency>
	:STEP	<frequency>
	:AUTO	<boolean>
	[:INCRement]	<frequency>
	:CHANnel	<numeric_value>
	:CTABle	
	:CATalog?	
	[:SELect]	<table_name>
	:SPAN	<frequency>
	:STARt	<frequency>
	:STOP	<frequency>

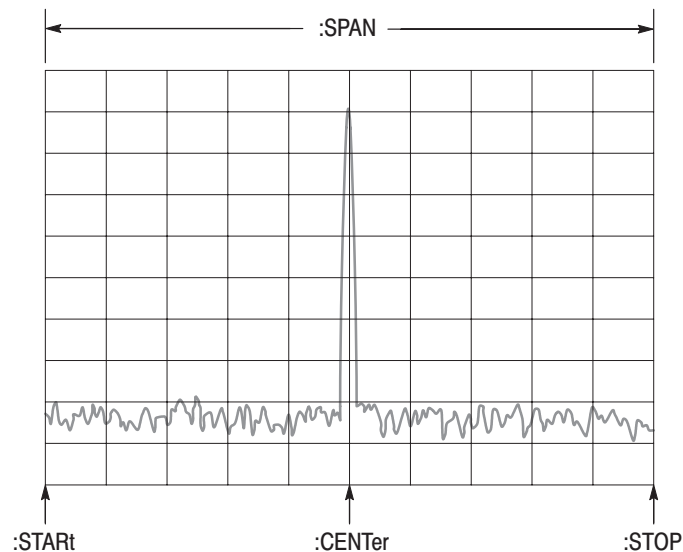

NOTE: Command header [:SENSe]:FREQuency is omitted here.

Figure 2–22: Setting frequency and span

[[:SENSe]:FREQuency:BAND? (Query Only)

Queries the measurement frequency band.

Syntax [:SENSe]:FREQuency:BAND?

Returns Table 2–46 shows the returned values and corresponding ranges:

Table 2–46: Measurement frequency bands

Argument	Frequency range
BAS	DC to 20 MHz
RF1B	15 MHz to 3 GHz (RSA3303A) 15 MHz to 3.5 GHz (RSA3308A)
RF2B	3.5 to 6.5 GHz (RSA3308A)
RF3B	5 to 8 GHz (RSA3308A)

Measurement Modes All

Examples :SENSe:FREQuency:BAND?
might return RF1B.

[:SENSe]:FREQUENCY:CENTer(?)

Sets or queries the center frequency.

Syntax [:SENSe]:FREQUENCY:CENTer <freq>
 [:SENSe]:FREQUENCY:CENTer?

Arguments <freq>::=<NRf> specifies the center frequency. For the setting range, refer to Table 2–46 on page 2–328.

Measurement Modes All

Examples :SENSe:FREQUENCY:CENTer 800MHz
 sets the center frequency to 800 MHz.

Related Commands [:SENSe]:FREQUENCY:BAND

[[:SENSe]:FREQuency:CENTer:STEP:AUTO(?)]

Determines whether to automatically set the step size (amount per click by which the up and down keys change a setting value) of the center frequency by the span setting.

Syntax [:SENSe]:FREQuency:CENTer:STEP:AUTO { OFF | ON | 0 | 1 }
[:SENSe]:FREQuency:CENTer:STEP:AUTO?

Arguments OFF or 0 specifies that the step size of the center frequency is not set automatically. To set it, use the [:SENSe]:FREQuency:CENTer:STEP[:INCRement] command.

ON or 1 specifies that the step size of the center frequency is set automatically by the span.

Measurement Modes All

Examples :SENSe:FREQuency:CENTer:STEP:AUTO ON
specifies that the step size of the center frequency is set automatically.

Related Commands [:SENSe]:FREQuency:CENTer:STEP[:INCRement]

[:SENSe]:FREQuency:CENTer:STEP[:INCRement](?)

Sets or queries the step size (amount per click by which the up and down keys change a setting value) of the center frequency when [:SENSe]:FREQuency:CENTer:STEP:AUTO is OFF.

NOTE. This command is effective only in remote operation. It does not affect the front panel setting of the frequency step size.

Syntax [:SENSe]:FREQuency:CENTer:STEP[:INCRement] <freq>
 [:SENSe]:FREQuency:CENTer:STEP[:INCRement]?

Arguments <freq>::=<NRf> is the step size of the center frequency.

Measurement Modes All

Examples :SENSe:FREQuency:CENTer:STEP:INCRement 10kHz
 sets the step size of the center frequency to 10 kHz.

Related Commands [:SENSe]:FREQuency:CENTer:STEP:AUTO

[:SENSe]:FREQuency:CHANnel(?)

Sets or queries a channel number in the channel table specified with the [:SENSe]:FREQuency:CTABLE[:SElect] command.

Syntax [:SENSe]:FREQuency:CHANnel <value>
 [:SENSe]:FREQuency:CHANnel?

Arguments <value>::=<NR1> specifies a channel number in the channel table.

Measurement Modes All

Examples :SENSe:FREQuency:CHANnel 10558
 sets the channel number to 10558 for the W-CDMA downlink analysis.

Related Commands [:SENSe]:FREQuency:CTABLE[:SElect]

[:SENSe]:FREQuency:CTABLE:CATalog? (Query Only)

Queries the available channel tables.

Syntax [:SENSe]:FREQuency:CTABLE:CATalog?

Returns <string> is the available channel table name(s). If more than one table is available, the table names are separated with comma. Refer to the [:SENSe]:FREQuency:CTABLE[:Select] command below for the table names.

Measurement Modes All

Examples :SENSe:FREQuency:CTABLE:CATalog?
 a partial return string may look like this:
 "CDMA2000 EU PAMR400-FL","CDMA2000 EU PAMR400-RL","CDMA2000 EU
 PAMR800-FL","CDMA2000 EU PAMR800-RL",...

Related Commands [:SENSe]:FREQuency:CTABLE[:SElect]

[[:SENSe]:FREQuency:CTABle[:SElect](?)

Selects the channel table. The query command returns the selected channel table.

Syntax [[:SENSe]:FREQuency:CTABle[:SElect] <table>

[[:SENSe]:FREQuency:CTABle[:SElect]?

Arguments <table>::=<string> specifies a channel table. The table name is represented with the communication standard name followed by “-FL” (forward link), “-RL” (reverse link), “-UL” (uplink), or “-DL” (downlink).

The following channel tables are available:

None (does not use channel tables)	
CDMA2000 EU PAMR400-FL	CDMA2000 EU PAMR400-RL
CDMA2000 EU PAMR800-FL	CDMA2000 EU PAMR800-RL
CDMA2000 GSM BAND 1-FL	CDMA2000 GSM BAND 1-RL
CDMA2000 GSM BAND 2-FL	CDMA2000 GSM BAND 2-RL
CDMA2000 IMT2000-FL	CDMA2000 IMT2000-RL
CDMA2000 JTACS BAND-FL	CDMA2000 JTACS BAND-RL
CDMA2000 KOREA PCS-FL	CDMA2000 KOREA PCS-RL
CDMA2000 N.A. 700MHz Cellular-FL	
CDMA2000 N.A. 700MHz Cellular-RL	
CDMA2000 N.A. Cellular-FL	CDMA2000 N.A. Cellular-RL
CDMA2000 N.A. PCS-FL	CDMA2000 N.A. PCS-RL
CDMA2000 NMT450 20k-FL	CDMA2000 NMT450 20k-RL
CDMA2000 NMT450 25k-FL	CDMA2000 NMT450 25k-RL
CDMA2000 SMR800-FL	CDMA2000 SMR800-RL
CDMA2000 TACS BAND-FL	CDMA2000 TACS BAND-RL
DCS1800-DL	DCS1800-UL
GSM850-DL	GSM850-UL
GSM900-DL	GSM900-UL
NMT450-DL	NMT450-UL
PCS1900-DL	PCS1900-UL
W-CDMA-DL	W-CDMA-UL

The table name must be within quotation marks for the argument.

Measurement Modes All

Examples :SENSe:FREQuency:CTABle:SElect "W-CDMA-DL"
selects the W-CDMA downlink channel table.

Related Commands [[:SENSe]:FREQuency:CTABle:CATalog?

[:SENSe]:FREQUency:SPAN(?)

Sets or queries the span.

NOTE. There are the following relationships among the center, start, and stop frequencies and the span; they are set interlinked manner:

$$(\text{Stop frequency} + \text{Start frequency}) / 2 = \text{Center frequency}$$

$$\text{Stop frequency} - \text{Start frequency} = \text{Span}$$

When you set one of these, all the other settings are automatically changed correspondingly.

Syntax [:SENSe]:FREQUency:SPAN <freq>

[:SENSe]:FREQUency:SPAN?

Arguments <freq> ::= <NRf> specifies the span. The valid range depends on the measurement mode as listed in Table 2–47:

Table 2–47: Span setting

Measurement mode	Frequency band	Setting range
SANORMAL SASGRAM	RF	50 Hz to 3 GHz (continuous)
	Baseband	50 Hz to 20 MHz (continuous)
Other than above	RF	100 Hz to 10 MHz (1-2-5 sequence) and 15 MHz
	Baseband	100 Hz to 20 MHz (1-2-5 sequence)

Measurement Modes All

Examples :SENSe:FREQUency:SPAN 1MHz
sets the span to 1 MHz.

Related Commands [:SENSe]:FREQUency:CENTer, [:SENSe]:FREQUency:START,
[:SENSe]:FREQUency:STOP

[:SENSe] :FREQuency :START (?)

Sets or queries the start frequency.

Syntax [:SENSe] :FREQuency :START <freq>

[:SENSe] :FREQuency :START?

Arguments <freq> : = <NRf> specifies the start frequency. For the setting range, refer to Table 2–46 on page 2–328.

Measurement Modes SANORMAL, SASGRAM

Examples :SENSe:FREQuency:START 800MHz
sets the start frequency to 800 MHz.

Related Commands [:SENSe] :FREQuency :CENTer, [:SENSe] :FREQuency :SPAN,
[:SENSe] :FREQuency :STOP

[:SENSe] :FREQuency :STOP (?)

Syntax [:SENSe] :FREQuency :STOP <freq>

[:SENSe] :FREQuency :STOP?

Arguments <freq> : = <NRf> specifies the stop frequency. For the setting range, refer to Table 2–46 on page 2–328.

Measurement Modes SANORMAL, SASGRAM

Examples :SENSe:FREQuency:STOP 1GHz
sets the stop frequency to 1 GHz.

Related Commands [:SENSe] :FREQuency :CENTer, [:SENSe] :FREQuency :SPAN,
[:SENSe] :FREQuency :START

[[:SENSe]:OBWidth Subgroup

The [[:SENSe]:OBWidth commands set the conditions related to the occupied bandwidth (OBW) measurement.

Command Tree	Header	Parameter
	[SENSe]	
	:OBWidth	
	:PERCent	<numeric_value>

Prerequisites for Use To use a command of this group, you must have run at least the following two commands:

1. Run the following command to set the measurement mode to S/A:

```
:INSTRument[:SElect] { SANORMAL | SASGRAM | SARTIME }
```

2. Run one of the following commands to start the OBW measurement:

- To start the measurement with the default settings:
:CONFigure:SPECTrum:OBWidth
- To start the measurement without modifying the current settings:
[:SENSe]:SPECTrum:MEASurement OBWidth

[:SENSe]:OBWidth:PERCent(?)

Sets or queries the occupied bandwidth for the OBW measurement.

Syntax [:SENSe]:OBWidth:PERCent <value>
 [:SENSe]:OBWidth:PERCent?

Arguments <value>::=<NRf> specifies the occupied bandwidth.
 Range: 80 to 99.99% (default: 99%)

Measurement Modes SANORMAL, SASGRAM, SARTIME

Examples :SENSe:OBWidth:PERCent 95
 sets the occupied bandwidth to 95%.

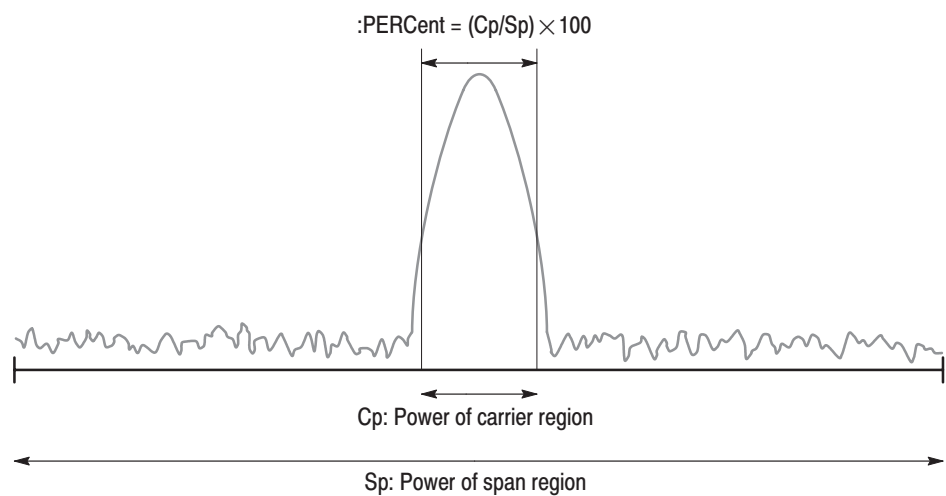

NOTE: The command header [:SENSe]:OBWidth is omitted here.

Figure 2-23: Setting up the OBW measurement

[[:SENSe]:PULSe Subgroup

The [[:SENSe]:PULSe commands set up the conditions related to the pulse characteristics analysis.

NOTE. To use a command from this group, you must have selected *TIMPULSE* (pulse characteristics analysis) in the *:INSTrument[:SELEct]* command.

Command Tree	Header	Parameter
	[[:SENSe]	
	:PULSe	
	:BLOCK	
	:CHPower	
	:BANDwidth BWIDth	
	:INTEgration	<numeric_value>
	:CRESolution	<numeric_value>
	:EBWidth	
	:XDB	<numeric_value>
	:FFT	
	:COEFFicient	<numeric_value>
	:WINDow	
	[:TYPE]	NYQuist BH4B
	:FILTer	
	:BANDwidth BWIDth	<numeric_value>
	:COEFFicient	<numeric_value>
	:MEASurement	OFF GAUSSian
	:FREQuency	
	:OFFSet	<numeric_value>
	:RECOvery	FIRST USER OFF
	[:IMMediate]	
	:OBWidth	
	:PERCent	<numeric_value>
	:PTOFFset	<numeric_value>
	:THReshold	<numeric_value>

[[:SENSe]:PULSe:BLOCK(?)]

Sets or queries the number of the block to measure in the pulse characteristics analysis.

Syntax [[:SENSe]:PULSe:BLOCK <value>

[[:SENSe]:PULSe:BLOCK?

Arguments <value>::=<NR1> specifies the block number. Zero represents the latest block. Range: –M to 0 (M: the number of acquired blocks)

Measurement Modes TIMPULSE

Examples :SENSe:PULSe:BLOCK –5
sets the block number to –5.

[[:SENSe]:PULSe:CHPower:BANDwidth|:BWIDth:INTEgration(?)]

Sets or queries the channel bandwidth for the channel power measurement in the pulse characteristics analysis.

Syntax [[:SENSe]:PULSe:CHPower:BANDwidth|:BWIDth:INTEgration <value>

[[:SENSe]:PULSe:CHPower:BANDwidth|:BWIDth:INTEgration?

Arguments <value>::=<NRf> is the channel bandwidth for the channel power measurement. Range: (Bin bandwidth) × 8 to full span [Hz]. Refer to the *RSA3303A and RSA3308A User Manual* for the bin bandwidth.

Measurement Modes TIMPULSE

Examples :SENSe:PULSe:CHPower:BANDwidth:INTEgration 1.5MHz
sets the channel bandwidth to 1.5 MHz.

[[:SENSe]:PULSe:CRESolution(?)

Sets or queries the frequency measurement resolution in the pulse characteristics analysis.

Syntax [:SENSe]:PULSe:CRESolution <value>

[:SENSe]:PULSe:CRESolution?

Arguments <value>::={ 1 | 10 | 100 | 1k | 10k | 100k | 1M } [Hz] specifies the frequency measurement resolution.

Measurement Modes TIMPULSE

Examples :SENSe:PULSe:CRESolution 1kHz
sets the frequency measurement resolution to 1 kHz.

[[:SENSe]:PULSe:EBWidth:XDB(?)

Sets or queries the level relative to the maximum peak at which the EBW is measured in the pulse characteristics analysis. Refer to the [:SENSe]:EBWidth:XDB command on page 2–325.

Syntax [:SENSe]:PULSe:EBWidth:XDB <value>

[:SENSe]:PULSe:EBWidth:XDB?

Arguments <value>::=<NRf> is the level at which the EBW is measured. Specify the amplitude relative to the maximum peak.
Range: –100 to –1 dB (default: –30 dB)

Measurement Modes TIMPULSE

Examples :SENSe:PULSe:EBWidth:XDB –20
specifies that the EBW is measured at a level –20 dB lower than the maximum peak.

Related Commands [:SENSe]:EBWidth:XDB

[:SENSe]:PULSe:FFT:COEFFicient(?)

Sets or queries the roll-off ratio when the FFT window type is Nyquist in the pulse characteristics analysis.

Syntax [:SENSe]:PULSe:FFT:COEFFicient <value>
 [:SENSe]:PULSe:FFT:COEFFicient?

Arguments <value>::=<NRf> specifies the roll-off ratio. Range: 0.0001 to 1.0 (default: 0.2)

Measurement Modes TIMPULSE

Examples :SENSe:PULSe:FFT:COEFFicient 0.5
 sets the roll-off ratio to 0.5.

Related Commands [:SENSe]:PULSe:FFT:WINDow[:TYPE]

[:SENSe]:PULSe:FFT:WINDow[:TYPE](?)

Selects or queries the FFT window type in the pulse characteristics analysis.

Syntax [:SENSe]:PULSe:FFT:WINDow[:TYPE] { NYQuist | BH4B }
 [:SENSe]:PULSe:FFT:WINDow[:TYPE]?

Arguments NYQuist selects the Nyquist window.
 BH4B selects the Blackman-Harris 4B type window.

Measurement Modes TIMPULSE

Examples :SENSe:PULSe:FFT:WINDow:TYPE NYQuist
 selects the Nyquist window.

[[:SENSe]:PULSe:FILTer:BA NDwidth|BWIDth(?)

Sets or queries the bandwidth of the time measurement filter in the pulse characteristics analysis.

Syntax [:SENSe]:PULSe:FILTer:BA NDwidth|BWIDth <value>

[:SENSe]:PULSe:FILTer:BA NDwidth|BWIDth?

Arguments <value>::=<NRf> specifies the bandwidth of the time measurement filter.
Range: Span/10 to full span.

Measurement Modes TIMPULSE

Examples :SENSe:PULSe:FILTer:BA NDwidth 1MHz
sets the bandwidth of the time measurement filter to 1 MHz.

[[:SENSe]:PULSe:FILTer:COEFFicient(?)

Sets or queries the α /BT value for the measurement filter when [:SENSe]:PULSe:FILTer:MEASurement is set to GAUSSian.

Syntax [:SENSe]:PULSe:FILTer:COEFFicient <value>

[:SENSe]:PULSe:FILTer:COEFFicient?

Arguments <value>::=<NRf> sets the α /BT value for the Gaussian measurement filter.
Range: 0.0001 to 1 (default: 0.35)

Measurement Modes TIMPULSE

Examples :SENSe:PULSe:FILTer:COEFFicient 0.5
sets the α /BT value to 0.5.

Related Commands [:SENSe]:PULSe:FILTer:MEASurement

[[:SENSe]:PULSe:FILTer:MEASurement(?)]

Selects or queries the measurement filter for the time measurement in the pulse characteristics analysis.

Syntax [:SENSe]:PULSe:FILTer:MEASurement { OFF | GAUSSian }
 [:SENSe]:PULSe:FILTer:MEASuerment?

Arguments OFF specifies that no measurement filter is used.
 GAUSSian selects the Gaussian filter.

Measurement Modes TIMPULSE

Examples :SENSe:PULSe:FILTer:MEASurement GAUSSian
 selects the Gaussian filter.

[[:SENSe]:PULSe:FREQuency:OFFSet(?)]

Sets or queries the frequency offset for the pulse-pulse phase and the frequency deviation measurements in the pulse characteristics analysis.

This command is valid when [:SENSe]:PULSe:FREQuency:RECOvery is set to USER. This query command is valid when [:SENSe]:PULSe:FREQuency:RECOvery is set to FIRSt or USER.

Syntax [:SENSe]:PULSe:FREQuency:OFFSet <value>
 [:SENSe]:PULSe:FREQuency:OFFSet?

Arguments <value>::=<NRf> specifies the frequency offset. Range: -10 to +10 MHz

Measurement Modes TIMPULSE

Examples :SENSe:PULSe:FREQuency:OFFSet 5MHz
 sets the frequency offset to 5 MHz.

Related Commands [:SENSe]:PULSe:FREQuency:RECOvery

[[:SENSe]:PULSe:FREQuency:RECovery(?)

Selects or queries the frequency recovery for the pulse-pulse phase and the frequency deviation measurements in the pulse characteristics analysis.

Syntax [:SENSe]:PULSe:FREQuency:RECovery { FIRSt | USER | OFF }
[:SENSe]:PULSe:FREQuency:RECovery?

Arguments FIRSt specifies that frequency correction is performed for all pulses based on the frequency error value calculated from the first pulse included in the analysis range. The calculated frequency error is shown in the Frequency Offset side key.

USER specifies that all pulses are corrected by the value set up by the [:SENSe]:PULSe:FREQuency:OFFSet command.

OFF disables frequency correction.

Measurement Modes TIMPULSE

Examples :SENSe:PULSe:FREQuency:RECovery FIRSt
specifies that frequency correction is performed using the first pulse.

Related Commands [:SENSe]:PULSe:FREQuency:OFFSet

[[:SENSe]:PULSe[:IMMediate] (No Query Form)

Runs calculation for acquired data in the pulse characteristics analysis.
To acquire data, use the :INITiate command.

Syntax [:SENSe]:PULSe[:IMMediate]

Arguments None

Measurement Modes TIMPULSE

Examples :SENSe:PULSe:IMMediate
runs calculation for acquired data.

Related Commands :INITiate

[[:SENSe]:PULSe:OBWidth:PERcent(?]

Sets or queries OBW (Occupied Bandwidth) for the OBW measurement in the pulse characteristics analysis.

Syntax [:SENSe]:PULSe:OBWidth:PERcent <value>

[:SENSe]:PULSe:OBWidth:PERcent?

Arguments <value>::=<NRf> specifies the occupied bandwidth.
Range: 80 to 99.9% (default: 99%).

Measurement Modes TIMPULSE

Examples :SENSe:PULSe:OBWidth:PERCent 95
sets the occupied bandwidth to 95%.

[[:SENSe]:PULSe:PTOffset(?)]

Sets or queries the time offset for the pulse-pulse phase measurement point.

Syntax [:SENSe]:PULSe:PTOffset <value>
 [:SENSe]:PULSe:PTOffset?

Arguments <value>::=<NRf> specifies the time offset. Range: 0 to 1 s (the default is 0)
The default value is 0 (zero), that is, the measurement point is at the beginning of the pulse-on time.

Measurement Modes TIMPULSE

Examples :SENSe:PULSe:PTOffset 1.5m
Sets the time offset to 1.5 ms.

[[:SENSe]:PULSe:THReshold(?)]

Sets or queries the threshold level to detect pulses in acquired data.

Syntax [:SENSe]:PULSe:THReshold <value>
 [:SENSe]:PULSe:THReshold?

Arguments <value>::=<NRf> specifies the threshold level.
Range: -100 to 0 dBc (the default is -3 dBc)

Measurement Modes TIMPULSE

Examples :SENSe:PULSe:THReshold -20
sets the threshold level to -20 dBc.

[:SENSe]:ROSCillator Subgroup

The [:SENSe]:ROSCillator commands set up the reference oscillator.

Command Tree	Header	Parameter
	[:SENSe]	
	:ROSCillator	
	:SOURce	INTerna1 EXTerna1

[:SENSe]:ROSCillator:SOURce(?)

Selects or queries the reference oscillator.

Syntax [:SENSe]:ROSCillator:SOURce { INTerna1 | EXTerna1 }
[:SENSe]:ROSCillator:SOURce?

Arguments INTerna1 selects the internal reference oscillator.
EXTerna1 selects the external reference oscillator. Connect it to the REF IN connector on the rear panel.

Measurement Modes All

Examples :SENSe:ROSCillator:SOURce EXTerna1
selects the external reference oscillator.

[[:SENSe]:SPECTrum Subgroup

The [[:SENSe]:SPECTrum commands set up the conditions related to the spectrum measurement in the S/A (spectrum analysis) mode.

Command Tree	Header	Parameter
	[[:SENSe]	
	:SPECTrum	
	:AVERage	
	:CLEar	
	:COUNT	<numeric_value>
	[:STATE]	<boolean>
	TYPE	RMS MAXimum MINimum
	:BANDwidth :BWIDTH	
	[:RESolution]	<numeric_value>
	:AUTO	<boolean>
	:STATE	<boolean>
	:DETEctor	
	[:FUNction]	NEGative POSitive PNEGative
	:FILTer	
	:COEFFicient	<numeric_value>
	:TYPE	RECTangle GAUSSian NYQuist RNYQuist
	:FFT	
	:ERESolution	<boolean>
	:LENGth	<numeric_value>
	:START	<numeric_value>
	:WINDow	
	[:TYPE]	BH3A BH3B BH4A BH4B BLACKman HAMMING HANNing PARZen ROSEnfield WELCh SLOBE SCUBed ST04 FLATtop RECT
	:FRAME	<numeric_value>
	:MEASurement	OFF CHPower ACPower OBWidth EBWidth CNRatio CFRequency

[:SENSe] :SPEcTrum :AVERAge :CLEAr (No Query Form)

Clears average data and counter, and restarts the average process.

Syntax [:SENSe] :SPEcTrum :AVERAge :CLEAr

Arguments None

Measurement Modes SANORMAL, SASGRAM

Examples :SENSe :SPEcTrum :AVERAge :CLEAr
Clears average data and counter, and restarts the average process.

[:SENSe] :SPEcTrum :AVERAge :COUNT(?)

Sets or queries the number of traces to combine using the :TYPE setting (refer to page 2–350).

Syntax [:SENSe] :SPEcTrum :AVERAge :COUNT <value>
[:SENSe] :SPEcTrum :AVERAge :COUNT?

Arguments <value>::=<NR1> is the number of traces to combine for averaging.
Range: 1 to 10000 (default: 20)

Measurement Modes SANORMAL, SASGRAM

Examples :SENSe :SPEcTrum :AVERAge :COUNT 64
sets the average count to 64.

Related Commands [:SENSe] :SPEcTrum :AVERAge :TYPE

[[:SENSe]:SPEctrum:AVERage[:STATe](?)

Determines whether to turn averaging on or off.

Syntax [:SENSe]:SPEctrum:AVERage[:STATe] { OFF | ON | 0 | 1 }
[:SENSe]:SPEctrum:AVERage[:STATe]?

Arguments OFF or 0 turns off averaging.
ON or 1 turns on averaging.

Measurement Modes SANORMAL, SASGRAM

Examples :SENSe:SPEctrum:AVERage:STATe ON
turns on averaging.

[[:SENSe]:SPEctrum:AVERage:TYPE(?)

Selects or queries the type of averaging.

Syntax [:SENSe]:SPEctrum:AVERage:TYPE { RMS | MAXimum | MINimum }
[:SENSe]:SPEctrum:AVERage:TYPE?

Arguments RMS performs the average process with RMS (root-mean-square).
MAXimum retains the maximum value at each data point on the waveform.
MINimum retains the minimum value at each data point on the waveform.

Measurement Modes SANORMAL, SASGRAM

Examples :SENSe:SPEctrum:AVERage:TYPE RMS
performs the average process with RMS.

[[:SENSe]:SPECtrum:BANDwidth]:BWIDth[:RESolution](?)

Sets or queries the resolution bandwidth (RBW) when [:SENSe]:SPECtrum:BANDwidth]:BWIDth[:RESolution]:AUTO is set to Off.

Syntax [:SENSe]:SPECtrum:BANDwidth]:BWIDth[:RESolution] <freq>
[:SENSe]:SPECtrum:BANDwidth]:BWIDth[:RESolution]?

Arguments <freq>::=<Nrf> specifies the RBW.
For the setting range, refer to Table D–2 in *Appendix D*.

Measurement Modes SANORMAL, SASGRAM

Examples :SENSe:SPECtrum:BANDwidth:RESolution 80kHz
sets the RBW to 80 kHz.

[[:SENSe]:SPECtrum:BANDwidth]:BWIDth[:RESolution]:AUTO(?)

Determines whether to automatically set the resolution bandwidth (RBW) by the span setting.

Syntax [:SENSe]:SPECtrum:BANDwidth]:BWIDth[:RESolution]:AUTO { OFF | ON
| 0 | 1 }
[:SENSe]:SPECtrum:BANDwidth]:BWIDth[:RESolution]:AUTO?

Arguments OFF or 0 specifies that the RBW is not set automatically. To set it, use the [:SENSe]:SPECtrum:BANDwidth]:BWIDth[:RESolution] command.

ON or 1 specifies that the RBW is set automatically.

Measurement Modes SANORMAL, SASGRAM

Examples :SENSe:SPECtrum:BANDwidth:RESolution:AUTO ON
specifies that the RBW is set automatically.

Related Commands :INSTRument[:SElect]

[[:SENSe]:SPECTrum:BANDwidth]:BWIDth:STATe(?)

Determines whether to perform the resolution bandwidth (RBW) process.

Syntax [:SENSe]:SPECTrum:BANDwidth]:BWIDth:STATe { OFF | ON | 0 | 1 }
[:SENSe]:SPECTrum:BANDwidth]:BWIDth:STATe?

Arguments OFF or 0 specifies that the RBW process is not performed so that a spectrum immediately after the FFT process is displayed on screen.
ON or 1 specifies that the RBW process is performed.

Measurement Modes SANORMAL, SASGRAM

Examples :SENSe:SPECTrum:BANDwidth:STATe ON
specifies that the resolution bandwidth process is performed.

[[:SENSe]:SPECTrum:DETector[:FUNction](?)

Selects or queries the display detector (method to be used for decimating traces to fit the available horizontal space on screen).

The number of horizontal pixel positions on screen is generally smaller than that of waveform data points. When actually displayed, the waveform data is therefore thinned out according to the number of horizontal pixel positions which can be displayed. For the details, refer to the *RSA3303A and RSA3308A User Manual*.

Syntax [:SENSe]:SPECTrum:DETector[:FUNction] { NEGative | POSitive
 | PNEGative }

[:SENSe]:SPECTrum:DETector[:FUNction]?

Arguments NEGative shows the minimum value of the data corresponding to each horizontal pixel position.

POSitive shows the maximum value of the data corresponding to each horizontal pixel position.

PNEGative draws a line connecting the maximum and minimum points of the data corresponding to each horizontal pixel position.

Measurement Modes SANORMAL, SASGRAM

Examples :SENSe:SPECTrum:DETector:FUNction PNEGative
displays waveform drawing a line that connects the maximum and minimum points of the data for each pixel.

[[:SENSe]:SPECTrum:FILTer:COEFFicient(?)

Sets or queries the roll-off rate of the RBW filter when you have selected either NYQuist (Nyquist filter) or RNYQuist (Root Nyquist filter) in the [:SENSe]:SPECTrum:FILTer:TYPE command.

Syntax [:SENSe]:SPECTrum:FILTer:COEFFicient <ratio>
 [:SENSe]:SPECTrum:FILTer:COEFFicient?

Arguments <ratio>::=<NRf> specifies the roll-off rate. Range: 0 to 1.

Measurement Modes SANORMAL, SASGRAM

Examples :SENSe:SPECTrum:FILTer:COEFFicient 0.5
 sets the RBW filter roll-off rate to 0.5.

Related Commands [:SENSe]:SPECTrum:FILTer:TYPE

[[:SENSe]:SPECTrum:FILTer:TYPE(?)

Selects or queries the RBW filter.

Syntax [:SENSe]:SPECTrum:FILTer:TYPE { RECTangle | GAUSSian | NYQuist
 | RNYQuist }
 [:SENSe]:SPECTrum:FILTer:TYPE?

Arguments RECTangle selects the rectangular filter.
 GAUSSian selects the Gaussian filter.
 NYQuist selects the Nyquist filter (default).
 RNYQuist selects the Root Nyquist filter.

Measurement Modes SANORMAL, SASGRAM

Examples :SENSe:SPECTrum:FILTer:TYPE NYQuist
 selects the Nyquist filter for RBW.

[:SENSe]:SPEcTrum:FFT:ERESolution(?)

Determines whether to enable the extended resolution that eliminates the limit on the number of FFT points (it is normally limited internally).

Syntax [:SENSe]:SPEcTrum:FFT:ERESolution { OFF | ON | 0 | 1 }
[:SENSe]:SPEcTrum:FFT:ERESolution?

Arguments OFF or 0 disables the extended resolution. The number of FFT points is limited internally.

ON or 1 allows you to set the number of FFT points up to 65536. Use the [:SENSe]:SPEcTrum:FFT:LENGth command to set the number.

NOTE. *It is recommended to keep the extended resolution off as its default condition.*

Measurement Modes All S/A modes except SARTIME

Examples :SENSe:SPEcTrum:FFT:ERESolution ON
enables the extended resolution.

Related Commands [:SENSe]:SPEcTrum:FFT:LENGth

[[:SENSe]:SPECTrum:FFT:LENGth(?)

Sets or queries the number of FFT points. This command is valid when [:SENSe]:SPECTrum:BANDwidth[:BWIDth:STATe] is OFF.

Syntax [:SENSe]:SPECTrum:FFT:LENGth <value>

[:SENSe]:SPECTrum:FFT:LENGth?

Arguments <value>::=<NR1> sets the number of FFT points.
Range: 64 to 65536 in powers of 2.

Measurement Modes SANORMAL, SASGRAM

Examples :SENSe:SPECTrum:FFT:LENGth 1024
sets the number of FFT points to 1024.

Related Commands [:SENSe]:SPECTrum:BWIDth:STATe, [:SENSe]:SPECTrum:FFT:ERESolution

[[:SENSe]:SPECTrum:FFT:START(?)

Sets or queries the start point of the 1024-point FFT frame by the number of samples from the previous frame for the FFT overlap.

NOTE. This command is valid when :INSTRument[:SELEct] is set to SARTIME (Real Time S/A).

Syntax [:SENSe]:SPECTrum:FFT:START <value>

[:SENSe]:SPECTrum:FFT:START?

Arguments <value>::={ 64 | 128 | 256 | 512 | 1024 } selects the start point of the 1024-point FFT frame by the number of samples from the previous frame.

Measurement Modes SARTIME

Examples :SENSe:SPECTrum:FFT:START 256
sets the start point of the 1024-point FFT frame to 256 samples.

[[:SENSe]:SPEctrum:FFT:WINDow[:TYPE](?)

Selects or queries the FFT window function. This command is valid when [:SENSe]:SPEctrum:BANDwidth[:BWIDth:STATe] is OFF.

Syntax [:SENSe]:SPEctrum:FFT:WINDow[:TYPE] { BH3A | BH3B | BH4A | BH4B | BLACKman | HAMMing | HANNing | PARZen | ROSEnfield | WELCh | SLOBe | SCUBed | ST4T | FLATtop | RECT }

[:SENSe]:SPEctrum:FFT:WINDow[:TYPE]?

Arguments Table 2–48 shows the arguments and their meanings.

Table 2–48: FFT windows

Argument	FFT window
BH3A	Blackman–Harris 3A type
BH3B	Blackman–Harris 3B type
BH4A	Blackman–Harris 4A type
BH4B	Blackman–Harris 4B type
BLACKman	Blackman
HAMMing	Hamming
HANNing	Hanning
PARZen	Parzen
ROSEnfield	Rosenfield
WELCh	Welch
SLOBe	Sine lobe
SCUBed	Sine cubed
ST4T	Sine to 4th
FLATtop	Flat top
RECT	Rectangular

Measurement Modes SANORMAL, SASGRAM

Examples :SENSe:SPEctrum:FFT:WINDow:TYPE HAMMing
selects the Hamming window.

Related Commands [:SENSe]:SPEctrum:BANDwidth[:BWIDth:STATe]

[:SENSe] :SPECTrum :FRAMe (?)

Sets or queries the frame number of the spectrum frame to be measured in the Real Time S/A (real-time spectrum analysis) mode.

Syntax [:SENSe] :SPECTrum :FRAMe <number>

[:SENSe] :SPECTrum :FRAMe ?

Arguments <number> : : <NR1> specifies the frame number. Range: -M to 0 (M: Block size set with the [:SENSe] :BSIZe command)

Measurement Modes SARTIME

Examples :SENSe :SPECTrum :FRAMe -5
sets the frame number to -5.

Related Commands [:SENSe] :BSIZe, [:SENSe] :SPECTrum :BLOCk

[[:SENSe]:SPEctrum:MEASurement(?)]

Selects and runs the measurement item in the S/A (spectrum analysis) mode. The query version of this command returns the current measurement item.

Syntax [:SENSe]:SPEctrum:MEASurement { OFF | CHPower | ACPower | OBWidth
| EBWidth | CNRatio | CFrequency | SPURious }

[:SENSe]:SPEctrum:MEASurement?

Arguments Table 2–49 shows the arguments and their meanings.

Table 2–49: S/A mode measurement items

Argument	Measurement item
OFF	Turns off the measurement.
CHPower	Channel power
ACPower	Adjacent channel leakage power (ACPR)
OBWidth	Occupied bandwidth (OBW)
EBWidth	Emission bandwidth (EBW)
CNRatio	Carrier-to-noise ratio (C/N)
CFrequency	Carrier frequency
SPURious	Spurious signal

Measurement Modes SANORMAL, SASGRAM, SARTIME

Examples :SENSe:SPEctrum:MEASurement CHPower
runs the channel power measurement.

[[:SENSe]:SPURious Subgroup

The [[:SENSe]:SPURious commands set up the conditions related to the spurious signal measurement.

Command Tree	Header	Parameter
	[[:SENSe]	
	:SPURious	
	[:THReshold]	
	:EXCursion	<numeric_value>
	:IGNore	<numeric_value>
	:SIGNal	<numeric_value>
	:SPURious	<numeric_value>

Prerequisites for Use To use a command of this group, you must have run at least the following two commands:

1. Run the following command to set the measurement mode to S/A:
`:INSTRument[:SElect] { SANORMAL | SASGRAM | SARTIME }`
2. Run one of the following commands to start the spurious signal measurement:
 - To start the measurement with the default settings:
`:CONFIgure:SPECTrum:SPURious`
 - To start the measurement without modifying the current settings:
`[[:SENSe]:SPECTrum:MEASurement SPURious`

[[:SENSe]:SPURious[:THReshold]:EXCursion(?)]

Sets or queries the excursion level to determine if the signal is spurious in the spurious signal measurement (see Figure 2–24).

Syntax [[:SENSe]:SPURious[:THReshold]:EXCursion <level>

[[:SENSe]:SPURious[:THReshold]:EXCursion?

Arguments <level>::=<NRf> specifies the excursion level. If the signal exceeds the excursion level and meets the other threshold requirements that you set, it is decided to be spurious. Range: 0 to 30 dB (default: 3dB)

Measurement Modes SANORMAL, SASGRAM, SARTIME

Examples :SENSe:SPURious:THReshold:EXCursion 5
sets the excursion level to 5 dB.

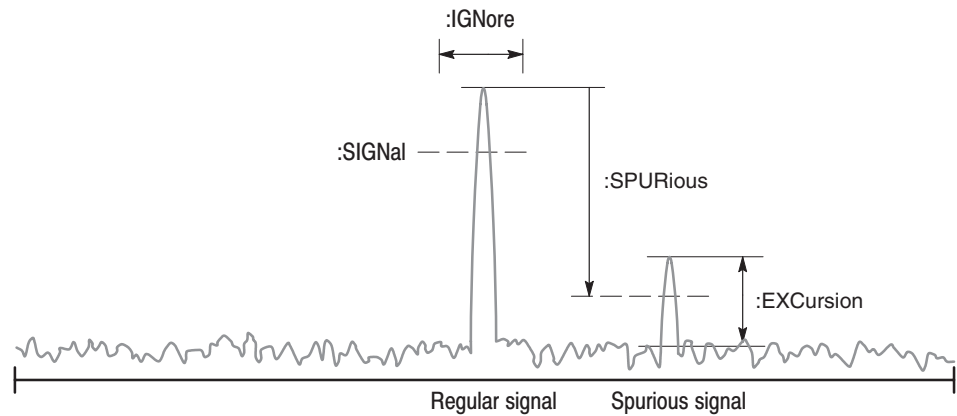

NOTE: Command header [[:SENSe]:SPURious[:THReshold]] is omitted here.

Figure 2–24: Setting up the spurious signal measurement

[[:SENSe]:SPURious[:THReshold]:IGNore(?)

Sets or queries the range not to detect spurious signals around the carrier peak signal to avoid mistaking spurious (see Figure 2–24).

Syntax [:SENSe]:SPURious[:THReshold]:IGNore <value>
 [:SENSe]:SPURious[:THReshold]:IGNore?

Arguments <value>::=<NRf> specifies the range not to detect spurious around the carrier peak signal. Range: 0 to Span/2 [Hz].

Measurement Modes SANORMAL, SASGRAM, SARTIME

Examples :SENSe:SPURious:THReshold:IGNore 1MHz
 sets the range not to detect spurious to 1 MHz.

[[:SENSe]:SPURious[:THReshold]:SIGNa1(?)

Sets or queries the threshold level to determine if the signal is the carrier in the spurious signal measurement (see Figure 2–24).

Syntax [:SENSe]:SPURious[:THReshold]:SIGNa1 <level>
 [:SENSe]:SPURious[:THReshold]:SIGNa1?

Arguments <level>::=<NR1> specifies the signal criterion level. If the signal exceeds the level, it is decided to be the carrier. Range: –100 to +30 dBm

Measurement Modes SANORMAL, SASGRAM, SARTIME

Examples :SENSe:SPURious:THReshold:SIGNa1 -30
 sets the carrier criterion level to –30 dBm.

[[:SENSe]:SPURious[:THReshold]:SPURious(?)]

Sets or queries the threshold level to determine if the signal is spurious in the spurious signal measurement (see Figure 2–24).

Syntax [:SENSe]:SPURious[:THReshold]:SPURious <level>

 [:SENSe]:SPURious[:THReshold]:SPURious?

Arguments <level>::=<NR1> specifies the spurious criterion level relative to the carrier peak. If the signal exceeds the level and meets the other threshold requirements that you set, it is decided to be spurious. Range: –90 to –30 dB.

Measurement Modes SANORMAL, SASGRAM, SARTIME

Examples :SENSe:SPURious:THReshold:SPURious –50
 sets the spurious criterion level to –50 dB relative to the carrier peak.

[[:SENSe]:TRANsient Subgroup

The [[:SENSe]:TRANsient commands set up the conditions related to the time characteristic analysis. The time characteristic analysis includes IQ level vs. time, power vs. time, and frequency vs. time measurements.

NOTE. To use a command of this group, you must have selected *TRAN* (time characteristic analysis) in the *:INSTrument[:SElect]* command.

Command Tree	Header	Parameter
	[[:SENSe]	
	:TRANsient	
	:BLOCK	<numeric_value>
	[:IMMediate]	
	:ITEM	IQVTime PVTime FVTime
	:LENGth	<numeric_value>
	:OFFSet	<numeric_value>

For the commands defining the analysis range, see the figure below. The analysis range is shown by a green line in the overview.

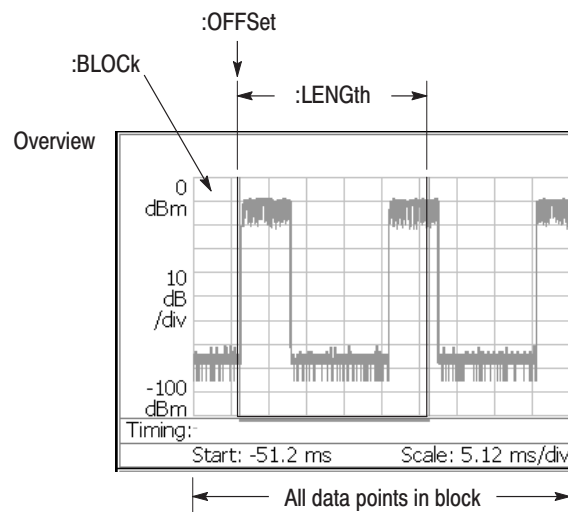

NOTE: Command header [[:SENSe]:TRANsient is omitted here.

Figure 2-25: Defining the analysis range

[:SENSe]:TRANsient:BLOCK(?)

Sets or queries the number of the block to measure in the time characteristic analysis.

Syntax [:SENSe]:TRANsient:BLOCK <value>
 [:SENSe]:TRANsient:BLOCK?

Arguments <value>::=<NR1> specifies the block number. Zero represents the latest block.
 Range: -M to 0 (M: Number of acquired blocks)

Measurement Modes TIMTRAN

Examples :SENSe:TRANsient:BLOCK -5
 sets the block number to -5.

[:SENSe]:TRANsient[:IMMediate] (No Query Form)

Runs the time characteristic analysis calculation for the acquired data.
 To select the measurement item, use the [:SENSe]:TRANsient:ITEM command.
 To acquire data, use the :INITiate command.

Syntax [:SENSe]:TRANsient[:IMMediate]

Arguments None

Measurement Modes TIMTRAN

Examples :SENSe:TRANsient:IMMediate
 runs the time characteristic analysis calculation.

Related Commands :INITiate, [:SENSe]:TRANsient:ITEM

[[:SENSe]:TRANsient:ITEM(?)]

Selects or queries the measurement item in the time characteristic analysis.

Syntax [:SENSe]:TRANsient:ITEM { OFF | IQVTime | PVTTime | FVTTime }
[:SENSe]:TRANsient:ITEM?

Arguments OFF turns off measurement.
IQVTime selects the IQ level vs. time measurement.
PVTTime selects the power vs. time measurement.
FVTTime selects the frequency vs. time measurement.

Measurement Modes TIMTRAN

Examples :SENSe:TRANsient:ITEM IQVTime
selects the IQ level vs. time measurement.

[[:SENSe]:TRANsient:LENGth(?)]

Sets or queries the range for the time characteristic analysis.

Syntax [:SENSe]:TRANsient:LENGth <value>
[:SENSe]:TRANsient:LENGth?

Arguments <value>::=<NR1> specifies the analysis range by the number of data points.
Range: 1 to 1024 × Block size (Block size ≤ 500).
To set the block size, use the [:SENSe]:BSIZE command.

Measurement Modes TIMTRAN

Examples :SENSe:TRANsient:LENGth 1000
sets the analysis range to 1000 points.

Related Commands [:SENSe]:BSIZE

[[:SENSe]:TRANsient:OFFSet(?)

Sets or queries the measurement start position in the time characteristic analysis.

Syntax [:SENSe]:TRANsient:OFFSet <value>
 [:SENSe]:TRANsient:OFFSet?

Arguments <value>::=<NR1> defines the measurement start position by the number of points. Range: 0 to 1024 × (Block size). To set the block size, use the [:SENSe]:BSIZE command.

Measurement Modes TIMTRAN

Examples :SENSe:TRANsient:OFFSet 500
 sets the measurement start position to point 500.

Related Commands [:SENSe]:BSIZE

:STATus Commands

The :STATus commands control the SCPI-defined status reporting structures. In addition to those in IEEE 488.2, the analyzer has questionable and operation registers defined in SCPI. These registers conform to the IEEE 488.2 specification and each is comprised of a condition register, an event register, an enable register, and negative and positive transition filters. For details on these registers, refer to *Status and Events* beginning on page 3–1.

Command Tree

Header	Parameter
:STATus	
:OPERation	
:CONDition	
:ENABle	<bit_value>
[:EVENT]?	
:NTRansition	<bit_value>
:PTRansition	<bit_value>
:PRESet	
:QUESTionable	
:CONDition	
:ENABle	<bit_value>
[:EVENT]?	
:NTRansition	<bit_value>
:PTRansition	<bit_value>

:STATus:OPERation:CONDition? (Query Only)

Returns the contents of the Operation Condition Register (OCR).
For detail on the register, refer to Chapter 3, *Status and Events*.

Syntax :STATus:OPERation:CONDition?

Arguments None

Returns <NR1> is a decimal number showing the contents of the OCR.

Measurement Modes All

Examples :STATus:OPERation:CONDition?
might return 16, showing that the bits in the OCR have the binary value 000000000010000, which means the analyzer is in measurement.

:STATus:OPERation:ENABLE (?)

Sets or queries the enable mask of the Operation Enable Register (OENR) which allows true conditions in the Operation Event Register to be reported in the summary bit. For detail on the register, refer to Chapter 3, *Status and Events*.

Syntax :STATus:OPERation:ENABLE <bit_value>
:STATus:OPERation:ENABLE?

Arguments <bit_value>::=<NR1> is the enable mask of the OENR. Range: 0 to 65535.

Returns <NR1> is a decimal number showing the contents of the OENR.
Range: 0 to 32767 (The most-significant bit cannot be set true.)

Measurement Modes All

Examples :STATus:OPERation:ENABLE 1
enables the CALibrating bit.

:STATus:OPERation:ENABLE?
might return 1, showing that the bits in the OENR have the binary value 00000000 00000001, which means that the CAL bit is valid.

:STATus:OPERation[:EVENT]? (Query Only)

Returns the contents of the Operation Event Register (OEVR). Reading the OEVR clears it. For detail on the register, refer to Chapter 3, *Status and Events*.

Syntax :STATus:OPERation[:EVENT]?

Arguments None

Returns <NR1> is a decimal number showing the contents of the OEVR.

Measurement Modes All

Examples STATus:OPERation:EVENT?
might return 1, showing that the bits in the OEVR have the binary value 00000000 00000001, which means that the CAL bit is set.

:STATus:OPERation:NTRansition (?)

Sets or queries the negative transition filter value of the Operation Transition Register (OTR). For detail on the register, refer to Chapter 3, *Status and Events*.

Syntax :STATus:OPERation:NTRansition <bit_value>
:STATus:OPERation:NTRansition?

Arguments <bit_value>::=<NR1> is the negative transition filter value. Range: 0 to 65535.

Returns <NR1> is a decimal number showing the contents of the OTR.
Range: 0 to 32767 (The most-significant bit cannot be set true.)

Measurement Modes All

Examples :STATus:OPERation:NTRansition #H120
sets the negative transition filter value to #H120.

:STATus:OPERation:NTRansition?
might return 288.

:STATUS:OPERation:PTRansition (?)

Sets or queries the positive transition filter value of the Operation Transition Register (OTR). For detail on the register, refer to Chapter 3, *Status and Events*.

Syntax :STATUS:OPERation:PTRansition <bit_value>

:STATUS:OPERation:PTRansition?

Arguments <bit_value>::=<NR1> is the positive transition filter value. Range: 0 to 65535.

Returns <NR1> is a decimal number showing the contents of the OTR.
Range: 0 to 32767 (The most-significant bit cannot be set true.)

Measurement Modes All

Examples :STATUS:OPERation:PTRansition 0
sets the positive transition filter value to 0.

:STATUS:OPERation:PTRansition?
might return 0.

:STATUS:PRESet (No Query Form)

Presets SCPI enable registers OENR (Operation Enable Register) and QENR (Questionable Enable Register). For details on the registers, refer to Chapter 3, *Status and Events*.

Syntax :STATUS:PRESet

Arguments None

Measurement Modes All

Examples :STATUS:PRESet
presets the registers OENR and QENR.

:STATus:QUESTIONable:CONDition? (Query Only)

Returns the contents of the Questionable Condition Register (QCR).
For detail on the register, refer to Chapter 3, *Status and Events*.

NOTE. *The QCR is not used in the RSA3303A/RSA3308A analyzer.*

Syntax :STATus:QUESTIONable:CONDition?

Arguments None

Returns <NR1> is a decimal number showing the contents of the QCR.

Measurement Modes All

:STATus:QUESTIONable:ENABLE (?)

Sets or queries the enable mask of the Questionable Enable Register (QENR) which allows true conditions in the Questionable Event Register to be reported in the summary bit. For detail on the register, refer to Chapter 3, *Status and Events*.

NOTE. *The QENR is not used in the RSA3303A/RSA3308A analyzer.*

Syntax :STATus:QUESTIONable:ENABLE <bit_value>
:STATus:QUESTIONable:ENABLE?

Arguments <bit_value>::=<NR1> is the enable mask of QENR. Range: 0 to 65535.

Returns <NR1> is a decimal number showing the contents of the QENR.
Range: 0 to 32767 (The most-significant bit cannot be set true.)

Measurement Modes All

:STATus:QUEStionable[:EVENT]? (Query Only)

Returns the contents of the Questionable Event Register (QEVr). Reading the QEVr clears it. For detail on the register, refer to Chapter 3, *Status and Events*.

NOTE. *The QEVr is not used in the RSA3303A/RSA3308A analyzer.*

Syntax :STATus:QUEStionable[:EVENT]?

Arguments None

Returns <NR1> is a decimal number showing the contents of the QEVr.

Measurement Modes All

:STATus:QUEStionable:NTRansition (?)

Sets or queries the negative transition filter value of the Operation Transition Register (QTR). For detail on the register, refer to Chapter 3, *Status and Events*.

NOTE. *The QTR is not used in the RSA3303A/RSA3308A analyzer.*

Syntax :STATus:QUEStionable:NTRansition <bit_value>
 :STATus:QUEStionable:NTRansition?

Arguments <bit_value>::=<NR1> is the negative transition filter value. Range: 0 to 65535.

Returns <NR1> is a decimal number showing the contents of the QTR.
 Range: 0 to 32767 (The most-significant bit cannot be set true.)

Measurement Modes All

:STATus:QUESTionable:PTRansition (?)

Sets or queries the positive transition filter value of the Questionable Transition Register (QTR). For detail on the register, refer to Chapter 3, *Status and Events*.

NOTE. *The QTR is not used in the RSA3303A/RSA3308A analyzer.*

Syntax :STATus:QUESTionable:PTRansition <bit_value>
 :STATus:QUESTionable:PTRansition?

Arguments <bit_value>::=<NR1> is the positive transition filter value. Range: 0 to 65535.

Returns <NR1> is a decimal number showing the contents of the QTR.
 Range: 0 to 32767 (The most-significant bit cannot be set true.)

Measurement Modes All

:SYSTem Commands

The :SYSTem commands set up the system-related conditions.

Command Tree

Header	Parameter
:SYSTem	
:DATE	<year>,<month>,<day>
:ERRor	
:ALL?	
:CODE	
:ALL?	
[:NEXT]?	
:COUNT?	
[:NEXT]?	
:KLOCK	<boolean>
:OPTions?	
:PRESet	
:TIME	<hour>,<minute>,<second>
:VERSion?	

:SYSTem:DATE (?)

Sets or queries the date (year, month, and day). This command is equivalent to the date setting through the Windows Control Panel.

Syntax :SYSTem:DATE <year>,<month>,<day>

 :SYSTem:DATE?

Arguments <year>::=<NRf> specifies the year (4 digits). Range: 2000 to 2099

 <month>::=<NRf> specifies the month. Range: 1 (January) to 12 (December)

 <day>::=<NRf> specifies the day. Range: 1 to 31

 These values are rounded to the nearest integer.

 *RST has no effect on the settings.

Measurement Modes All

Examples :SYSTem:DATE 2002,3,19
 sets the internal calendar to March 19, 2002.

Related Commands :SYSTem:TIME

:SYSTem:ERRor:ALL? (Query Only)

Returns all the unread information from the error/event queue, and removes all the information from the queue. For details of the error messages, refer to page 3–17.

Syntax :SYSTem:ERRor:ALL?

Arguments None

Returns <ecode>,"<edesc>[;<einfo>]"{"<ecode>,"<edesc>[;<einfo>]"}

Where

<ecode>::=<NR1> is the error/event code (–32768 to 32767).

<edesc>::=<string> is the description on the error/event.

<einfo>::=<string> is the detail of the error/event.

Measurement Modes All

Examples :SYSTem:ERRor:ALL?
might return
–130, "Suffix error; Unrecognized suffix, INPut:MLEVel –10dB",
indicating that the unit of the reference level is improper.

:SYSTem:ERRor:CODE:ALL? (Query Only)

Returns all the unread error/event codes from the error/event queue, and removes all the information from the queue. For details of the error messages, refer to page 3–17.

Syntax :SYSTem:ERRor:CODE:ALL?

Arguments None

Returns <ecode>{,<ecode>}

Where

<ecode>::=<NR1> is the error/event code, ranging from –32768 to 32767.

Measurement Modes All

Examples :SYSTem:ERRor:CODE:ALL?
might return –101, –108 of the error codes.

:SYSTem:ERRor:CODE[:NEXT]? (Query Only)

Returns the most recent unread error/event code from the error/event queue, and removes that information from the queue. For details of the error messages, refer to page 3–17.

Syntax :SYSTem:ERRor:CODE[:NEXT]?

Arguments None

Returns <ecode>::=<NR1> is the error/event code, ranging from –32768 to 32767.

Measurement Modes All

Examples :SYSTem:ERRor:CODE:NEXT?
might return –101 of the error code.

:SYSTem:ERRor:COUnT? (Query Only)

Returns the number of unread errors/events placed in the error/event queue.

Syntax :SYSTem:ERRor:COUnT?

Arguments None

Returns <enum>::=<NR1> is the number of errors/events.

Measurement Modes All

Examples :SYSTem:ERRor:COUnT?
might return 2, indicating that the error/event queue contains two of unread errors/events.

:SYSTem:ERRor[:NEXT]? (Query Only)

Returns the next item from the error/event queue, and removes that item from the queue. For details of the error messages, refer to page 3–17.

Syntax :SYSTem:ERRor[:NEXT]?

Arguments None

Returns <ecode>,"<edesc>[;<einfo>]"

Where

<ecode>::=<NR1> is the error/event code, ranging from –32768 to 32767.

<edesc>::=<string> is the description on the error/event.

<einfo>::=<string> is the detail of the error/event.

Measurement Modes All

Examples :SYSTem:ERRor:NEXt?
might return
–130, "Suffix error; Unrecognized suffix, INPut:MLEVel –10dB",
indicating that the unit is improper.

:SYSTem:KLOCK (?)

Determines whether to lock or unlock the front panel key controls.

Syntax :SYSTem:KLOCK { OFF | ON | 0 | 1 }
 :SYSTem:KLOCK?

Arguments OFF or 0 unlocks the front panel key controls.
 ON or 1 locks the front panel key controls.

Measurement Modes All

Examples :SYSTem:KLOCK ON
 locks the front panel key controls.

:SYSTem:OPTions? (Query Only)

Queries the options installed in the analyzer.
This command is equivalent to the IEEE common command *OPT?.

Syntax :SYSTem:OPTions?

Arguments None

Returns <option>::=<string> contains the comma-separated option numbers.

Measurement Modes All

Examples :SYSTem:OPTions?
 might return "02,03,21", indicating that Option 02, 03, and 21 are currently
 installed in the analyzer.

Related Commands :INSTRument[:SElect]

:SYSTem:PRESet (No Query Form)

Restores the analyzer to the defaults.
This command is equivalent to the PRESET key on the front panel.

Syntax :SYSTem:PRESet

Arguments None

Measurement Modes All

Examples :SYSTem:PRESet
restores the analyzer to the defaults.

:SYSTem:TIME (?)

Sets or queries the time (hours, minutes, and seconds). This command is equivalent to the time setting through the Windows Control Panel.

Syntax :SYSTem:TIME <hour>,<minute>,<second>
:SYSTem:TIME?

Arguments <hour>::=<NRf> specifies the hours. Range: 0 to 23.
<minute>::=<NRf> specifies the minutes. Range: 0 to 59.
<second>::=<NRf> specifies the seconds. Range: 0 to 59.
These values are rounded to the nearest integer.
*RST has no effect on the settings.

Measurement Modes All

Examples :SYSTem:TIME 10,15,30
sets the time to 10:15:30.

Related Commands :INSTrument[:SElect]

:SYSTem:VERsion? (Query Only)

Returns the SCPI version number for which the analyzer complies.

Syntax :SYSTem:VERsion?

Arguments None

Returns <NR2> has the form YYYY.V where the Ys represent the year-version (for example, 1999) and the V represents an approved revision number for that year.

Measurement Modes All

Examples :SYSTem:VERsion?
might return 1999.0 for the SCPI version.

:TRACe Commands

The :TRACe commands set up display of Trace 1 and 2.

NOTE. The :TRACe commands are available in the S/A (spectrum analysis) mode except real-time. To use a command in this group, you must have selected SANORMAL or SASGRAM with the :INSTRUMENT [:SElect] command.

Command Tree

Header	Parameter
:TRACe<x> :DATA<x>	
:AVERage	
:CLEar	
:COUNT	<numeric_value>
:DDETEctor	MAXimum MINimum PTPeak
:MODE	NORMal AVERage MAXHold MINHold FREeze OFF

Where

TRACe<x> ::= { TRACe[1] | TRACe2 } or DATA<x> ::= { DATA[1] | DATA2 }

TRACe[1] or DATA[1] indicates that this setup is made for Trace 1.

TRACe2 or DATA2 indicates that this setup is made for Trace 2.

:TRACe<x>|:DATA<x>:AVERAge:CLEAr (No Query Form)

Clears average data and counter, and restarts the average process for the specified trace.

This command is effective when you select AVERAge, MAXHold or MINHold with the :TRACe<x>|:DATA<x>:MODE command.

Syntax :TRACe<x>|:DATA<x>:AVERAge:CLEAr

Arguments None

Measurement Modes SANORMAL, SASGRAM

Examples :TRACe1:AVERAge:CLEAr
clears average data and counter, and restarts the average process for Trace 1.

Related Commands :TRACe<x>|:DATA<x>:MODE

:TRACe<x>|:DATA<x>:AVERAge:COUNT (?)

Sets or queries the number of traces to combine using the :MODE setting (refer to page 2–388).

This command is effective when you select AVERAge, MAXHold or MINHold with the :TRACe<x>|:DATA<x>:MODE command.

Syntax :TRACe<x>|:DATA<x>:AVERAge:COUNT <value>

:TRACe<x>|:DATA<x>:AVERAge:COUNT?

Arguments <value>::=<NR1> specifies the number of traces to combine for averaging.
Range: 1 to 100000 (default: 20)

Measurement Modes SANORMAL, SASGRAM

Examples :TRACe1:AVERAge:COUNT 64
sets the average count to 64 for Trace 1.

Related Commands :TRACe<x>|:DATA<x>:MODE, :TRACe<x>|:DATA<x>:AVERAge:TCONtrol

:TRACe<x>|:DATA<x>:DDETECTOR (?)

Selects or queries the display detector (method to be used for decimating traces to fit the available horizontal space on screen).

The number of horizontal pixels on screen is generally smaller than that of waveform data points. When actually displayed, the waveform data is therefore thinned out, according to the number of pixels, for being compressed. For the details, refer to the *RSA3303A and RSA3308A User Manual*.

Syntax :TRACe<x>|:DATA<x>:DDETECTOR { MAXimum | MINimum | PTPeak }
 :TRACe<x>|:DATA<x>:DDETECTOR?

Arguments MAXimum displays the maximum data value for each pixel.
 MINimum displays the minimum data value for each pixel.
 PTPeak displays the maximum and minimum data value by connecting them with a line for each pixel.

Measurement Modes SANORMAL, SASGRAM

Examples :TRACe1:DDETECTOR MAXimum
 displays the maximum data value for each pixel on Trace 1.

:TRACe<x>|:DATA<x>:MODE (?)

Selects or queries how to display Trace 1 and/or Trace 2.

Syntax :TRACe<x>|:DATA<x>:MODE { NORMa1 | AVERAge | MAXHo1d | MINHo1d | FREeze | OFF }

:TRACe<x>|:DATA<x>:MODE?

Arguments NORMa1 selects an ordinary spectrum display.

AVERAge displays averaged waveform of the specified trace. The number of averages is set with the :TRACe<x>|:DATA<x>:AVERAge:COUNt command.

MAXHo1d holds the maximum level at each frequency.

MINHo1d holds the minimum level at each frequency.

FREeze stops updating the display. But the data acquisition and measurement continues.

OFF displays no trace.

Measurement Modes SANORMAL, SASGRAM

Examples :TRACe1:MODE AVERAge
displays averaged waveform of Trace 1.

Related Commands :TRACe<x>|:DATA<x>:AVERAge:COUNt,
:TRACe<x>|:DATA<x>:AVERAge:TCONtrol

:TRIGger Commands

The :TRIGger commands control triggering.

For details on the trigger, refer to the *RSA3303A and RSA3308A User Manual*.

Command Tree

Header	Parameter
:TRIGger	
[:SEquence]	
:LEVel	
:IF	<numeric_value>
:IQFrequency	<bin_number>,<amplitude> (Option 02 only)
:IQTime	<numeric_value> (Option 02 only)
:MODE	AUTO NORMal
:MPOSITION?	<numeric_value>
:OPOSITION?	<numeric_value>
:POSITION	<numeric_value>
:SLOPe	POSitive NEGative PNEGative NPOSitive
:SOURce	IF EXTernal IQFrequency IQTime

:TRIGger[:SEquence]:LEVel:IF (?)

Sets or queries the trigger level when you select IF with the :TRIGger[:SEquence]:SOURce command.

Syntax :TRIGger[:SEquence]:LEVel:IF <value>
:TRIGger[:SEquence]:LEVel:IF?

Arguments <value>::=<NR1> specifies the IF trigger level. Range: 1 to 100%.

Measurement Modes SARTIME, DEMADEM, DEMDDEM, TIMCCDF, TIMTRAN, TIMPULSE

Examples :TRIGger:SEquence:LEVel:IF 50pct
sets the IF trigger level to 50%.

Related Commands :TRIGger[:SEquence]:SOURce

:TRIGger[:SEquence]:LEVel:IQFRrequency (?)**Option 02 Only**

Sets or queries the trigger level when you select IQFRrequency with the :TRIGger[:SEquence]:SOURce command. The IQ frequency trigger is a triggering function that uses a trigger mask. For details of this function, refer to the *RSA3303A and RSA3308A User Manual*.

Syntax :TRIGger[:SEquence]:LEVel:IQFRrequency <bnm>,<amp1>
:TRIGger[:SEquence]:LEVel:IQFRrequency? <bnm>

Arguments <bnm>::=<NR1> specifies the bin number of the point at which to set the trigger level (a bin is the interval between spectral samples). The valid range depends on the span as shown in Table 2–50.

Table 2–50: Bin number setting range

Span	Bin number
2 MHz or lower	0 to 640
5 MHz, 10 MHz, 20 MHz	0 to 800
15 MHz	0 to 600

<amp1>::=<NRf> specifies the trigger level relative to the reference level at bin #n. Range: -70 to 0 dB.

Measurement Modes SARTIME, DEMADEM, DEMDDEM, TIMCCDF, TIMTRAN, TIMPULSE

Examples The following command sequence sets the trigger mask shown by the gray rectangles in Figure 2–26:

```
:TRIGger:SEquence:LEVel:IQFrequency 0,-10dB
:TRIGger:SEquence:LEVel:IQFrequency 1,-10dB
...
:TRIGger:SEquence:LEVel:IQFrequency 255,-10dB
:TRIGger:SEquence:LEVel:IQFrequency 256,-30dB
:TRIGger:SEquence:LEVel:IQFrequency 257,-30dB
...
:TRIGger:SEquence:LEVel:IQFrequency 384,-30dB
:TRIGger:SEquence:LEVel:IQFrequency 385,-10dB
:TRIGger:SEquence:LEVel:IQFrequency 386,-10dB
...
:TRIGger:SEquence:LEVel:IQFrequency 640,-10dB
```

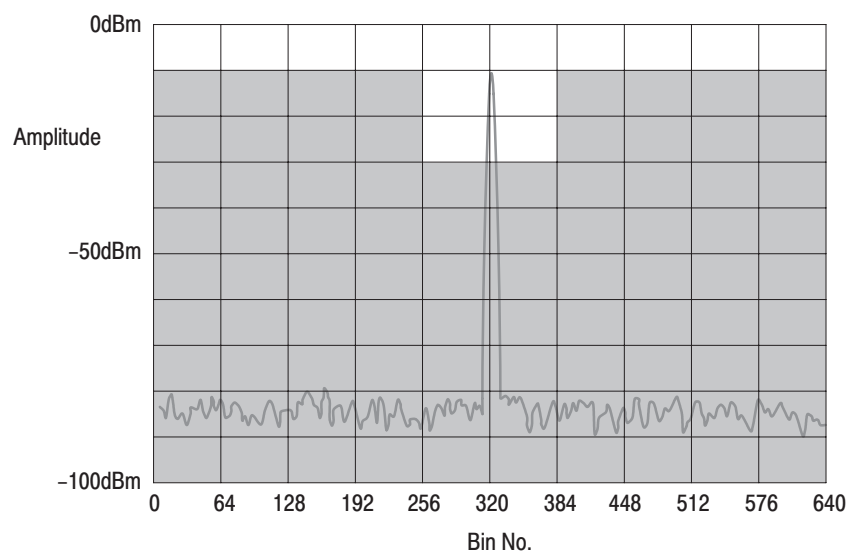

Figure 2–26: Trigger mask setting example

Related Commands :TRIGger[:SEquence]:SOURce

:TRIGger[:SEquence]:LEVel:IQTime (?)

Option 02 Only

Sets or queries the trigger level when you select IQTime with the :TRIGger[:SEquence]:SOURce command.

Syntax :TRIGger[:SEquence]:LEVel:IQTime <amp1>
 :TRIGger[:SEquence]:LEVel:IQTime?

Arguments <amp1>::=<NR1> specifies the IQ time trigger level. Range: -40 to 0 dB.

Measurement Modes SARTIME, DEMADEM, DEMDDEM, TIMCCDF, TIMTRAN, TIMPULSE

Examples :TRIGger:SEquence:LEVel:IQTime -10
 sets the IQ time trigger level to -10 dB.

Related Commands :TRIGger[:SEquence]:SOURce

:TRIGger[:SEQuence]:MODE (?)

Selects or queries the trigger mode.

Syntax :TRIGger[:SEQuence]:MODE { AUTO | NORMa1 }
:TRIGger[:SEQuence]:MODE?

Arguments AUTO generates a trigger when the :INITiate[:IMMEDIATE] command is sent. In the single mode, data for one waveform is acquired and displayed. In the continuous mode, data acquisition and display are repeated.

NORMa1 specifies that when the :INITiate[:IMMEDIATE] command is sent after trigger conditions have been preset, the trigger occurs before the process stops. You can set the trigger source, slope, level, and position as the trigger conditions.

NOTE. When you select Auto for the trigger mode, you cannot set the trigger source, slope, position, and level.

At *RST, the trigger mode is set to Auto.

Measurement Modes SARTIME, DEMADEM, DEMDDEM, TIMCCDF, TIMTRAN, TIMPULSE

Examples :TRIGger:SEQuence:MODE AUTO
selects the auto trigger.

Related Commands :INITiate:CONTinuous, :INITiate[:IMMEDIATE],
:TRIGger[:SEQuence]:LEVel, :TRIGger[:SEQuence]:POStion,
:TRIGger[:SEQuence]:SLOPe, :TRIGger[:SEQuence]:SOURce

:TRIGger[:SEquence]:MPOStion? (Query Only)

Queries the trigger occurrence point in one block data acquired on the memory when measurement results are obtained with the :FETCh or :READ commands.

Syntax :TRIGger[:SEquence]:MPOStion? <value>

Arguments <value>::=<NR1> specifies the block number. Zero indicates the latest block. Range: -2285 to 0 (standard) or -9142 to 0 (option 02)

Returns <NR1> represents the trigger occurrence point. The returned value depends on whether a trigger occurred or not, as shown in the table below.

Trigger occurrence	Returned value ¹
Trigger occurred	-1024 to (block size) × 1024 -1
No trigger occurred	(block size) × 1024

¹ The block size is set with [:SENSe]:BSIZE.

A minus value indicates that the trigger occurred before the block data acquisition.

If you send :TRIGger[:SEquence]:MPOStion? MINimum | MAXimum when the measurement is not performed, "Execution error" (-200) is returned.

NOTE. When you select PNEGative or NPOSitive with the :TRIGger[:SEquence]:SLOPe command or IQFREquency with the :TRIGger[:SEquence]:SOURce command, the returned value is the same as the :TRIGger[:SEquence]:OPOStion? query because the analyzer cannot determine the trigger occurrence point.

Measurement Modes SARTIME, DEMADeM, DEMDdEM, TIMCCDF, TIMTRAN, TImPULSE

Examples :TRIGger:SEquence:MPOStion? -15
might return 123, indicating that the trigger occurred at the 123th data point in the block #-15.

Related Commands [:SENSe]:BSIZE, :TRIGger[:SEquence]:OPOStion?, :TRIGger[:SEquence]:SLOPe, :TRIGger[:SEquence]:SOURce

:TRIGger[:SEQuence]:OPOStion? (Query Only)

Queries the trigger output point in one block data acquired when measurement results are obtained with the :FETCh or :READ commands (the trigger output point is indicated by “T” in the overview on screen).

Syntax :TRIGger[:SEQuence]:OPOStion? <value>

Arguments <value>::=<NR1> specifies the block number. Zero indicates the latest block. Range: -2285 to 0 (standard) or -9142 to 0 (option 02)

Returns <NR1> represents the trigger output point. The value depends on whether a trigger occurred or not, as shown in the table below.

Trigger occurrence	Returned value ¹
Trigger occurred	-1024 to (block size) × 1024 -1
No trigger occurred	(block size) × 1024

¹ The block size is set with [:SENSe]:BSIZE.

A minus value indicates that the trigger was output before the block data acquisition.

If you send :TRIGger[:SEQuence]:OPOStion? MINimum | MAXimum when the measurement is not performed, “Execution error” (-200) is returned.

Measurement Modes SARTIME, DEMADEM, DEMDDEM, TIMCCDF, TIMTRAN, TIMPULSE

Examples :TRIGger:SEQuence:OPOStion? -15
might return 134, indicating that the trigger output occurs at the 134th data point in the block #-15.

Related Commands [:SENSe]:BSIZE

:TRIGger[:SEQuence]:POSition (?)

Sets or queries a trigger position.

Syntax :TRIGger[:SEQuence]:POSition <value>
 :TRIGger[:SEQuence]:POSition?

Arguments <value>::=<NRf> specifies the trigger position. Range: 0 to 100%. The trigger position is represented in percentage within a block. For example, 50% specifies that the trigger will occur at the middle frame in a block.

Measurement Modes SARTIME, DEMADEM, DEMDDEM, TIMCCDF, TIMTRAN, TIMPULSE

Examples :TRIGger:SEQuence:POSition 10pct
 sets the trigger position to 10%.

:TRIGger[:SEQuence]:SLOPe (?)

Selects or queries the trigger slope.

Syntax :TRIGger[:SEQuence]:SLOPe { POSitive | NEGative | PNEGative
| NPOSitive }

:TRIGger[:SEQuence]:SLOPe?

Arguments POSitive generates a trigger on the rising edge of the trigger signal.

NEGative generates a trigger on the falling edge of the trigger signal.

PNEGative specifies that the data of the first block is acquired by generating the trigger on the rising edge of the trigger signal. The data of the next block is acquired by generating the trigger on the falling edge of the trigger signal. The rising and falling edges are changed alternately each time acquisition of one-block data is completed.

NPOSitive specifies that the data of the first block is acquired by generating the trigger on the falling edge of the trigger signal. The data of the next block is acquired by generating the trigger on the rising edge of the trigger signal. The rising and falling edges are changed alternately each time acquisition of one-block data is completed.

Measurement Modes SARTIME, DEMADEM, DEMDDEM, TIMCCDF, TIMTRAN, TIMPULSE

Examples :TRIGger:SEQuence:SLOPe POSitive
generates a trigger on the rising edge of the trigger signal.

:TRIGger[:SEQuence]:SOURce (?)

Selects or queries the trigger source.

Syntax :TRIGger[:SEQuence]:SOURce { IF | EXTerna1 | IQFrequency
| IQTime }

:TRIGger[:SEQuence]:SOURce?

Arguments IF defines the internal IF (Intermediate Frequency) signal as the trigger source (default).

EXTerna1 defines as the trigger source, the external signal that is input through the TRIG IN connector on the rear panel. The trigger level is fixed internally. Refer to the *RSA3303A and RSA3308A User Manual* for the external trigger level specification.

IQFrequency generates a trigger in the frequency domain, using the trigger mask as the trigger source (Option 02 only).

IQTime generates a trigger in the time domain, using the input signal as the trigger source (Option 02 only).

Measurement Modes SARTIME, DEMADEM, DEMDDEM, TIMCCDF, TIMTRAN, TIMPULSE

Examples :TRIGger:SEQuence:SOURce IF
selects the IF trigger.

Related Commands :TRIGger[:SEQuence]:MODE

:UNIT Commands

The :UNIT commands specify fundamental units for measurement.

Command Tree

Header	Parameter
:UNIT	
:ANGLE	DEG RAD

:UNIT:ANGLE (?)

Specifies or queries the fundamental unit of angle.

Syntax :UNIT:ANGLE { DEG | RAD }
 :UNIT:ANGLE?

Arguments DEG selects degree as the unit of angle.
 RAD selects radian as the unit of angle.

Measurement Modes All

Examples :UNIT:ANGLE RAD
 selects radian as the unit of angle.

Retrieving Response Message

When receiving a query command from the external controller, the analyzer puts the response message on the Output Queue. This message cannot be retrieved unless you perform retrieval operations through the external controller. (For example, call the IBRD subroutine included in the GPIB software of National Instruments.)

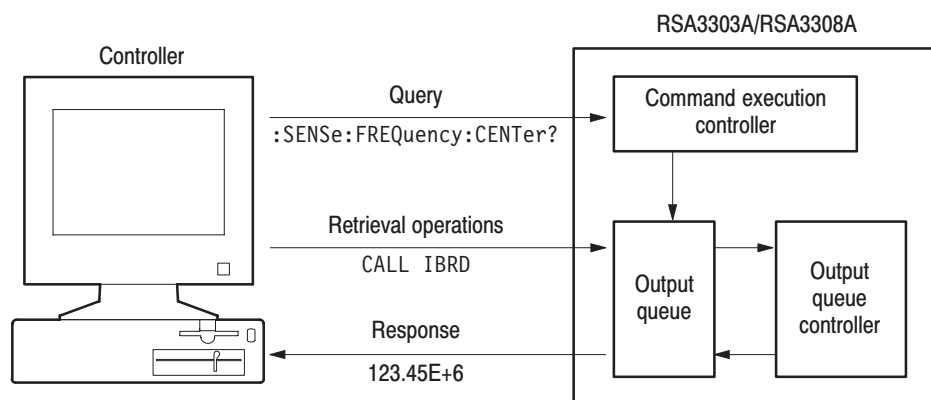

Figure 2-27: Retrieving response message

When the Output Queue contains a response message, sending another command from the external controller before retrieving this message deletes it from the queue. The Output Queue always contains the response message to the most recent query command.

You can use the MAV bit of the Status Byte Register (SBR) to check whether the Output Queue contains a response message. For details, refer to *Status Byte Register (SBR)* on page 3-6.

Status and Events

Status and Events

The SCPI interface in the analyzer includes a status and event reporting system that enables the user to monitor crucial events that occur in the instrument. The analyzer is equipped with four registers and one queue that conform to IEEE Std 488.2-1987. This section will discuss these registers and queues along with status and event processing.

Status and Event Reporting System

Figure 3–1 outlines the status and event reporting mechanism offered in the RSA3300 Series analyzers.

The status and event reporting mechanism contains three major blocks:

- Standard Event Status
- Operation Status
- Questionable Status

The processes performed in these blocks are summarized in the status bytes. They provide the error and event information.

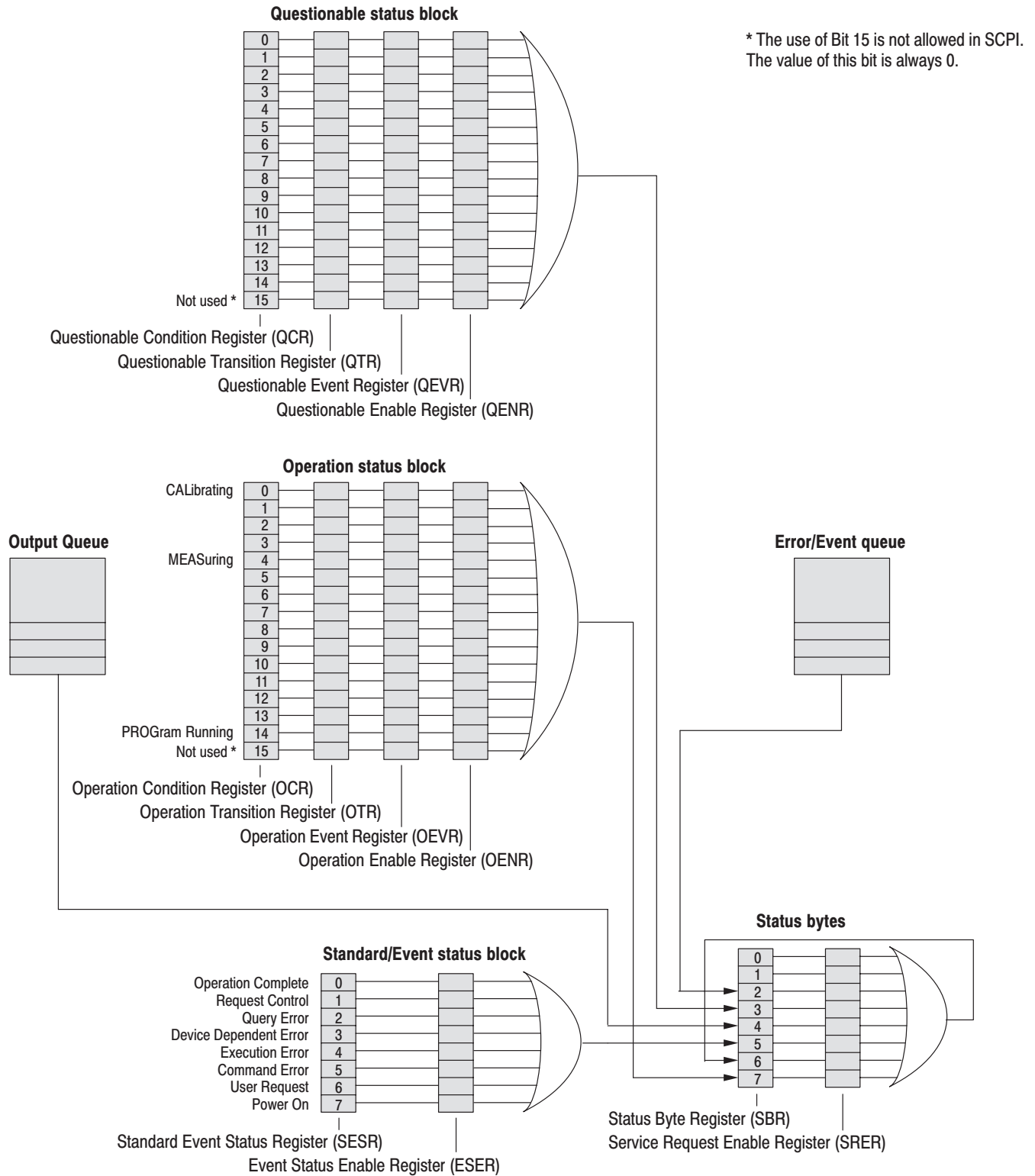

Figure 3-1: Status/Event reporting mechanism

Standard Event Status Block

Reports the power on/off state, command errors, and the running state.

See the Standard/Event Status Block section at the bottom of Figure 3–1. This block contains two registers:

- **Standard Event Status Register (SESR)**
Consists of eight bits. When an error or another event occurs in the analyzer, the corresponding bit of this register is set. The user cannot write any data in this register.
- **Event Status Enable Register (ESER)**
Consists of eight bits, and masks the SESR. The mask is user-definable. By obtaining the logical product with SESR, this register can determine whether to set the Event Status Bit (ESB) of the Status Byte Register (SBR).

Processing Flow. When an event occurs, the SESR bit corresponding to the event is set, resulting in the event being stacked in the Error/Event Queue. The SBR OAV bit is also set. If the bit corresponding to the event has also been set in the ESER, the SBR ESB bit is also set.

When a message is sent to the Output Queue, the SBR MAV bit is set.

Operation Status Block

Reports the active state of the function.

See the Operation Status Block section at the middle of Figure 3–1. This block contains four registers:

- **Operation Condition Register (OCR)**
When the analyzer enters a certain state, the corresponding bit is set. The user cannot write any data in this register.
- **Operation Transition Register (OTR)**
There are two OTR types:
 - **Operation Positive Transition Register (OPTR)**
Filters when the bit corresponding to the OCR changes from False (reset) to True (set).
 - **Operation Negative Transition Register (ONTR)**
Filters when the bit corresponding to the OCR changes from True to False.
- **Operation Event Register (OEVR)**
In the OEVR, the corresponding bit is set through the OTR filter.
- **Operation Enable Register (OENR)**
Masks the OEVR. The mask is user-definable. By obtaining the logical product with SBR, this register can determine whether to set the Operation Status Bit (OSB) of the Status Byte Register (SBR).

For the contents of the bits of this register, refer to *Registers* on page 3–5.

Processing Flow. When the specified state changes in the OCR, its bit is set or reset. This change is filtered with a transition register, and the corresponding bit of the OEVR is set. If the bit corresponding to the event has also been set in the OENR, the SBR OSS bit is also set.

Questionable Status Block

Reports the states related to signals and data, for example, the signal generated by the analyzer or the precision of the data to be acquired. The register organization and the processing flow are the same as the Operation Status Block, except that the corresponding bit of the SBR is the QSB.

NOTE. *The Questionable Status Block is not used in the RSA3303A/RSA3308A analyzer. Any of the values of the registers in this block are always 0.*

Registers

There are three main types of registers:

- **Status Registers:** stores data relating to instrument status. This register is set by the analyzer.
- **Enable Registers:** determines whether to set events that occur in the analyzer to the appropriate bit in the status registers and event queues. This type of register can be set by the user.
- **Transition Registers:** operates as a filter that examines whether an event has occurred or disappeared. This type of register can be set by the user.

Status Registers

There are six status register types:

- **Status Byte Register (SBR)**
- **Standard Event Status Register (SESR)**
- **Operation Condition Register (OCR)**
- **Operation Event Register (OEVR)**
- **Questionable Condition Register (QCR)**
- **Questionable Event Register (QEVR)**

If you need to examine the error or the state of the analyzer, read the contents of these registers.

Status Byte Register (SBR)

The SBR is made up of 8 bits. Bits 4, 5 and 6 are defined in accordance with IEEE Std 488.2-1987 (see Figure 3–2 and Table 3–1). These bits are used to monitor the output queue, SESR and service requests, respectively. The contents of this register are returned when the *STB? query is used.

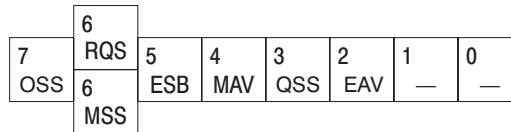

Figure 3–2: The Status Byte Register (SBR)

Table 3–1: SBR bit functions

Bit	Function
7	Operation Summary Status (OSS). Summary of the operation status register.
6	Request Service (RQS)/Master Status Summary (MSS). When the instrument is accessed using the GPIB serial poll command, this bit is called the Request Service (RQS) bit and indicates to the controller that a service request has occurred (in other words, that the GPIB bus SRQ line is LOW). The RQS bit is cleared when serial poll ends. When the instrument is accessed using the *STB? query, this bit is called the Master Status Summary (MSS) bit and indicates that the instrument has issued a service request for one or more reasons. The MSS bit is never cleared to 0 by the *STB? query.
5	Event Status Bit (ESB). This bit indicates whether or not a new event has occurred after the previous Standard Event Status Register (SESR) has been cleared or after an event readout has been performed.
4	Message Available Bit (MAV). This bit indicates that a message has been placed in the output queue and can be retrieved.
3	Questionable Summary Status (QSS). Summary of the Questionable Status Byte register. It is always zero in the RSA3303A/RSA3308A analyzer.
2	Event Quantity Available (EAV). Summary of the Error Event Queue.
1–0	Not used

Standard Event Status Register (SESR)

The SESR is made up of 8 bits. Each bit records the occurrence of a different type of event, as shown in Figure 3–3 and Table 3–2. The contents of this register are returned when the *ESR? query is used.

7	6	5	4	3	2	1	0
PON	—	CME	EXE	DDE	QYE	—	OPC

Figure 3–3: The Standard Event Status Register (SESR)

Table 3–2: SESR bit functions

Bit	Function
7	Power On (PON). Indicates that the power to the instrument is on.
6	Not used.
5	Command Error (CME). Indicates that a command error has occurred while parsing by the command parser was in progress.
4	Execution Error (EXE). Indicates that an error occurred during the execution of a command. Execution errors occur for one of the following reasons: <ul style="list-style-type: none"> ■ When a value designated in the argument is outside the allowable range of the instrument, or is in conflict with the capabilities of the instrument ■ When the command could not be executed properly because the conditions for execution differed from those essentially required
3	Device-Dependent Error (DDE). An instrument error has been detected.
2	Query Error (QYE). Indicates that a query error has been detected by the output queue controller. Query errors occur for one of the following reasons: <ul style="list-style-type: none"> ■ An attempt was made to retrieve messages from the output queue, despite the fact that the output queue is empty or in pending status. ■ The output queue messages have been cleared despite the fact that they have not been retrieved.
1	Not used.
0	Operation Complete (OPC). This bit is set with the results of the execution of the *OPC command. It indicates that all pending operations have been completed.

Operation Condition Register (OCR)

The OCR is made up of 16 bits, which record the occurrence of three types of events, shown in Figure 3–4 and Table 3–3.

15	14 PROG	13	12	11	10	9	8	7	6	5	4 MEAS	3	2	1	0 CAL
----	------------	----	----	----	----	---	---	---	---	---	-----------	---	---	---	----------

Figure 3–4: The Operation Condition Register (OCR)

Table 3–3: OCR bit functions

Bit	Function
15	Not used.
14	Program Running Bit (PROG): Indicates whether the macro program is in execution. Set while the macro program is run by a :PROGRAM:EXECute command. Reset when it ends.
13–5	Not used.
4	Measuring Bit (MEAS): Indicates whether the analyzer is in measurement. When the measurement ends after this bit is set in measurement, it is reset. “In measurement” means that one of the following commands is in execution: :INITiate commands :READ commands [:SENSe]:ADEMod[:IMMediate] [:SENSe]:DDEMod[:IMMediate] [:SENSe]:TRANsient[:IMMediate]
3–1	Not used.
0	Calibration Bit (CAL): Indicates whether the analyzer is in measurement. When the measurement ends after this bit is set in calibration, it is reset.

Operation Event Register (OEVR)

In this instrument, this register has the same content as the Operation Condition Register (OCR), described above.

Questionable Condition Register (QCR)

The QCR is not used in the RSA3303A/RSA3308A analyzer.

Questionable Event Register (QEVR)

The QEVR is not used in the RSA3303A/RSA3308A analyzer.

Enable Registers

There are four enable register types:

- Event Status Enable Register (ESER)
- Service Request Enable Register (SRER)
- Operation Enable Register (OENR)
- Questionable Enable Register (QENR)

Each bit in these enable registers corresponds to a bit in the controlling status register. By setting and resetting the bits in the enable register, the user can determine whether or not events that occur will be registered to the status register and queue.

Event Status Enable Register (ESER)

The ESER is made up of bits defined exactly the same as bits 0 through 7 in the SESR (see Figure 3–5). This register is used by the user to designate whether the SBR ESB bit should be set when an event has occurred and whether the corresponding SESR bit has been set.

To set the SBR ESB bit (when the SESR bit has been set), set the ESER bit corresponding to that event. To prevent the ESB bit from being set, reset the ESER bit corresponding to that event.

Use the *ESE command to set the bits of the ESER. Use the *ESE? query to read the contents of the ESER.

7	6	5	4	3	2	1	0
PON	—	CME	EXE	DDE	QYE	—	OPC

Figure 3–5: The Event Status Enable Register (ESER)

Service Request Enable Register (SRER)

The SRER is made up of bits defined exactly the same as bits 0 through 7 in the SBR (see Figure 3–6). This register is used by the user to determine what events will generate service requests.

The SRER bit 6 cannot be set. Also, the RQS is not maskable.

The generation of a service request with the GPIB interface involves changing the SRQ line to LOW and making a service request to the controller. The result is that a status byte for which an RQS has been set is returned in response to serial polling by the controller.

Use the *SRE command to set the bits of the SRER. Use the *SRE? query to read the contents of the SRER. Bit 6 must normally be set to 0.

7	6	5	4	3	2	1	0
OSB	—	ESB	MAV	QSB	—	—	—

Figure 3–6: The Service Request Enable Register (SRER)

Operation Enable Register (OENR)

Consists of the bits that are defined as the same contents as bits 0 to 15 of the OEVR. This register is used to specify whether to set the SBR OSB bit when occurrence of an event sets the corresponding OEVR bit.

15	14	13	12	11	10	9	8	7	6	5	4	3	2	1	0
	PROG										MEAS				CAL

Figure 3–7: Operation Enable Register (OENR)

To set the contents of the OENR, use a :STATus:OPERation:ENABLE command. To query its contents, use query command STATus:OPERation:ENABLE?.

Questionable Enable Register (QENR)

The QENR is not used in the RSA3303A/RSA3308A analyzer.

Transition Registers

There are two transition register types:

- Operation Transition Register (OTR)
- Questionable Transition Register (QTR)

Operation Transition Register (OTR)

Consists of the bits that are defined as the same contents as bits 0 to 15 of the OCR (refer to page 3–9). This bit has two functions. One is positive transition filtering, which filters when the corresponding bit of the OCR changes from False (reset) to True (set). The other is negative transition filtering, which filters when this bit changes from True to False.

To set the OTR bit to use the register as the positive transition filter, use a `:STATus:OPERation:PTRansition` command. To read the contents from it, use query `:STATus:OPERation:PTRansition?`.

To set the OTR bit to use the register as the negative transition filter, use a `:STATus:OPERation:NTRansition` command. To read the contents from it, use query `:STATus:OPERation:NTRansition?`.

15	14 PROG	13	12	11	10	9	8	7	6	5	4 MEAS	3	2	1	0 CAL
----	------------	----	----	----	----	---	---	---	---	---	-----------	---	---	---	----------

Figure 3–8: Operation Transition Register (OTR)

Questionable Transition Register (QTR)

The QTR is not used in the RSA3303A/RSA3308A analyzer.

Queues

There are two types of queues in the status reporting system used in the analyzer: output queues and event queues.

Output Queue

The output queue is a FIFO queue and holds response messages to queries, where they await retrieval. When there are messages in the queue, the SBR MAV bit is set.

The output queue will be emptied each time a command or query is received, so the controller must read the output queue before the next command or query is issued. If this is not done, an error will occur and the output queue will be emptied; however, the operation will proceed even if an error occurs.

Event Queue

The event queue is a FIFO queue and stores events as they occur in the analyzer. If more than 32 events occur, event 32 will be replaced with event code -350 (“Queue Overflow”). The error code and text are retrieved using the :SYSTem:ERRor queries.

Status and Event Processing Sequence

Figure 3–9 shows an outline of the sequence for status and event processing.

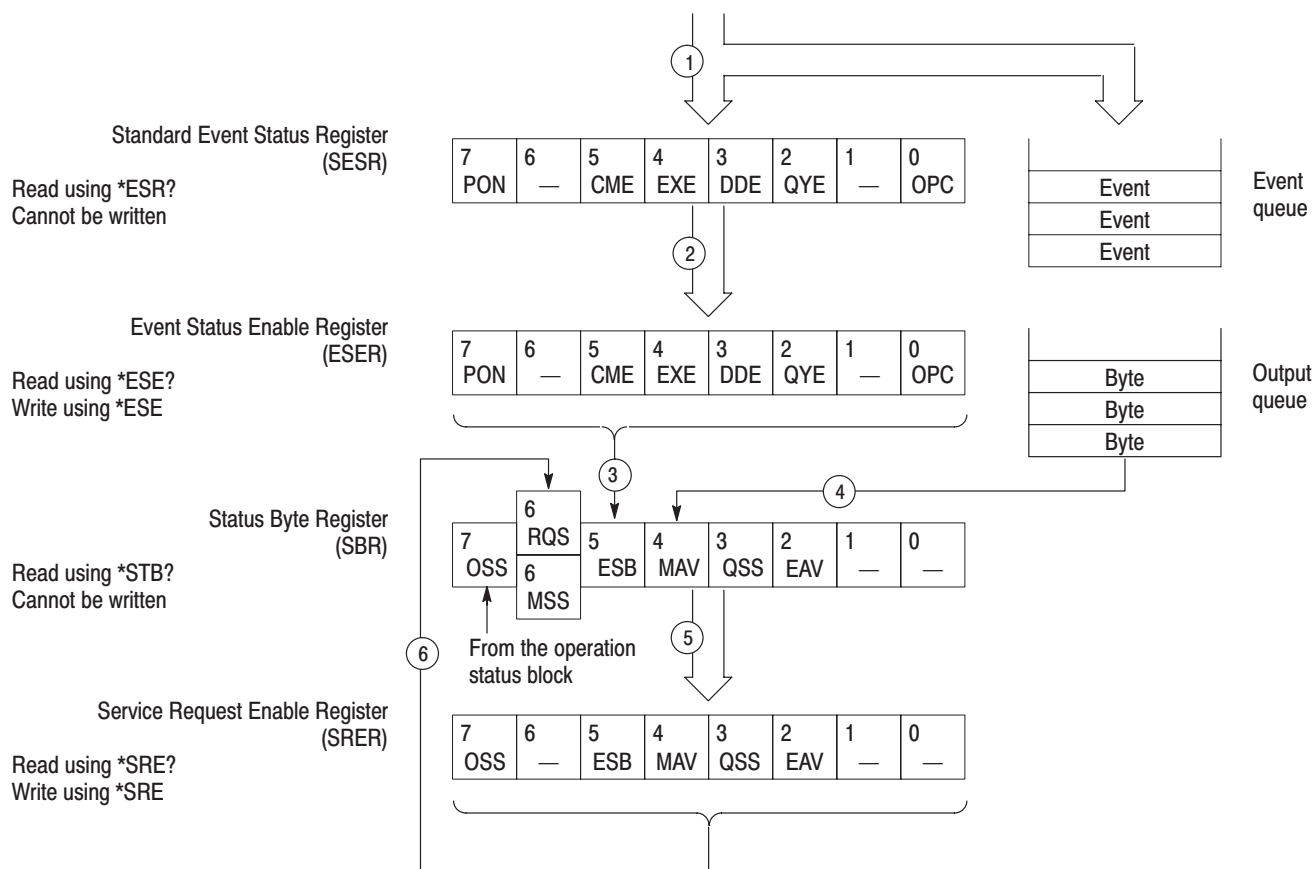

Figure 3–9: Status and event processing sequence

1. If an event has occurred, the SESR bit corresponding to that event is set and the event is placed in the event queue.
2. A bit corresponding to that event in the ESER has is set.
3. The SBR ESB bit is set to reflect the status of the ESER.
4. When a message is sent to the output queue, the SBR MAV bit is set.
5. Setting either the ESB or MAV bits in the SBR sets the respective bit in the SRER.
6. When the SRER bit is set, the SBR MSS bit is set and a service request is generated when using the GPIB interface.

Synchronizing Execution

Almost all commands are executed in the order in which they are sent from the controller, and the execution of each command is completed in a short period of time. However, the following commands perform data analysis in another thread, and another command can thus be executed concurrently:

```
:INITiate commands
:PROGram[:SElected]:EXEcute
:PROGram[:SElected]:NAME
:READ commands
[:SENSe]:ADEMod[:IMMediate]
[:SENSe]:DDEMod[:IMMediate]
[:SENSe]:TRANsient[:IMMediate]
```

These commands are designed so that the next command to be sent is executed without waiting for the previous command to be completed. In some cases, a process executed by another command must first be completed before these commands can be executed; in other cases, these commands must be completed before the next command is executed.

You have two options to achieve command synchronization:

- Using the status and event reporting function
- Using synchronizing commands

Using the Status and Event Reporting Function

In the following example, a :READ command is used to obtain the measurement results while the Operation Condition Register (OCR) is being used to provide synchronization.

```
:STATus:OPERation:NTRansition 16
// Set the filter of the OCR MEASuring bit
:STATus:OPERation:ENABle 16
// Enable the filter of the OCR MEASuring bit
*SRE 128 // Set the SRER OSS bit
:READ:SPECTrum? // Obtain the measurement results
```

The command waits for generation of SRQ.

Using Synchronizing Commands

The IEEE-488.2 common commands include the following synchronizing commands:

```
*OPC
*OPC?
*WAI
```

Using the *OPC Command. The *OPC command sets the SESR OPC bit when all the operations for which it is waiting are completed. If the GPIB interface is in use, you can synchronize the execution by using this command together with the serial polling or service request function.

The following is a command sequence example:

```
*ESE 1      // Enable the ESER OPC bit
*SRE 32     // Enable the SRER ESB bit
:ABORT;INITiate:IMMediate;*OPC
           // Wait for SRQ to provide synchronization
```

Using the Query *OPC? The query *OPC? writes ASCII code “1” into the Output Queue when all operations for which it is waiting are completed. You can provide synchronization using the command string as the following example:

```
:ABORT;INITiate:IMMediate;*OPC?
```

The command waits until “1” is written into the Output Queue. When the command goes to the Output Queue to read the data, a time-out may occur before the data is written into the queue.

Using the *WAI Command. After the process of the preceding command is completed, the *WAI command begins to execute the process of the next command as the following example:

```
:ABORT;INITiate:IMMediate;*WAI
           // Wait for the *WAI process to provide synchronization
```

Error Messages and Codes

Tables 3–4 through 3–7 show the SCPI standard error codes and messages used in the status and event reporting system in the analyzer.

Event codes and messages can be obtained by using the queries :SYSTem:ERRor. These are returned in the following format:

<event code>,"<event message>"

Command Errors

Command errors are returned when there is a syntax error in the command.

Table 3-4: Command errors

Error code	Error message
-100	command error
-101	invalid character
-102	syntax error
-103	invalid separator
-104	data type error
-105	GET not allowed
-108	parameter not allowed
-109	missing parameter
-110	command header error
-111	header separator error
-112	program mnemonic too long
-113	undefined header
-114	header suffix out of range
-120	numeric data error
-121	character
-123	exponent too large
-124	too many digits
-128	numeric data not allowed
-130	suffix error
-131	invalid suffix
-134	suffix too long
-138	suffix not allowed
-140	character data error
-141	invalid character data
-144	character data too long
-148	character data not allowed
-150	string data error
-151	invalid string data
-158	string data not allowed

Table 3-4: Command errors (Cont.)

Error code	Error message
-160	block data error
-161	invalid block data
-168	block data not allowed
-170	command expression error
-171	invalid expression
-178	expression data not allowed
-180	macro error
-181	invalid outside macro definition
-183	invalid inside macro definition
-184	macro parameter error

Execution Errors

These error codes are returned when an error is detected while a command is being executed.

Table 3-5: Execution errors

Error code	Error message
-200	execution error
-201	invalid while in local
-202	settings lost due to RTL
-210	trigger error
-211	trigger ignored
-212	arm ignored
-213	init ignored
-214	trigger deadlock
-215	arm deadlock
-220	parameter error
-221	settings conflict
-222	data out of range
-223	too much data
-224	illegal parameter value
-225	out of memory
-226	lists not same length
-230	data corrupt or stale
-231	data questionable
-240	hardware error
-241	hardware missing
-250	mass storage error
-251	missing mass storage
-252	missing media
-253	corrupt media
-254	media full
-255	directory full
-256	FileName not found
-257	FileName error
-258	media protected

Table 3-5: Execution errors (Cont.)

Error code	Error message
-260	execution expression error
-261	math error in expression
-270	execution macro error
-271	macro syntax error
-272	macro execution error
-273	illegal macro label
-274	execution macro parameter error
-275	macro definition too long
-276	macro recursion error
-277	macro redefinition not allowed
-278	macro header not found
-280	program error
-281	cannot create program
-282	illegal program name
-283	illegal variable name
-284	program currently running
-285	program syntax error
-286	program runtime error

Device Specific Errors

These error codes are returned when an internal instrument error is detected. This type of error may indicate a hardware problem.

Table 3-6: Device specific errors

Error code	Error message
-300	device specific error
-310	system error
-311	memory error
-312	PUD memory lost
-313	calibration memory lost
-314	save/recall memory lost
-315	configuration memory lost
-330	self test failed
-350	queue overflow

Query Errors

These error codes are returned in response to an unanswered query.

Table 3-7: Query errors

Error code	Error message
-400	query error
-410	query interrupted
-420	query unterminated
-430	query deadlocked
-440	query unterminated after indefinite period

Programming Examples

Programming Examples

This section shows an application program sample that controls the analyzer through the GPIB and a macro program execution sample that uses :PROG commands.

- Application program sample
- Macro program execution sample

Application Program Sample

This section shows an application program sample that performs two measurements:

- **Channel power measurement (measCHPOWER() subroutine)**

In the S/A (spectrum analysis) mode, the *OPC command is used to provide synchronization while channel power measurement is being performed. Then, the measured data is saved in a file.

- **FM signal measurement (measFM() subroutine)**

In the Demod (modulation analysis) mode, the status byte MAV bit is used to provide synchronization while the FM vector signal measurement is being performed. Then, the measured data is saved in a file.

This program has been scripted for use in Microsoft Visual C++ 6.0. It operates with an IBM PC-compatible system equipped with National Instruments GPIB board and driver software (operation capabilities confirmed with Windows 98 and National Instruments GPIB board PCI-GPIB). To enable this program, the analyzer must have been set to DEV1 by using wibconf or other means.

```
//  
// Sample program  
//  
// Channel power measurement & FM signal measurement  
//  
#include <windows.h>  
#include <stdio.h>  
#include <string.h>  
  
#include "decl-32.h"  
  
#define LONG_TIME T100s  
#define NORMAL_TIME T10s  
  
#define BOARD_NAME "GPIB0"  
#define MAX_BUF (1024)  
  
// Bit definition of SBR (Status Byte Register)  
#define ESB (1<<5) // ESB (Event Status Bit)  
#define MAV (1<<4) // MAV (Message Available)  
#define EAV (1<<2) // EAV (Event Queue Available)
```



```
char readBuf[MAX_BUF + 1];
char openDevice [MAX_BUF/2 + 1];

void GpibClose(void);
void GpibError(char *errorMessage);
void GpibExit(int code);
void GpibOpen(char *device);
void GpibRead(char *resp, int count);
void GpibReadFile(char *filename);
int GpibSerialPoll(void);
void GpibTimeOut(int timeout);
void GpibWait(int wait);
void GpibWrite(char *string);
void measCHPOWER(void);
void measFM(void);
void WaitOPC(void);
void WaitMAV(void);

int GpibDevice;           // Device descriptor
int GpibBoard;           // GPIB board descriptor
int GpibCount;           // Store ibcnt
int GpibStatus;          // Store ibsta

// Main routine
void
main(int argc, char *argv[])
{
    strcpy(openDevice, "dev1");

    GpibOpen(openDevice); // Detect the specified device

    measCHPOWER();        // Channel power measurement

    measFM();             // FM signal measurement

    GpibClose();          // Terminate the device and board
}
```

```

// Channel power measurement
void
measCHPOWER(void)
{
    GpibWrite("*CLS");    // Clear the status register
    GpibWrite("*ESE 1");  // Set the OPC bit of ESER
    GpibWrite("*SRE 32"); // Set the ESB bit of SRER

    // Set up the analyzer
    GpibTimeout(LONG_TIME);
    GpibWrite("INSTRUMENT 'SANORMAL'");
    GpibWrite("*RST");    // Reset the analyzer
    GpibTimeout(NORMAL_TIME);
    GpibWrite("CONFIGURE:SPECTRUM:CHPower");
    GpibWrite("FREQUENCY:CENTER 1GHz");
    GpibWrite("FREQUENCY:SPAN 1MHz");
    GpibTimeout(LONG_TIME);
    GpibWrite("*CAL?");
    GpibRead(readBuf, MAX_BUF);
    printf("*CAL? result = %s\n", readBuf);
    GpibTimeout(NORMAL_TIME);
    GpibWrite("CHPower:BANDWIDTH:INTEGRATION 300kHz");
    GpibWrite("SPECTRUM:AVERAGE ON");
    GpibWrite("SPECTRUM:AVERAGE:COUNT 100");

    // Perform the measurement
    GpibTimeout(LONG_TIME);
    GpibWrite("INITIATE:CONTINUOUS OFF;*OPC");
    WaitOPC();           // Wait for the OPC bit set
    GpibWrite("INITIATE;*OPC");
    WaitOPC();
    GpibTimeout(NORMAL_TIME);

    // Get measurement results and save them to the file chpower
    GpibWrite("FETCH:SPECTRUM:CHPower?");
    GpibReadFile("chpower");
}

```

```
// FM signal measurement
void
measFM(void)
{
    // Set up the analyzer
    GpibTimeout(LONG_TIME);
    GpibWrite("INSTRUMENT 'DEMADEM'");
    GpibWrite("*RST"); // Reset the analyzer
    GpibTimeout(NORMAL_TIME);
    GpibWrite("CONFIGURE:ADEMod:FM");
    GpibWrite("FREQUENCY:CENTer 1GHz");
    GpibWrite("FREQUENCY:SPAN 1MHz");
    GpibWrite("BSIZE 100");
    GpibTimeout(LONG_TIME);
    GpibWrite("*CAL?");
    GpibRead(readBuf, MAX_BUF);
    printf("*CAL? result = %s\n", readBuf);
    GpibTimeout(NORMAL_TIME);
    GpibWrite("ADEMod:LENGTH 102400");

    GpibWrite("*CLS"); // Clear the status register
    GpibWrite("*SRE 16"); // Set the MAV bit of SRER

    // Perform the measurement
    GpibTimeout(LONG_TIME);
    GpibWrite("READ:ADEMod:FM?");
    WaitMAV(); // Wait for the MAV bit set
    GpibTimeout(NORMAL_TIME);

    // Get measurement results and save them to the file fm
    GpibReadFile("fm");
}
```

```
// Wait for the OPC (Operation complete) bit set
void
WaitOPC(void)
{
    int statusByte;

    // Wait for SRQ
    GpibWait(RQS);
    if (GpibStatus & TIMO)
    {
        fprintf(stderr, "Timeout occurred in waiting
            SRQ cycle.\n");
        GpibExit(0);
    }

    // Serial poll
    statusByte = GpibSerialPoll();
    if (statusByte & ESB)
    {
        printf("ESB bit is TRUE\n");
        GpibWrite("*ESR?");
        GpibRead(readBuf, MAX_BUF);
        printf("Standard Event Status Register = %s\n", readBuf);
    }
    if (statusByte & MAV)
        printf("MAV bit is TRUE\n");
    if (statusByte & EAV)
        printf("EAV bit is TRUE\n");
}
```

```
// Wait for the MAV (Message Available) bit set
void
WaitMAV(void)
{
    int statusByte;

    // Wait for SRQ
    GpibWait(RQS);
    if (GpibStatus & TIMO)
    {
        fprintf(stderr, "Timeout occurred in waiting SRQ
            cycle.\n");
        GpibExit(0);
    }

    // Serial poll
    statusByte = GpibSerialPoll();
    if (statusByte & MAV)
        printf("MAV bit is TRUE\n");
    if (statusByte & EAV)
        printf("EAV bit is TRUE\n");
}
```

```

// Open the GPIB device
void
GpibOpen(char *device)
{
    // Assign ID to the device and interface board,
    // and check on error.
    GpibDevice = ibfind(device);
    if (ibsta & ERR)
    {
        GpibError("ibfind Error: Unable to find device");
        GpibExit(0);
    }
    GpibBoard = ibfind(BOARD_NAME);
    if (ibsta & ERR)
    {
        GpibError("ibfind Error: Unable to find board");
        GpibExit(0);
    }

    // Clear the device and check on error.
    ibclr(GpibDevice);
    if (ibsta & ERR)
    {
        GpibError("ibclr Error: Unable to clear device");
        GpibExit(0);
    }
    ibsre(GpibBoard, 0);
    if (ibsta & ERR)
    {
        GpibError("ibclr Error: Unable to clear board");
        GpibExit(0);
    }

    // Set the timeout to 10 seconds (NORMAL_TIME)
    GpibTimeOut(NORMAL_TIME);
}

// Close the GPIB device
void
GpibClose(void)
{
    // Turn off the device and interface board
    ibonl(GpibDevice, 0);
    ibonl(GpibBoard, 0);
}

```

```
// End the program
void
GpibExit(int code)
{
    GpibClose();
    exit(code);
}

// Send string to the device and wait for the completion
void
GpibWrite(char *string)
{
    int count = strlen(string);

    // Send the string
    ibwrt(GpibDevice, string, count);

    // Determine the I/O completion of ibwrt
    if (ibsta & ERR)
    {
        GpibError("ibwrt I/O Error:");
        GpibExit(0);
    }
    else
    {
        GpibCount = ibcnt;
        GpibStatus = ibsta;
        if (GpibSerialPoll() & EAV)
        {
            ibwrt(GpibDevice, "SYSTEM:ERROR:ALL?",
                strlen("SYSTEM:ERROR:ALL?"));
            ibrd(GpibDevice, readBuf, MAX_BUF);
            fprintf(stderr, "%s\n", readBuf);
        }
    }
}
```

```

// Read response from the device
void
GpibRead(char *resp, int count)
{
    ibrd(GpibDevice, resp, count);

    if (ibsta & ERR)
    {
        GpibError("ibrd I/O Error:");
        GpibExit(0);
    }
    else
    {
        resp[ibcnt] = '\0';
        GpibCount = ibcnt;
        GpibStatus = ibsta;
    }
}

// Read response from the device and write it to a file
void
GpibReadFile(char *filename)
{
    ibrdf(GpibDevice, filename);

    if (ibsta & ERR)
    {
        GpibError("ibrdf I/O Error:");
        GpibExit(0);
    }
    else
    {
        GpibStatus = ibsta;
    }
}

```



```
// Read the status byte
int
GpibSerialPoll(void)
{
    char poll = 0;

    ibrsp(GpibDevice, &poll);
    if (ibsta & ERR)
    {
        GpibError("ibrsp Error:");
        GpibExit(0);
    }
    else
    {
        GpibStatus = ibsta;
    }

    return poll & 0xff;
}

// Set timeout
void
GpibTimeOut(int timeout)
{
    ibtmo(GpibDevice, timeout);
    if (ibsta & ERR)
    {
        GpibError("ibtmo Error:");
        GpibExit(0);
    }
    else
    {
        GpibStatus = ibsta;
    }
}
```

```

// Wait for the specified event
void
GpibWait(int wait)
{
    ibwait(GpibDevice, wait | TIMO);
    if (ibsta & (ERR | TIMO))
    {
        GpibError("ibwait Error:");
    }
    GpibStatus = ibsta;
}

// Display error message by ibsta
void
GpibError(char *errorMessage)
{
    fprintf (stderr, "%s\n", errorMessage);
    fprintf (stderr, "ibsta=(%X)h <", ibsta);

    if (ibsta & ERR ) fprintf (stderr, " ERR");
    if (ibsta & TIMO) fprintf (stderr, " TIMO");
    if (ibsta & END ) fprintf (stderr, " END");
    if (ibsta & SRQI) fprintf (stderr, " SRQI");
    if (ibsta & RQS ) fprintf (stderr, " RQS");
    if (ibsta & CMPL) fprintf (stderr, " CMPL");
    if (ibsta & LOK ) fprintf (stderr, " LOK");
    if (ibsta & REM ) fprintf (stderr, " REM");
    if (ibsta & CIC ) fprintf (stderr, " CIC");
    if (ibsta & ATN ) fprintf (stderr, " ATN");
    if (ibsta & TACS) fprintf (stderr, " TACS");
    if (ibsta & LACS) fprintf (stderr, " LACS");
    if (ibsta & DTAS) fprintf (stderr, " DTAS");
    if (ibsta & DCAS) fprintf (stderr, " DCAS");

    fprintf (stderr, " >\n");
    fprintf (stderr, "iberr= %d", iberr);
}

```

```
if (iberr == EDVR) fprintf (stderr,
    " EDVR <DOS Error>\n");
if (iberr == ECIC) fprintf (stderr,
    " ECIC <Not CIC>\n");
if (iberr == ENOL) fprintf (stderr,
    " ENOL <No Listener>\n");
if (iberr == EADR) fprintf (stderr,
    " EADR <Address error>\n");
if (iberr == EARG) fprintf (stderr,
    " EARG <Invalid argument>\n");
if (iberr == ESAC) fprintf (stderr,
    " ESAC <Not Sys Ctrlr>\n");
if (iberr == EABO) fprintf (stderr,
    " EABO <Op. aborted>\n");
if (iberr == ENEB) fprintf (stderr,
    " ENEB <No GPIB board>\n");
if (iberr == EOIP) fprintf (stderr,
    " EOIP <Async I/O in prg>\n");
if (iberr == ECAP) fprintf (stderr,
    " ECAP <No capability>\n");
if (iberr == EFSO) fprintf (stderr,
    " EFSO <File sys. error>\n");
if (iberr == EBUS) fprintf (stderr,
    " EBUS <Command error>\n");
if (iberr == ESTB) fprintf (stderr,
    " ESTB <Status byte lost>\n");
if (iberr == ESRQ) fprintf (stderr,
    " ESRQ <SRQ stuck on>\n");
}
```

Macro Program Execution Sample

This section shows a macro program execution sample. The macro programs are installed under the following directories in the analyzer:

- Macros specific to a user:
`C:\Program Files\Tektronix\wca200a\Python\wca200a\measmacro\nonregistered`
- Macros included in a option:
`C:\Program Files\Tektronix\wca200a\Python\wca200a\measmacro\registered`

In the example below, the following macro folders are placed in these directories:

MacroTest1, MacroTest2, and MacroTest3 under the *nonregistered* directory
 MacroTest1, MacroTest4, and MacroTest5 under the *registered* directory

The MacroTest1 macro folder contains macro commands test1, test2, and test3.

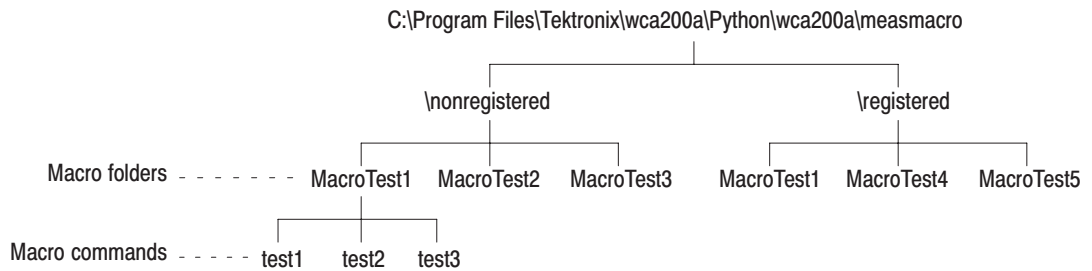

Figure 4-1: Saving the macro programs

Suppose that the following variables have been defined in the macro command test1:

- LOW_LIMIT, HIGH_LIMIT (numeric parameters)
- ERROR_MESSAGE (character string parameter)
- RESULT (measurement results (numeric values))

The following is an example of sending and responding commands:

```
[Send]      PROG:CAT?      // Query the list of the macro program
[Response]  "NONREGISTERED.MACROTEST1",
            "NONREGISTERED.MACROTEST2",
            "NONREGISTERED.MACROTEST3",
            "REGISTERED.MACROTEST1",
            "REGISTERED.MACROTEST4",
            "REGISTERED.MACROTEST5"

[Send]      PROG:NAME "NONREGISTERED.MACROTEST1"
            // Specify the macro program

[Send]      PROG:NUMB "LOW_LIMIT",1.5 // Set LOW_LIMIT to 1.5
[Send]      PROG:NUMB "HIGH_LIMIT",20 // Set HIGH_LIMIT to 20
[Send]      PROG:STR "ERROR_MESSAGE","Unsuccessful"
            // Set ERROR_MESSAGE

[Send]      PROG:EXEC "TEST1" // Run the macro command
[Send]      PROG:NUMB? "RESULT" // Retrieve the results
[Response]  1.2345
[Send]      PROG:DEL      // Delete the macro program from memory
```

Appendices



Appendix A: Character Charts

The ASCII and GPIB code chart is shown in Table A-1 on page A-2.

Table A-1: ASCII & GPIB code chart

B7 B6 B5 BITS B4 B3 B2 B1	0 0 0		0 0 1		0 1 0		0 1 1		1 0 0		1 0 1		1 1 0		1 1 1	
	CONTROL				NUMBERS SYMBOLS				UPPER CASE				LOWER CASE			
0 0 0 0	0 0	NUL	20 10	DLE	40 20	SP	60 30	0	100 40	TA0	120 50	P	140 60	SA0	160 70	SA16 p
0 0 0 1	1 1	GTL SOH	21 11	LL0 DC1	41 21	!	61 31	1	101 41	TA1	121 51	Q	141 61	SA1	161 71	SA17 q
0 0 1 0	2 2	STX	22 12	DC2	42 22	"	62 32	2	102 42	TA2	122 52	R	142 62	SA2	162 72	SA18 r
0 0 1 1	3 3	ETX	23 13	DC3	43 23	#	63 33	3	103 43	TA3	123 53	S	143 63	SA3	163 73	SA19 s
0 1 0 0	4 4	SDC EOT	24 14	DCL DC4	44 24	\$	64 34	4	104 44	TA4	124 54	T	144 64	SA4	164 74	SA20 t
0 1 0 1	5 5	PPC ENQ	25 15	PPU NAK	45 25	%	65 35	5	105 45	TA5	125 55	U	145 65	SA5	165 75	SA21 u
0 1 1 0	6 6	ACK	26 16	SYN	46 26	&	66 36	6	106 46	TA6	126 56	V	146 66	SA6	166 76	SA22 v
0 1 1 1	7 7	BEL	27 17	ETB	47 27	'	67 37	7	107 47	TA7	127 57	W	147 67	SA7	167 77	SA23 w
1 0 0 0	10 8	GET BS	30 18	SPE CAN	50 28	(70 38	8	110 48	TA8	130 58	X	150 68	SA8	170 78	SA24 x
1 0 0 1	11 9	TCT HT	31 19	SPD EM	51 29)	71 39	9	111 49	TA9	131 59	Y	151 69	SA9	171 79	SA25 y
1 0 1 0	12 A	LF	32 1A	SUB	52 2A	*	72 3A	:	112 4A	TA10	132 5A	Z	152 6A	SA10	172 7A	SA26 z
1 0 1 1	13 B	VT	33 1B	ESC	53 2B	+	73 3B	;	113 4B	TA11	133 5B	[153 6B	SA11	173 7B	SA27 {
1 1 0 0	14 C	FF	34 1C	FS	54 2C	,	74 3C	<	114 4C	TA12	134 5C	\	154 6C	SA12	174 7C	SA28
1 1 0 1	15 D	CR	35 1D	GS	55 2D	-	75 3D	=	115 4D	TA13	135 5D]	155 6D	SA13	175 7D	SA29 }
1 1 1 0	16 E	SO	36 1E	RS	56 2E	.	76 3E	>	116 4E	TA14	136 5E	^	156 6E	SA14	176 7E	SA30 ~
1 1 1 1	17 F	SI	37 1F	US	57 2F	/	77 3F	?	117 4F	TA15	137 5F	_	157 6F	SA15	177 7F	SA30 RUBOUT (DEL)
		ADDRESSED COMMANDS		UNIVERSAL COMMANDS		LISTEN ADDRESSES		TALK ADDRESSES		SECONDARY ADDRESSES OR COMMANDS						

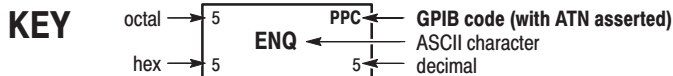

Tektronix
 REF: ANSI STD X3.4-1977
 IEEE STD 488.1-1987
 ISO STD 646-2973

Appendix B: GPIB Interface Specification

This appendix lists and describes the GPIB functions and messages the waveform generator implements.

Interface Functions

Table B–1 lists the GPIB interface functions this instrument implements. Each function is briefly described on page B–2.

Table B–1: GPIB interface function implementation

Interface function	Implemented subset	Capability
Source Handshake (SH)	SH1	Complete
Acceptor Handshake (AH)	AH1	Complete
Talker (T)	T6	Basic Talker, Serial Poll Unaddress if my-listen-address (MLA) No Talk Only mode
Listener (L)	L4	Basic Listener Unaddress if my talk address (MTA) No Listen Only mode
Service Request (SR)	SR1	Complete
Remote/Local (RL)	RL0	None
Parallel Poll (PP)	PP0	None
Device Clear (DC)	DC1	Complete
Device Trigger (DT)	DT0	None
Controller (C)	C0	None
Electrical Interface	E2	Three-state driver

- Source Handshake (SH). Enables a talking device to support the coordination of data transfer. The SH function controls the initiation and termination of data byte transfers.
- Acceptor Handshake (AH). Enables a listening device to coordinate data reception. The AH function delays data transfer initiation or termination until the listening device is ready to receive the next data byte.
- Talker (T). Enables a device to send device-dependent data over the interface. This capability is available only when the device is addressed to talk, and uses a one-byte address.
- Listener (L). Enables a device to receive device-dependent data over the interface. This capability is available only when the device is addressed to listen, and uses a one-byte address.
- Service Request (SR). Enables a device to assert an SRQ (Service Request) line to notify the controller when it requires service.
- Remote/Local (RL). Enables a device to respond to both the GTL (Go To Local) and LLO (Local Lock Out) interface messages.
- Parallel Poll (PP). Enables a device to respond to the following interface messages: PPC, PPD, PPE, and PPU, as well as to send out a status message when the ATN (Attention) and EOI (End or Identify) lines are asserted simultaneously.
- Device Clear (DC). Enables a device to be cleared or initialized, either individually, or as part of a group of devices.
- Device Trigger (DT). Enables a device to respond to the GET (Group Execute Trigger) interface message when acting as a listener.
- Controller (C). Enables a device that has this capability to send its address, universal commands, and addressed commands to other devices over the interface.
- Electrical Interface (E). Identifies the electrical interface driver type. The notation E1 means the electrical interface uses open collector drivers, E2 means the electrical interface uses three-state drivers.

Interface Messages

Table B-2 shows the standard interface messages that are supported by the analyzer.

Table B-2: Standard interface messages

Message	Type	Implemented
Device Clear (DCL)	UC	Yes
Local Lockout (LLO)	UC	No
Serial Poll Disable (SPD)	UC	Yes
Serial Poll Enable (SPE)	UC	Yes
Parallel Poll Unconfigure (PPU)	UC	No
Go To Local (GTL)	AC	Yes
Selected Device Clear (SDC)	AC	Yes
Group Execute Trigger (GET)	AC	No
Take Control (TCT)	AC	No
Parallel Poll Configure (PPC)	AC	No

UC: Universal command; AC: Address command

- Device Clear (DCL). Will clear (initialize) all devices on the bus that have a device clear function, whether or not the controller has addressed them.
- Local Lockout (LLO). Disables the return to local function.
- Serial Poll Disable (SPD). Changes all devices on the bus from the serial poll state to the normal operating state.
- Serial Poll Enable (SPE). Puts all bus devices that have a service request function into the serial poll enabled state. In this state, each device sends the controller its status byte, instead of its normal output, after the device receives its talk address on the data lines. This function may be used to determine which device sent a service request.
- Go To Local (GTL). Causes the listen-addressed device to switch from remote to local (front-panel) control.
- Select Device Clear (SDC). Clears or initializes all listen-addressed devices.
- Group Execute Trigger (GET). Triggers all applicable devices and causes them to initiate their programmed actions.
- Take Control (TCT). Allows the controller in charge to pass control of the bus to another controller on the bus.
- Parallel Poll Configure (PPC). Causes the listen-addressed device to respond to the secondary commands Parallel Poll Enable (PPE) and Parallel Poll Disable (PPD), which are placed on the bus following the PPC command. PPE enables a device with parallel poll capability to respond on a particular data line. PPD disables the device from responding to the parallel poll.

Appendix C: Factory Initialization Settings

The factory initialization settings provide you a known state for the analyzer. The *RST command returns the instrument settings to the factory defaults for the measurement mode specified with :INSTRument[:SElect]. Factory initialization sets values as shown in Table C-1 through C-11. The column to the far right shows the measurement modes in which the command is available.

Table C-1: Factory initialization settings — IEEE common commands

Header	Default value
*ESE	0
*OPC	0
*SRE	0

Table C-2: Factory initialization settings — :CALCulate commands

Header	Default value
:CALCulate<x>:DLINe<y>	0
:CALCulate<x>:DLINe<y>:STATe	OFF
:CALCulate<x>:MARKer<y>:MODE	POSITION
:CALCulate<x>:MARKer<y>:T	0
:CALCulate<x>:MARKer<y>:TRACe	MAIN
:CALCulate<x>:MARKer<y>:X	0
:CALCulate<x>:MARKer<y>:Y	0
:CALCulate<x>:VLINe<y>	0
:CALCulate<x>:VLINe<y>:STATe	OFF

Table C-3: Factory initialization settings — :CALibration commands

Header	Default value
:CALibration:AUTO	OFF

Table C-4: Factory initialization settings — :DISPlay commands

Header	Default value
:DISPlay:CCDF subgroup	
:DISPlay:CCDF:LINE:GAUSSian[:STATe]	ON
:DISPlay:CCDF:LINE:REFerence[:STATe]	OFF
:DISPlay:CCDF:X[:SCALe]:AUTO	ON
:DISPlay:CCDF:X[:SCALe]:MAXimum	15 dB
:DISPlay:CCDF:X[:SCALe]:OFFSet	0 dB
:DISPlay:CCDF:Y[:SCALe]:MAXimum	1E-7
:DISPlay:CCDF:Y[:SCALe]:MINimum	100%
:DISPlay:DDEMod subgroup (Option 21 only)	
:DISPlay:DDEMod:CCDF:LINE:GAUSSian[:STATe]	ON
:DISPlay:DDEMod:MView:DStArt	AUTO
:DISPlay:DDEMod:MView:FORMat	OFF
:DISPlay:DDEMod:MView:HSSHift	0
:DISPlay:DDEMod:MView:RADIx	BINary
:DISPlay:DDEMod:MView:Y[:SCALe]:MAXimum	100%
:DISPlay:DDEMod:MView:Y[:SCALe]:MINimum	1m%
:DISPlay:DDEMod:MView:Y[:SCALe]:OFFSet	0
:DISPlay:DDEMod:MView:Y[:SCALe]:RANGe	0
:DISPlay:DDEMod:NLINearity:LINE:BFIT[:STATe]	ON
:DISPlay:DDEMod:NLINearity:LINE:REFerence[:STATe]	ON
:DISPlay:DDEMod:NLINearity:MASK[:STATe]	ON
:DISPlay:DDEMod:SVIew:DStArt	AUTO
:DISPlay:DDEMod:SVIew:FORMat	SPECTrum
:DISPlay:DDEMod:SVIew:RADIx	BINary
:DISPlay:DDEMod:SVIew:Y[:SCALe]:MAXimum	100%
:DISPlay:DDEMod:SVIew:Y[:SCALe]:MINimum	1m%
:DISPlay:DDEMod:SVIew:Y[:SCALe]:OFFSet	0
:DISPlay:DDEMod:SVIew:Y[:SCALe]:RANGe	0

Table C-4: Factory initialization settings — :DISPlay commands (Cont.)

Header	Default value
:DISPlay:OVlew subgroup	
:DISPlay:OVlew:FORMat	WAVeform
:DISPlay:OVlew:OTINdicator	OFF
:DISPlay:OVlew:SGRam:COLor[:SCALe]:OFFSet	-100 dBm
:DISPlay:OVlew:SGRam:COLor[:SCALe]:RANGe	100 dB
:DISPlay:OVlew:SGRam:X[:SCALe]:OFFSet	1.4925 GHz
:DISPlay:OVlew:SGRam:X[:SCALe]:SPAN	15 MHz
:DISPlay:OVlew:SGRam:Y[:SCALe]:OFFSet	0
:DISPlay:OVlew:SGRam:Y[:SCALe]:PLINe	1
:DISPlay:OVlew:WAVeform:X[:SCALe]:OFFSet	-40 ms
:DISPlay:OVlew:WAVeform:X[:SCALe]:PDIVision	4 ms/div
:DISPlay:OVlew:WAVeform:Y[:SCALe]:OFFSet	-100 dBm
:DISPlay:OVlew:WAVeform:Y[:SCALe]:PDIVision	100 dB
:DISPlay:PULSe subgroup	
:DISPlay:PULSe:MVlew:RESult:CHPower	OFF
:DISPlay:PULSe:MVlew:RESult:DCYCLE	OFF
:DISPlay:PULSe:MVlew:RESult:EBWidth	OFF
:DISPlay:PULSe:MVlew:RESult:FREQuency	OFF
:DISPlay:PULSe:MVlew:RESult:OBWidth	OFF
:DISPlay:PULSe:MVlew:RESult:OORatio	OFF
:DISPlay:PULSe:MVlew:RESult:PERiod	OFF
:DISPlay:PULSe:MVlew:RESult:PHASe	OFF
:DISPlay:PULSe:MVlew:RESult:PPOWer	OFF
:DISPlay:PULSe:MVlew:RESult:RIPPlE	OFF
:DISPlay:PULSe:MVlew:RESult:WIDTh	ON
:DISPlay:PULSe:SVlew:FORMat	WIDTh
:DISPlay:PULSe:SVlew:GUIDelines	ON
:DISPlay:PULSe:SVlew:RANGe	ADAPtive
:DISPlay:PULSe:SVlew:RESult	SINGLE
:DISPlay:PULSe:SVlew:SElect	0

Table C-4: Factory initialization settings — :DISPlay commands (Cont.)

Header	Default value
:DISPlay:SPECtrum subgroup	
:DISPlay:SPECtrum:BMARker:STATe	ON
:DISPlay:SPECtrum:GRATicule:GRID	FIX
:DISPlay:SPECtrum:MLINe:AMPLitude:INTerval	0 dB
:DISPlay:SPECtrum:MLINe:AMPLitude:OFFSet	0 dBm
:DISPlay:SPECtrum:MLINe:AMPLitude[:STATe]	OFF
:DISPlay:SPECtrum:MLINe:ANNotation[:STATe]	ON
:DISPlay:SPECtrum:MLINe:FREQuency:INTerval	0 Hz
:DISPlay:SPECtrum:MLINe:FREQuency:OFFSet	Center frequency
:DISPlay:SPECtrum:MLINe:FREQuency[:STATe]	OFF
:DISPlay:SPECtrum:X[:SCALe]:OFFSet	1.4925 GHz
:DISPlay:SPECtrum:X[:SCALe]:PDIVision	1.5 MHz/div
:DISPlay:SPECtrum:Y[:SCALe]:OFFSet	-100 dBm
:DISPlay:SPECtrum:Y[:SCALe]:PDIVision	10 dB/div
:DISPlay:TFRrequency subgroup	
:DISPlay:TFRrequency:SGRam:COLor[:SCALe]:OFFSet	-100 dBm
:DISPlay:TFRrequency:SGRam:COLor[:SCALe]:RANGe	100 dB
:DISPlay:TFRrequency:SGRam:MLINe:ANNotation[:STATe]	ON
:DISPlay:TFRrequency:SGRam:MLINe:FREQuency:INTerval	0 Hz
:DISPlay:TFRrequency:SGRam:MLINe:FREQuency:OFFSet	Center frequency
:DISPlay:TFRrequency:SGRam:MLINe:FREQuency[:STATe]	OFF
:DISPlay:TFRrequency:SGRam:MLINe:TIME:INTerval	0 s
:DISPlay:TFRrequency:SGRam:MLINe:TIME:OFFSet	10 ms
:DISPlay:TFRrequency:SGRam:MLINe:TIME[:STATe]	OFF
:DISPlay:TFRrequency:SGRam:X[:SCALe]:OFFSet	1.4925 GHz
:DISPlay:TFRrequency:SGRam:X[:SCALe]:SPAN	15 MHz
:DISPlay:TFRrequency:SGRam:Y[:SCALe]:OFFSet	0
:DISPlay:TFRrequency:SGRam:Y[:SCALe]:PLINe	1

Table C-4: Factory initialization settings — :DISPlay commands (Cont.)

Header	Default value
:DISPlay[:VIEW] subgroup	
:DISPlay[:VIEW]:BRIGhtness	100
:DISPlay[:VIEW]:FORMat	V1S (SANORMAL) MULTitude (Other than above)
:DISPlay:WAVEform subgroup	
:DISPlay:WAVEform:X[:SCALe]:OFFSet	-160 ms
:DISPlay:WAVEform:X[:SCALe]:PDIVision	16 ms/div
:DISPlay:WAVEform:Y[:SCALe]:OFFSet	0
:DISPlay:WAVEform:Y[:SCALe]:PDIVision	0

Table C-5: Factory initialization settings — :FORMat commands

Header	Default value
:FORMat:BORDER	NORMal
:FORMat[:DATA]	REAL,32

Table C-6: Factory initialization settings — :INITiate commands

Header	Default value
:INITiate:CONTinuous	OFF

Table C-7: Factory initialization settings — :INPut commands

Header	Default value
:INPut:ATTenuation	20 dB
:INPut:ATTenuation:AUTO	ON
:INPut:COUPling	AC
:INPut:MAXLevel	0 dB
:INPut:MIXer	-25 dBm

Table C-8: Factory initialization settings — :SENSe commands

Header	Default value
[:SENSe]:ACPower subgroup	
[:SENSe]:ACPower:BANDwidth BWIDth:ACHannel	1.5 MHz
[:SENSe]:ACPower:BANDwidth BWIDth:INtegration	1.5 MHz
[:SENSe]:ACPower:CSPacing	2.1MHz
[:SENSe]:ACPower:FILTer:TYPE	NYQuist
[:SENSe]:ACPower:FILTer:COEFFicient	0.5
[:SENSe]:ADEMod subgroup	
[:SENSe]:ADEMod:BLOCK	0
[:SENSe]:ADEMod:CARRier:OFFSet	0
[:SENSe]:ADEMod:CARRier:SEARch	ON
[:SENSe]:ADEMod:FM:THReshold	-100 dB
[:SENSe]:ADEMod:LENGth	8192
[:SENSe]:ADEMod:MODulation	OFF
[:SENSe]:ADEMod:OFFSet	0
[:SENSe]:ADEMod:PM:THReshold	-100 dB
[:SENSe]:AVERage subgroup	
[:SENSe]:AVERage:COUNT	20
[:SENSe]:AVERage[:STATe]	OFF
[:SENSe]:AVERage:TCONtrol	EXPonential
[:SENSe]:BSIZe subgroup	
[:SENSe]:BSIZe	2
[:SENSe]:CCDF subgroup	
[:SENSe]:CCDF:BLOCK	0
[:SENSe]:CCDF:THReshold	-150 dBm
[:SENSe]:CFRequency subgroup	
[:SENSe]:CFRequency:CRESolution	1 Hz
[:SENSe]:CHPower subgroup	
[:SENSe]:CHPower:BANDwidth BWIDth:INtegration	3 MHz
[:SENSe]:CHPower:FILTer:COEFFicient	0.5
[:SENSe]:CHPower:FILTer:TYPE	NYQuist

Table C-8: Factory initialization settings — :SENSE commands (Cont.)

Header	Default value
[:SENSE]:CNRatio subgroup	
[:SENSE]:CNRatio:BANDwidth BWIDTH:INTegration	1.5 MHz
[:SENSE]:CNRatio:BANDwidth BWIDTH:NOISe	1.5 MHz
[:SENSE]:CNRatio:FILTer:COEFFicient	0.5
[:SENSE]:CNRatio:FILTer:TYPE	NYQuist
[:SENSE]:CNRatio:OFFSet	4.5 MHz
[:SENSE]:CORRection subgroup	
[:SENSE]:CORRection:OFFSet[:MAGNitude]	0
[:SENSE]:CORRection:OFFSet:FREQUency	0
[:SENSE]:CORRection[:STATE]	OFF
[:SENSE]:CORRection:X:SPACing	LINear
[:SENSE]:CORRection:Y:SPACing	LOGarithmic
[:SENSE]:DDEMod subgroup (Option 21 only)	
[:SENSE]:DDEMod:BLOCK	0
[:SENSE]:DDEMod:CARRier:OFFSet	0
[:SENSE]:DDEMod:CARRier:SEARch	ON
[:SENSE]:DDEMod:FILTer:ALPHA	0.3
[:SENSE]:DDEMod:FILTer:MEASurement	OFF
[:SENSE]:DDEMod:FILTer:REFerence	GAUSSian
[:SENSE]:DDEMod:FORMat	GMSK
[:SENSE]:DDEMod:LENGth	7680
[:SENSE]:DDEMod:NLINearity:COEFFicient	8
[:SENSE]:DDEMod:NLINearity:HDIVision	0.1
[:SENSE]:DDEMod:NLINearity:LSRegion[:SET]	-10
[:SENSE]:DDEMod:NLINearity:LSRegion:UNIT	RELative
[:SENSE]:DDEMod:OFFSet	0
[:SENSE]:DDEMod:PRESet	OFF
[:SENSE]:DDEMod:SRATe	270.833 ksp/s
[:SENSE]:EBWidth subgroup	
[:SENSE]:EBWidth:XDB	-30 dB
[:SENSE]:FEED subgroup	
[:SENSE]:FEED	RF

Table C-8: Factory initialization settings — :SENSe commands (Cont.)

Header	Default value
[:SENSe]:FREQuency subgroup	
[:SENSe]:FREQuency:CENTer	1.5 GHz
[:SENSe]:FREQuency:CENTer:STEP:AUTO	ON
[:SENSe]:FREQuency:CENTer:STEP[:INCRement]	150 kHz
[:SENSe]:FREQuency:CTABLE[:SELect]	None
[:SENSe]:FREQuency:SPAN	15 MHz
[:SENSe]:FREQuency:STARt	1.4925 GHz
[:SENSe]:FREQuency:STOP	1.5075 GHz
[:SENSe]:OBWidth subgroup	
[:SENSe]:OBWidth:PERCent	99%
[:SENSe]:PULSe subgroup	
[:SENSe]:PULSe:BLOCK	0
[:SENSe]:PULSe:CHPower:BANDwidth[:BWIDTH:INTEgration]	1 MHz
[:SENSe]:PULSe:CRESolution	1 kHz
[:SENSe]:PULSe:EBWidth:XDB	-30 dB
[:SENSe]:PULSe:FILTer:COEFFicient	0.35
[:SENSe]:PULSe:FILTer:BANDwidth BWIDTH	3.6 MHz
[:SENSe]:PULSe:FILTer:MEASuement	OFF
[:SENSe]:PULSe:FILTer:OBWidth:PERcent	90%
[:SENSe]:PULSe:PTOFset	0
[:SENSe]:PULSe:THReshold	-3 dBc
[:SENSe]:ROSCillator subgroup	
[:SENSe]:ROSCillator:SOURce	INTernal
[:SENSe]:SPECtrum subgroup	
[:SENSe]:SPECtrum:AVERage:COUNT	20
[:SENSe]:SPECtrum:AVERage[:STATe]	OFF
[:SENSe]:SPECtrum:AVERage:TYPE	RMS
[:SENSe]:SPECtrum:BANDwidth BWIDTH[:RESolution]	80 kHz
[:SENSe]:SPECtrum:BANDwidth BWIDTH[:RESolution]:AUTO	ON
[:SENSe]:SPECtrum:BANDwidth BWIDTH:STATe	ON
[:SENSe]:SPECtrum:DETEctor[:FUNCTion]	POSitive
[:SENSe]:SPECtrum:FILTer:COEFFicient	0.5
[:SENSe]:SPECtrum:FILTer:TYPE	NYQuist

Table C-8: Factory initialization settings — :SENSE commands (Cont.)

Header	Default value
[[:SENSE]:SPECTrum:FFT:ERESolution]	OFF
[[:SENSE]:SPECTrum:FFT:LENGth]	1024
[[:SENSE]:SPECTrum:FFT:STARt]	1024
[[:SENSE]:SPECTrum:FFT:WINDow[:TYPE]]	BH4B
[[:SENSE]:SPECTrum:FRAMe]	0
[[:SENSE]:SPECTrum:MEASurement]	OFF
[[:SENSE]:SPURious subgroup]	
[[:SENSE]:SPURious[:THReshold]:EXCURsion]	3 dB
[[:SENSE]:SPURious[:THReshold]:IGNore]	0 Hz
[[:SENSE]:SPURious[:THReshold]:SIGNal]	-20 dBm
[[:SENSE]:SPURious[:THReshold]:SPURious]	-70 dB
[[:SENSE]:TRANSient subgroup]	
[[:SENSE]:TRANSient:BLOCK]	0
[[:SENSE]:TRANSient:ITEM]	OFF
[[:SENSE]:TRANSient:LENGth]	8192
[[:SENSE]:TRANSient:OFFSet]	0

Table C-9: Factory initialization settings — :STATus commands

Header	Default value
:STATus:OPERation:ENABle	0
:STATus:QUESTionable:ENABle	0
:SYSTem:QUESTionable[:EVENT]	0

Table C-10: Factory initialization settings — :TRACe commands

Header	Default value
:TRACe<x>:MODE	NORMal
:TRACe<x>:DDEtector	MAXimum
:TRACe<x>:AVERAge:COUNT	20

Table C-11: Factory initialization settings — :TRIGger commands

Header	Default value
:TRIGger[:SEQuence]:LEVel:IF	50%
:TRIGger[:SEQuence]:LEVel:IQFRequency	0,0,... (1198 of zeros)
:TRIGger[:SEQuence]:LEVel:IQTime	-40 dBfs
:TRIGger[:SEQuence]:MODE	AUTO
:TRIGger[:SEQuence]:POSition	50%
:TRIGger[:SEQuence]:SLOPe	Rise
:TRIGger[:SEQuence]:SOURce	IF

Table C-12: Factory initialization settings — :UNIT commands

Header	Default value
:UNIT:ANGLE	DEG

Appendix D: Setting Range

This section lists the setting range of the horizontal and vertical scale for the views, and of RBW (Resolution Bandwidth).

Display Format and Scale

Table D-1: Display format and scale

Display format	Horizontal range	Vertical range
Spectrum	0 Hz to 3 GHz (RSA3303A) 0 Hz to 8 GHz (RSA3308A)	-200 to +100 dBm
Spectrogram	0 Hz to 3 GHz (RSA3303A) 0 Hz to 8 GHz (RSA3308A)	Frame -15999 to 0 Frame -63999 to 0 (Option 02)
Time domain view	$-(T_f \times N_f)$ to 0 s *	-200 to +100 dBm (Amplitude) -30 to +30 V (I/Q level) -300 to +300% (AM) -38.4 to +38.4 MHz (FM/FVT) -675 to +675 deg. (PM)
CCDF	0 to 15.01 dB	10^{-9} to 100%
Constellation	$-(T_f \times N_f)$ to 0 s *	fixed
EVM	$-(T_f \times N_f)$ to 0 s *	-100 to +200% (EVM) -300 to +300% (amplitude error) -675 to +675 deg. (phase error)
Eye diagram	$-(T_f \times N_f)$ to 0 s *	fixed
Symbol table	0 to $(1024 \times N_f)$ symbols	NA

* T_f : Frame time; N_f : Frame number

RBW

The RBW setting range depends on span as shown in Table D–2.

Table D–2: RBW setting range

Span (Hz)	Default value (Hz) /[Number of samples]	Minimum value (Hz) /[Number of samples]	Maximum value (Hz) /[Number of samples]
50 to 100	2 [1024]	1 [2048]	10 [128]
120 to 200	5 [512]	1 [4096]	20 [128]
250 to 500	10 [1024]	1 [8192]	50 [128]
600 to 1 k	20 [1024]	1 [16384]	100 [128]
1.2 k to 2 k	50 [512]	2 [16384]	200 [128]
2.5 k to 5 k	100 [1024]	5 [16384]	500 [128]
6 k to 10 k	100 [2048]	10 [16384]	1 k [128]
12 k to 20 k	200 [2048]	20 [16384]	2 k [128]
30 k to 50 k	300 [4096]	50 [16384]	5 k [128]
60 k to 100 k	500 [4096]	100 [16384]	10 k [128]
120 k to 200 k	1 k [4096]	200 [16384]	20 k [128]
250 k to 500 k	2 k [2048]	500 [16384]	50 k [128]
600 k to 1 M	5 k [2048]	1 k [16384]	100 k [128]
1.2 M to 2 M	10 k [4096]	1 k [32768]	200 k [128]
2.5 M to 5 M	20 k [4096]	1 k [65536]	500 k [256]
6 M to 10 M	50 k [2048]	1 k [65536]	1 M [128]
15 M	80 k [4096]	2 k [65536]	2 M [256]
20 M to 40 M	100 k [1024*N]	10 k [8192*N]	2 M [64*N]
50 M to 80 M	300 k [512*N]	10 k [8192*N]	2 M [64*N]
100 M to 150 M	500 k [256*N]	10 k [8192*N]	10 M [64*N]
200 M to 400 M	1 M [128*N]	10 k [8192*N]	10 M [64*N]
500 M to 800 M	2 M [128*N]	20 k [4096*N]	10 M [64*N]
1 G to 1.5 G	5 M [128*N]	50 k [2048*N]	20 M [64*N]
2 G to 3 G	10 M [128*N]	100 k [1024*N]	30 M [64*N]

* **N: Number of multi-frames, that is the value rounded off [(span)/(10 MHz)] to the positive infinity.**

Appendix E: SCPI Conformance Information

All commands in the RSA3300 Series analyzers are based on SCPI Version 1999.0. Table E-1 through E-19 list all commands supported by the analyzer. The columns to the right show whether a command is defined in the SCPI 1999.0 Standard or not.

Table E-1: SCPI conformance information — IEEE common commands

Command	Defined in SCPI 1999.0	Not Defined in SCPI 1999.0
*CAL?	✓	
*CLS	✓	
*ESE	✓	
*ESR?	✓	
*IDN?	✓	
*OPC	✓	
*OPT?		✓
*RST	✓	
*SRE	✓	
*STB?	✓	
*TRG		✓
*TST?	✓	
*WAI	✓	

Table E-2: SCPI conformance information — :ABORt commands

Command	Defined in SCPI 1999.0	Not Defined in SCPI 1999.0
:ABORt	✓	

Table E-3: SCPI conformance information — :CALCulate commands

Command		Defined in SCPI 1999.0	Not Defined in SCPI 1999.0	
:CALCulate<x>	:DLINe<y>		✓	
	:STATe		✓	
	:MARKer[1]	:AOff		✓
		:MAXimum		✓
	:MODE		✓	
	:PEAK	:LEFT		✓
		:RIGHT		✓
	[:SET]	:CENTer		✓
		:MEASurement		✓
	:T		✓	
	:TOGGle		✓	
	:TRACe		✓	
	[:STATe]		✓	
	:X		✓	
	:Y		✓	
	:VLINe<y>			✓
:STATe			✓	

Table E-4: SCPI conformance information — :CALibration commands

Command		Defined in SCPI 1999.0	Not Defined in SCPI 1999.0	
:CALibration	[:ALL]?	✓		
	:AUTO	✓		
	:DATA	:DEFault		✓
	:OFFSet	:BASebanddc		✓
		:CENTer		✓
		:IQINput		✓
	:RF		✓	

Table E-5: SCPI conformance information — :CONFigure commands

Command			Defined in SCPI 1999.0	Not Defined in SCPI 1999.0	
:CONFigure	:ADEMod	:AM		✓	
		:FM		✓	
		:PM		✓	
	:CCDF			✓	
	:DDEMod			✓	
	:PULSe			✓	
	:SPECTrum	:ACPower			✓
		:CFRequency			✓
		:CHPower			✓
		:CNRatio			✓
		:EBWidth			✓
		:OBWidth			✓
		:SPURious			✓
	:TFRequency	:RTIME			✓
		:SGRam			✓
	:TRANsient	:FVTime			✓
		:IQVTime			✓
:PVTTime				✓	

Table E-6: SCPI conformance information — :DISPlay commands

Command				Defined in SCPI 1999.0	Not Defined in SCPI 1999.0
:DISPlay	:CCDF	:LINE	:GAUSSian [:STATe]		✓
			:REFerence [:STATe]		✓
			:STORe		✓
	:X	[:SCALe]	:AUTO		✓
			:MAXimum		✓
			:OFFSet		✓

Table E-6: SCPI conformance information — :DISPlay commands (Cont.)

Command					Defined in SCPI 1999.0	Not Defined in SCPI 1999.0
	:Y	[:SCALE]	:FIT			✓
			:FULL			✓
			:MAXimum			✓
			:MINimum			✓
:DDEMod	:CCDF	:LINE	:GAUSSian	[:STATE]		✓
	:MView	:DStart				✓
		:FORMat				✓
		:RADix				✓
		:X	[:SCALE]	:OFFSet		✓
				:RANGe		✓
		:Y	[:SCALE]	:FIT		✓
				:FULL		✓
				:MAXimum		✓
				:MINimum		✓
				:OFFSet		✓
				:RANGe		✓
	:NLINearity	:LINE	:BFIT	[:STATE]		✓
			:REFerence	[:STATE]		✓
		:MASK	[:STATE]			✓
	:SVIew	:DStart				✓
		:FORMat				✓
		:HSSHift				✓
		:RADix				✓
		:X	[:SCALE]	:OFFSet		✓
				:RANGe		✓
		:Y	[:SCALE]	:FIT		✓
				:FULL		✓
				:MAXimum		✓
				:MINimum		✓
				:OFFSet		✓
				:RANGe		✓

Table E-6: SCPI conformance information — :DISPlay commands (Cont.)

Command				Defined in SCPI 1999.0	Not Defined in SCPI 1999.0			
:OView	:FORMat				✓			
	:OTINdicator				✓			
	:SGRam	:COLor	[:SCALe]	:OFFSet		✓		
				:RANGe		✓		
				:X	[:SCALe]	:OFFSet		✓
	:Y	[:SCALe]	:OFFSet	:SPAN		✓		
				:PLINe		✓		
				:WAVEform	:X	[:SCALe]	:OFFSet	
	:PULSE	:MVIEW	:RESuLt	:PDIVision		✓		
				:Y	[:SCALe]	:FIT		✓
				:FULL		✓		
				:OFFSet		✓		
				:PDIVision		✓		
	:PULSE	:MVIEW	:RESuLt	:CHPower		✓		
				:DCYCLe		✓		
:EBWidth					✓			
:FREQuency					✓			
:OBWidth					✓			
:OORatio					✓			
:PERiod					✓			
:PHASe					✓			
:PPOWer					✓			
:RIPPIe					✓			
:WIDTh					✓			
:SVIEW				:FORMat			✓	
					:GUIDelines		✓	
					:RANGe		✓	
					:RESuLt		✓	
	:SElect		✓					

Table E-6: SCPI conformance information — :DISPlay commands (Cont.)

Command				Defined in SCPI 1999.0	Not Defined in SCPI 1999.0
:SPECTrum	:BMARKer	:STATE			✓
	:GRATicule	:GRID			✓
	:MLINe	:AMPLitude	:INTerval		✓
			:OFFSet		✓
			[:STATE]		✓
		:ANNotation	[:STATE]		✓
	:FREQuency	:INTerval	:OFFSet		✓
			[:STATE]		✓
			:PDIVision		✓
	:X	[:SCALE]	:OFFSet		✓
			:PDIVision		✓
	:Y	[:SCALE]	:FIT		✓
			:FULL		✓
			:OFFSet		✓
:PDIVision				✓	
:TFREquency	:SGRam	:COLor	[:SCALE]	:OFFSet	✓
			:RANGe		✓
	:MLINe	:ANNotation	[:STATE]		✓
			:FREQuency	:INTerval	✓
			:OFFSet		✓
			[:STATE]		✓
		:TIME	:INTerval		✓
		:OFFSet		✓	
		[:STATE]		✓	
	:X	[:SCALE]	:OFFSet		✓
:SPAN				✓	
:Y	[:SCALE]	:OFFSet		✓	
		:PLINe		✓	
[:VIEW]	:BRIGHtness			✓	
	:FORMat			✓	
:WAVEform	:X	[:SCALE]	:OFFSet		✓
			:PDIVision		✓

Table E-6: SCPI conformance information — :DISPlay commands (Cont.)

Command	Defined in SCPI 1999.0	Not Defined in SCPI 1999.0
:Y [:SCALe]		✓
:FIT		✓
:FULL		✓
:OFFSet		✓
:PDIVsiOn		✓

Table E-7: SCPI conformance information — :FETCh commands

Command	Defined in SCPI 1999.0	Not Defined in SCPI 1999.0
:FETCh :ADEMod :AM?		✓
:RESuLt?		✓
:FM?		✓
:RESuLt?		✓
:PM?		✓
:CCDF?		✓
:DDEMod?		✓
:DISTRibution :CCDF?		✓
:OVIew?		✓
:PULSe?		✓
:SPECTrum?		✓
:TAMPliTude?		✓
:SPECTrum :ACPoweR?		✓
:CFRequency?		✓
:CHPower?		✓
:CNRatio?		✓
:EBWidth?		✓
:OBWidth?		✓
:SPURious?		✓

Table E-7: SCPI conformance information — :FETCh commands (Cont.)

Command	Defined in SCPI 1999.0	Not Defined in SCPI 1999.0
:TRANsient		✓
:FVTime?		✓
:IQVTime?		✓
:PVTime?		✓
:UL3Gpp?		✓

Table E-8: SCPI conformance information — :HCOPy commands

Command	Defined in SCPI 1999.0	Not Defined in SCPI 1999.0
:HCOPy		✓
:BACKground		✓
:DESTination	✓	
[:IMMEDIATE]	✓	

Table E-9: SCPI conformance information — :INITiate commands

Command	Defined in SCPI 1999.0	Not Defined in SCPI 1999.0
:INITiate	✓	
:CONTInuous	✓	
[:IMMEDIATE]	✓	
:REStart	✓	

Table E-10: SCPI conformance information — :INPut commands

Command	Defined in SCPI 1999.0	Not Defined in SCPI 1999.0
:INPut :ALEVel		✓
:INPut :ATTenuation	✓	
:INPut :AUTO	✓	
:INPut :COUPling	✓	
:INPut :MIXer		✓
:INPut :MLEVel		✓

Table E-11: SCPI conformance information — :INSTrument commands

Command	Defined in SCPI 1999.0	Not Defined in SCPI 1999.0
:INSTrument :CATalog	✓	
:INSTrument [:SElect]	✓	

Table E-12: SCPI conformance information — :MMEMory commands

Command	Defined in SCPI 1999.0	Not Defined in SCPI 1999.0
:MMEMory :COPY	✓	
:MMEMory :DELeTe	✓	
:MMEMory :LOAD :CORRection		✓
:MMEMory :LOAD :IQT		✓
:MMEMory :LOAD :STATe		✓
:MMEMory :LOAD :TRACe		✓
:MMEMory :STORe :CORRection		✓
:MMEMory :STORe :IQT		✓
:MMEMory :STORe :STABle		✓
:MMEMory :STORe :STATe		✓
:MMEMory :STORe :TRACe		✓
:MMEMory :NAME	✓	

Table E-13: SCPI conformance information — :PROGram commands

Command	Defined in SCPI 1999.0	Not Defined in SCPI 1999.0
:PROGram		
:CATalog?	✓	
[:SElected]		
:DElete	✓	
[:SElected]		
:EXECute	✓	
:NAME	✓	
:NUMBer	✓	
:STRing	✓	

Table E-14: SCPI conformance information — :READ commands

Command	Defined in SCPI 1999.0	Not Defined in SCPI 1999.0
:READ		
:ADEMod		
:AM?		✓
:RESuIt?		✓
:FM?		✓
:RESuIt?		✓
:PM?		✓
:CCDF?		✓
:DDEMod?		✓
:DIStRiBution		
:CCDF?		✓
:OVIew?		✓
:PULSe?		✓
:SPECTrum?		✓
:TAMPlitude?		✓
:SPECTrum?		
:ACPower?		✓
:CFRequency?		✓
:CHPower?		✓
:CNRatio?		✓
:EBWidth?		✓
:OBWidth?		✓
:SPURious?		✓

Table E-14: SCPI conformance information — :READ commands (Cont.)

Command	Defined in SCPI 1999.0	Not Defined in SCPI 1999.0
:TRANsient :FVTime?		✓
:IQVTime?		✓
:PVTTime?		✓

Table E-15: SCPI conformance information — :SENSE commands

Command	Defined in SCPI 1999.0	Not Defined in SCPI 1999.0
[:SENSe] :ACPower :CSPacing		✓
:BANDwidth :ACHannel		✓
BWIDth :INTEgration		✓
:FILTer :COEFFicient		✓
:TYPE		✓
:ADEMod :BLOCK		✓
:CARRier :OFFSet		✓
:SEARCh		✓
:FM :THReshold		✓
[:IMMediate]		✓
:LENGth		✓
:MODulation		✓
:OFFSet		✓
:PM :THReshold		✓
:AVERage :CLEar		✓
:COUNT		✓
[:STATE]		✓
:TCONtrol		✓
:BSIZE		✓
:CCDF :BLOCK		✓
:CLEar		✓
:RMEasurement		✓
:THReshold		✓

Table E-15: SCPI conformance information — :SENSe commands (Cont.)

Command	Defined in SCPI 1999.0	Not Defined in SCPI 1999.0
:CFrequency :CRESolution		✓
:CHPower :BANDwidth :INTEgration BWIDth		✓
:FILTer :COEFFicient		✓
:TYPE		✓
:CNRatio :BANDwidth :INTEgration BWIDth		✓
:NOISE		✓
:FILTer :COEFFicient		✓
:TYPE		✓
:OFFSet		✓
:CORRection :DATA		✓
:DELeTe		✓
:OFFSet [:MAGNitude]		✓
:FREQUency		✓
[:STATE]		✓
:X :SPACing		✓
:Y :SPACing		✓
:DDEMod :BLOCK		✓
:CARRier :OFFSet		✓
:SEARCh		✓
:FILTer :ALPHa		✓
:MEASurement		✓
:REFerence		✓
:FORMat		✓
[:IMMEDIATE]		✓
:LENGth		✓
:NLINearity :COEFFicient		✓
:HDIVision		✓
:LSRegion [:SET]		✓
:UNIT		✓
:OFFSet		✓

Table E-15: SCPI conformance information — :SENSE commands (Cont.)

Command	Defined in SCPI 1999.0	Not Defined in SCPI 1999.0
:PRESet		✓
:SRATe		✓
:EBWidth :XDB		✓
:FEED		✓
:FREQuency :BAND		✓
:CENTer :STEP :AUTO [:INCRement]		✓
:CHANnel		✓
:CTABle :CATalog [:SElect]		✓
:SPAN		✓
:STARt		✓
:STOP		✓
:OBWidth :PERCent		✓
:PULSe :BLOCK :CHPower :BANDwidth BWIDth :INTEgration		✓
:CRESolution		✓
:EBWidth :XDB		✓
:FILTer :COEFFicient		✓
:MEASurement		✓
:BANDwidth BWIDth		✓
[:IMMediate]		✓
:OBWidth :PERCent		✓
:PTOffset		✓
:THReshold		✓
:ROSCillator :SOURce		✓
:SPECTrum :AVERage :CLEar		✓
:COUNT		✓
[:STATe]		✓
:TYPE		✓
:BANDwidth BWIDth [:RESolution]		✓
:AUTO		✓
:STATe		✓

Table E-15: SCPI conformance information — :SENSE commands (Cont.)

Command		Defined in SCPI 1999.0	Not Defined in SCPI 1999.0
	:DETECTOR [:FUNCTION]		✓
	:FILTER :COEFFICIENT		✓
	:TYPE		✓
	:FFT :ERESOLUTION		✓
	:LENGTH		✓
	:START		✓
	:WINDOW [:TYPE]		✓
	:FRAME		✓
	:MEASUREMENT		✓
:SPURIOUS [:THRESHOLD]	:EXCURSION		✓
	:IGNORE		✓
	:SIGNAL		✓
	:SPURIOUS		✓
	:MEASUREMENT		✓
:TRANSIENT	:BLOCK		✓
	[:IMMEDIATE]		✓
	:ITEM		✓
	:LENGTH		✓
	:OFFSET		✓

Table E-16: SCPI conformance information — :STATus commands

Command			Defined in SCPI 1999.0	Not Defined in SCPI 1999.0
:STATus	:OPERation	:CONDition?	✓	
		:ENABle	✓	
		[:EVENT]?	✓	
		NTRansition	✓	
		PTRansition	✓	
	:PRESet		✓	
	:QUESTionable	:CONDition?	✓	
		:ENABle	✓	
		[:EVENT]?	✓	
		NTRansition	✓	
		PTRansition	✓	

Table E-17: SCPI conformance information — :SYSTem commands

Command			Defined in SCPI 1999.0	Not Defined in SCPI 1999.0	
:SYSTem	:DATE		✓		
	:ERRor	:ALL?	✓		
		:CODE	:ALL?	✓	
			[:NEXT]?	✓	
		:COUNT?	✓		
		[:NEXT]?	✓		
	:KLOCK		✓		
	:OPTions?			✓	
	:PRESet		✓		
	:TIME		✓		
	:VERSion?		✓		

Table E-18: SCPI conformance information — :TRACe commands

Command	Defined in SCPI 1999.0	Not Defined in SCPI 1999.0
:TRACe<x> :MODE		✓
:DDETECTOR		✓
:AVERage :CLEAr		✓
:COUNT		✓

Table E-19: SCPI conformance information — :TRIGger commands

Command	Defined in SCPI 1999.0	Not Defined in SCPI 1999.0
:TRIGger [:SEQuence] :LEVe1 :IF		✓
:IQFREquency		✓
:IQTIme		✓
:MODE	✓	
:MPOStion		✓
:OPOStion		✓
:POStion	✓	
:SLOPe	✓	
:SOURce	✓	

Table E-20: SCPI conformance information — :UNIT commands

Command	Defined in SCPI 1999.0	Not Defined in SCPI 1999.0
:UNIT :ANGLE	✓	

Glossary and Index

Glossary

AM (Amplitude Modulation)

The process, or result of a process, in which the amplitude of a sine wave (the carrier) is varied in accordance with the instantaneous voltage of a second electrical signal (the modulating signal).

ASCII

Acronym for the American Standard Code for Information Interchange. Controllers transmit commands to the analyzer using ASCII character encoding.

Backus-Naur Form (BNF)

A standard notation system for command syntax diagrams. The syntax diagrams in this manual use BNF notation.

Controller

A computer or other device that sends commands to and accepts responses from the analyzer.

EVM (Error Vector Magnitude)

The magnitude of an error of an actual signal relative to an ideal signal in a constellation display.

FM (Frequency Modulation)

The process, or result of a process, in which the frequency of an electrical signal (the carrier) is varied in accordance with some characteristic of a second electrical signal (the modulating signal or modulation).

GPIB

Acronym for General Purpose Interface Bus, the common name for the communications interface system defined in IEEE Std 488.

IEEE

Acronym for the Institute for Electrical and Electronic Engineers.

PM (Pulse Modulation)

The process, or result of a process, in which the amplitude, phase, or duration of a pulse train (the carrier) is varied in accordance with some characteristic of a second electrical signal (the modulating signal or modulation).

Index

A

Abbreviations, commands, queries, and parameters, 2–6

:ABORt command group, 2–15

:ABORt commands, 2–45

:ABORt, 2–46

Arguments, parameters, 2–4

B

Backus-Naur Form, 2–1

BNF (Backus-Naur form), 2–1

C

*CAL?, 2–36

:CALCulate command group, 2–16

:CALCulate commands, 2–47

:CALCulate<x>:DLINe<y>(?), 2–49

:CALCulate<x>:DLINe<y>:STATe(?), 2–49

:CALCulate<x>:MARKer<y>:AOFF, 2–50

:CALCulate<x>:MARKer<y>:MAXimum, 2–50

:CALCulate<x>:MARKer<y>:MODE(?), 2–51

:CALCulate<x>:MARKer<y>:PEAK:HIGHer, 2–51

:CALCulate<x>:MARKer<y>:PEAK:LEFT, 2–52

:CALCulate<x>:MARKer<y>:PEAK:LOWer, 2–52

:CALCulate<x>:MARKer<y>:PEAK:RIGHT, 2–53

:CALCulate<x>:MARKer<y>:PTHReshold(?), 2–53

:CALCulate<x>:MARKer<y>:ROFF, 2–54

:CALCulate<x>:MARKer<y>:T(?), 2–57

:CALCulate<x>:MARKer<y>:TOGGle, 2–57

:CALCulate<x>:MARKer<y>:TRACe(?), 2–58

:CALCulate<x>:MARKer<y>:X(?), 2–59

:CALCulate<x>:MARKer<y>:Y(?), 2–60

:CALCulate<x>:MARKer<y>[:SET]:CENTer, 2–54

:CALCulate<x>:MARKer<y>[:SET]:MEASurement, 2–55

:CALCulate<x>:MARKer<y>[:SET]:RCURsor, 2–56

:CALCulate<x>:MARKer<y>[:STATe](?), 2–56

:CALCulate<x>:VLINe<y>(?), 2–61

:CALCulate<x>:VLINe<y>:STATe(?), 2–61

:CALibration command group, 2–17

:CALibration commands, 2–63

:CALibration:AUTO(?), 2–65

:CALibration:DATA:DEFault, 2–65

:CALibration:OFFSet:BASebanddc(?), 2–66

:CALibration:OFFSet:CENTer(?), 2–67

:CALibration:OFFSet:IQINput(?), 2–68

:CALibration:RF(?), 2–69

:CALibration[:ALL](?), 2–64

Case sensitivity, 2–9

Character chart, A–1

*CLS, 2–37

Command group

:ABORt, 2–15

:CALCulate, 2–16

:CALibration, 2–17

:CONFIgure, 2–17

:DISPlay, 2–18

:FETCh, 2–22

:FORMat, 2–23

:HCOPY, 2–23

IEEE common, 2–15

:INITiate, 2–24

:INPut, 2–24

:INSTrument, 2–24

:MMEMory, 2–25

:PROGram, 2–25

:READ, 2–26

:SENSe, 2–27

:STATus, 2–31

:SYSTem, 2–31

:TRACe, 2–32

:TRIGger, 2–32

:UNIT, 2–32

Commands

chaining, 2–7

rules for forming, 2–1

structure of IEEE 488.2 commands, 2–10

syntax, 2–1

:CONFIgure command group, 2–17

:CONFIgure commands, 2–71

:CONFIgure:ADEMod:AM, 2–72

:CONFIgure:ADEMod:FM, 2–72

:CONFIgure:ADEMod:PM, 2–73

:CONFIgure:CCDF, 2–73

:CONFIgure:DDEMod, 2–74

:CONFIgure:OVIEw, 2–74

:CONFIgure:PULSe, 2–75

:CONFIgure:SPECTrum, 2–75

:CONFIgure:SPECTrum:ACPower, 2–76

:CONFIgure:SPECTrum:CFRrequency, 2–76

:CONFIgure:SPECTrum:CHPower, 2–77

:CONFIgure:SPECTrum:CNRatio, 2–77

:CONFIgure:SPECTrum:EBWidth, 2–78

- :CONFigure:SPEctrum:OBWidth, 2–78
 - :CONFigure:SPEctrum:SPURious, 2–79
 - :CONFigure:TFRequency:RTIME, 2–79
 - :CONFigure:TFRequency:SGRam, 2–80
 - :CONFigure:TRANsient:FVTime, 2–80
 - :CONFigure:TRANsient:IQVTime, 2–81
 - :CONFigure:TRANsient:PVTime, 2–81
 - Conformance information, E–1
 - Creating commands, 2–3
- D**
- Difference between RSA3303A and RSA3308A, ix
 - :DISPlay command group, 2–18
 - :DISPlay commands, 2–83
 - :DISPlay:CCDF:LINE:GAUSSian[:STATe](?), 2–87
 - :DISPlay:CCDF:LINE:REFeRence:STORe, 2–88
 - :DISPlay:CCDF:LINE:REFeRence[:STATe](?), 2–87
 - :DISPlay:CCDF:X[:SCALe]:AUTO(?), 2–88
 - :DISPlay:CCDF:X[:SCALe]:MAXimum(?), 2–89
 - :DISPlay:CCDF:X[:SCALe]:OFFSet(?), 2–89
 - :DISPlay:CCDF:Y[:SCALe]:FIT, 2–90
 - :DISPlay:CCDF:Y[:SCALe]:FULL, 2–90
 - :DISPlay:CCDF:Y[:SCALe]:MAXimum(?), 2–91
 - :DISPlay:CCDF:Y[:SCALe]:MINimum(?), 2–91
 - :DISPlay:OVIEW:FORMat(?), 2–123
 - :DISPlay:OVIEW:OTINdicator(?), 2–123
 - :DISPlay:OVIEW:SGRam:COLor[:SCALe]:OFFSet(?), 2–124
 - :DISPlay:OVIEW:SGRam:COLor[:SCALe]:RANGe(?), 2–124
 - :DISPlay:OVIEW:SGRam:X[:SCALe]:OFFSet(?), 2–125
 - :DISPlay:OVIEW:SGRam:X[:SCALe]:SPAN(?), 2–125
 - :DISPlay:OVIEW:SGRam:Y[:SCALe]:OFFSet(?), 2–126
 - :DISPlay:OVIEW:SGRam:Y[:SCALe]:PLINe(?), 2–126
 - :DISPlay:OVIEW:WAVEform:X[:SCALe]:OFFSet(?), 2–127
 - :DISPlay:OVIEW:WAVEform:X[:SCALe]:PDIVision(?), 2–127
 - :DISPlay:OVIEW:WAVEform:Y[:SCALe]:FIT, 2–128
 - :DISPlay:OVIEW:WAVEform:Y[:SCALe]:FULL, 2–128
 - :DISPlay:OVIEW:WAVEform:Y[:SCALe]:OFFSet(?), 2–129
 - :DISPlay:OVIEW:WAVEform:Y[:SCALe]:PDIVision(?), 2–129
 - :DISPlay:PULSe:MVIew:RESult:CHPower(?), 2–131
 - :DISPlay:PULSe:MVIew:RESult:DCYClE(?), 2–131
 - :DISPlay:PULSe:MVIew:RESult:EBWidth(?), 2–132
 - :DISPlay:PULSe:MVIew:RESult:FREquency(?), 2–132
 - :DISPlay:PULSe:MVIew:RESult:OBWidth(?), 2–133
 - :DISPlay:PULSe:MVIew:RESult:OORatio(?), 2–133
 - :DISPlay:PULSe:MVIew:RESult:PERiod(?), 2–134
 - :DISPlay:PULSe:MVIew:RESult:PHASe(?), 2–134
 - :DISPlay:PULSe:MVIew:RESult:PPOWer(?), 2–135
 - :DISPlay:PULSe:MVIew:RESult:RIPPlE(?), 2–135
 - :DISPlay:PULSe:MVIew:RESult:WIDTh(?), 2–136
 - :DISPlay:PULSe:SPEctrum:X[:SCALe]:OFFSet(?), 2–142
 - :DISPlay:PULSe:SPEctrum:X[:SCALe]:PDIVision(?), 2–142
 - :DISPlay:PULSe:SPEctrum:Y[:SCALe]:FIT, 2–143
 - :DISPlay:PULSe:SPEctrum:Y[:SCALe]:FULL, 2–143
 - :DISPlay:PULSe:SPEctrum:Y[:SCALe]:OFFSet(?), 2–144
 - :DISPlay:PULSe:SPEctrum:Y[:SCALe]:PDIVision(?), 2–144
 - :DISPlay:PULSe:SVIEW:FORMat(?), 2–137
 - :DISPlay:PULSe:SVIEW:GUIDelines(?), 2–138
 - :DISPlay:PULSe:SVIEW:RANGe(?), 2–138
 - :DISPlay:PULSe:SVIEW:SElect(?), 2–139
 - :DISPlay:PULSe:SVIEW:SElect:RESult(?), 2–139
 - :DISPlay:PULSe:WAVEform:X[:SCALe]:OFFSet(?), 2–146
 - :DISPlay:PULSe:WAVEform:X[:SCALe]:PDIVision(?), 2–146
 - :DISPlay:PULSe:WAVEform:Y[:SCALe]:FIT, 2–147
 - :DISPlay:PULSe:WAVEform:Y[:SCALe]:FULL, 2–147
 - :DISPlay:PULSe:WAVEform:Y[:SCALe]:OFFSet(?), 2–148
 - :DISPlay:PULSe:WAVEform:Y[:SCALe]:PDIVision(?), 2–148
 - :DISPlay:SPEctrum:BMARker:STATe(?), 2–151
 - :DISPlay:SPEctrum:GRATicule:GRID(?), 2–151
 - :DISPlay:SPEctrum:MLINe:AMPLitude:INTerval(?), 2–152
 - :DISPlay:SPEctrum:MLINe:AMPLitude:OFFSet(?), 2–152
 - :DISPlay:SPEctrum:MLINe:AMPLitude[:STATe](?), 2–153
 - :DISPlay:SPEctrum:MLINe:ANNotation[:STATe](?), 2–153
 - :DISPlay:SPEctrum:MLINe:FREquency:INTerval(?), 2–154

- :DISPlay:SPEctrum:MLINe:FREQuency:OFFSet(?), 2–154
- :DISPlay:SPEctrum:MLINe:FREQuency[:STATe](?), 2–155
- :DISPlay:SPEctrum:X[:SCALe]:OFFSet(?), 2–156
- :DISPlay:SPEctrum:X[:SCALe]:PDIVision(?), 2–156
- :DISPlay:SPEctrum:Y[:SCALe]:FIT, 2–157
- :DISPlay:SPEctrum:Y[:SCALe]:FULL, 2–157
- :DISPlay:SPEctrum:Y[:SCALe]:OFFSet(?), 2–158
- :DISPlay:SPEctrum:Y[:SCALe]:PDIVision(?), 2–158
- :DISPlay:TFRequency:SGRam:COLor[:SCALe]:OFFSet(?), 2–161
- :DISPlay:TFRequency:SGRam:COLor[:SCALe]:RANGe(?), 2–161
- :DISPlay:TFRequency:SGRam:MLINe:ANNOtation[:STATe](?), 2–162
- :DISPlay:TFRequency:SGRam:MLINe:FREQuency:INTErval(?), 2–162
- :DISPlay:TFRequency:SGRam:MLINe:FREQuency:OFFSet(?), 2–163
- :DISPlay:TFRequency:SGRam:MLINe:FREQuency[:STATe](?), 2–163
- :DISPlay:TFRequency:SGRam:MLINe:TIME:INTErval(?), 2–164
- :DISPlay:TFRequency:SGRam:MLINe:TIME:OFFSet(?), 2–164
- :DISPlay:TFRequency:SGRam:MLINe:TIME[:STATe](?), 2–165
- :DISPlay:TFRequency:SGRam:X[:SCALe]:OFFSet(?), 2–166
- :DISPlay:TFRequency:SGRam:X[:SCALe]:SPAN(?), 2–166
- :DISPlay:TFRequency:SGRam:Y[:SCALe]:OFFSet(?), 2–167
- :DISPlay:TFRequency:SGRam:Y[:SCALe]:PLINe(?), 2–167
- :DISPlay:WAVEform:X[:SCALe]:OFFSet(?), 2–172
- :DISPlay:WAVEform:X[:SCALe]:PDIVision(?), 2–172
- :DISPlay:WAVEform:Y[:SCALe]:FIT, 2–173
- :DISPlay:WAVEform:Y[:SCALe]:FULL, 2–173
- :DISPlay:WAVEform:Y[:SCALe]:OFFSet(?), 2–174
- :DISPlay:WAVEform:Y[:SCALe]:PDIVision(?), 2–174
- :DISPlay[:VIEW]:BRIGHtneSS(?), 2–169
- :DISPlay[:VIEW]:FORMAt(?), 2–169
- :DISPlay commands for Option 21
- :DISPlay:DDEMod:CCDF:LINE:GAUSSian[:STATe](?), 2–95
- :DISPlay:DDEMod:MVIew:DStArt(?), 2–96
- :DISPlay:DDEMod:MVIew:FORMAt(?), 2–96
- :DISPlay:DDEMod:MVIew:HSSHift(?), 2–98
- :DISPlay:DDEMod:MVIew:RADix(?), 2–99
- :DISPlay:DDEMod:MVIew:X[:SCALe]:OFFSet(?), 2–100
- :DISPlay:DDEMod:MVIew:X[:SCALe]:RANGe(?), 2–101
- :DISPlay:DDEMod:MVIew:Y[:SCALe]:FIT, 2–102
- :DISPlay:DDEMod:MVIew:Y[:SCALe]:FULL, 2–102
- :DISPlay:DDEMod:MVIew:Y[:SCALe]:MAXimum(?), 2–103
- :DISPlay:DDEMod:MVIew:Y[:SCALe]:MINimum(?), 2–104
- :DISPlay:DDEMod:MVIew:Y[:SCALe]:OFFSet(?), 2–105
- :DISPlay:DDEMod:MVIew:Y[:SCALe]:RANGe(?), 2–106
- :DISPlay:DDEMod:NLINearity:LINE:BFIT[:STATe](?), 2–107
- :DISPlay:DDEMod:NLINearity:LINE:REFerence[:STATe](?), 2–108
- :DISPlay:DDEMod:NLINearity:MASK[:STATe](?), 2–109
- :DISPlay:DDEMod:SVIew:DStArt(?), 2–110
- :DISPlay:DDEMod:SVIew:FORMAt(?), 2–110
- :DISPlay:DDEMod:SVIew:HSSHift(?), 2–112
- :DISPlay:DDEMod:SVIew:RADix(?), 2–113
- :DISPlay:DDEMod:SVIew:X[:SCALe]:OFFSet(?), 2–114
- :DISPlay:DDEMod:SVIew:X[:SCALe]:RANGe(?), 2–115
- :DISPlay:DDEMod:SVIew:Y[:SCALe]:FIT, 2–116
- :DISPlay:DDEMod:SVIew:Y[:SCALe]:FULL, 2–116
- :DISPlay:DDEMod:SVIew:Y[:SCALe]:MAXimum(?), 2–117
- :DISPlay:DDEMod:SVIew:Y[:SCALe]:MINimum(?), 2–118
- :DISPlay:DDEMod:SVIew:Y[:SCALe]:OFFSet(?), 2–119
- :DISPlay:DDEMod:SVIew:Y[:SCALe]:RANGe(?), 2–120
- :DISPlay:CCDF subgroup, 2–86
- :DISPlay:DDEMod subgroup, 2–92
- :DISPlay:OVIew subgroup, 2–121
- :DISPlay:PULSe:MVIew[:SVIew] subgroup, 2–130
- :DISPlay:PULSe:SPEctrum subgroup, 2–140
- :DISPlay:PULSe:WAVEform subgroup, 2–145
- :DISPlay:SPEctrum subgroup, 2–149
- :DISPlay:TFRequency subgroup, 2–159
- :DISPlay:WAVEform subgroup, 2–171

:DISPlay[:VIEW] subgroup, 2–168

E

Error codes, 3–17
 commands, 3–18
 device specific, 3–22
 execution, 3–20
 hardware, 3–22
 query, 3–22
 *ESE(?), 2–37
 *ESR?, 2–38
 Example, programming, 4–1

F

:FETCh command group, 2–22
 :FETCh commands, 2–175
 :FETCh:ADEMod:AM?, 2–177
 :FETCh:ADEMod:AM:RESult?, 2–178
 :FETCh:ADEMod:FM?, 2–179
 :FETCh:ADEMod:FM:RESult?, 2–180
 :FETCh:ADEMod:PM?, 2–181
 :FETCh:CCDF?, 2–182
 :FETCh:DDEMod? (Option 21 Only), 2–183
 :FETCh:DISTriBution:CCDF?, 2–188
 :FETCh:OVIew?, 2–189
 :FETCh:PULSe?, 2–190
 :FETCh:PULSe:SPEctrum?, 2–194
 :FETCh:PULSe:TAMplitude?, 2–195
 :FETCh:PULSe:TFRrequency?, 2–196
 :FETCh:SPEctrum?, 2–197
 :FETCh:SPEctrum:ACPower?, 2–198
 :FETCh:SPEctrum:CFRrequency?, 2–199
 :FETCh:SPEctrum:CHPower?, 2–199
 :FETCh:SPEctrum:CNRatio?, 2–200
 :FETCh:SPEctrum:EBWidth?, 2–201
 :FETCh:SPEctrum:OBWidth?, 2–201
 :FETCh:SPEctrum:SPURious?, 2–202
 :FETCh:TRANSient:FVTime?, 2–203
 :FETCh:TRANSient:IQVTime?, 2–204
 :FETCh:TRANSient:PVTime?, 2–205
 :FORMat command group, 2–23
 :FORMat commands, 2–207
 :FORMat:BORDER(?), 2–208
 :FORMat[:DATA](?), 2–208

G

GPIB
 configurations, 1–5

connection rules, 1–5
 interface specification, B–1
 setting GPIB parameters, 1–6

H

:HCOPy command group, 2–23
 :HCOPy commands, 2–209
 :HCOPy:BACKground(?), 2–210
 :HCOPy:DESTination(?), 2–210
 :HCOPy[:IMMEDIATE], 2–211
 Hierarchy tree, 2–2

I

*IDN?, 2–39
 IEEE 488.2 Common Commands, 2–10
 IEEE common command group, 2–15
 IEEE common commands, 2–35
 *CAL?, 2–36
 *CLS, 2–37
 *ESE(?), 2–37
 *ESR?, 2–38
 *IDN?, 2–39
 *OPC(?), 2–39
 *OPT?, 2–40
 *RST, 2–41
 *SRE(?), 2–42
 *STB?, 2–43
 *TRG, 2–43
 *TST?, 2–44
 *WAI, 2–44
 IEEE Std 488.2-1987, 2–1
 Initialization settings, C–1
 :INITiate command group, 2–24
 :INITiate commands, 2–213
 :INITiate:REStart, 2–215
 :INITiate:CONTinuous(?), 2–214
 :INITiate[:IMMEDIATE], 2–215
 :INPut command group, 2–24
 :INPut commands, 2–217
 :INPut:ALEVel, 2–218
 :INPut:ATTenuation(?), 2–218
 :INPut:ATTenuation:AUTO(?), 2–219
 :INPut:COUpling(?), 2–220
 :INPut:MIXer(?), 2–221
 :INPut:MLEVel(?), 2–222
 :INSTrument command group, 2–24
 :INSTrument commands, 2–223
 :INSTrument:CATalog?, 2–224
 :INSTrument[:SElect](?), 2–225

Interface message, B-3

M

Measurement modes, 2-13, 2-224
 :MMEMory command group, 2-25
 :MMEMory commands, 2-227
 :MMEMory:COpy, 2-228
 :MMEMory:DELEte, 2-228
 :MMEMory:LOAD:CORREction, 2-229
 :MMEMory:LOAD:IQT, 2-229
 :MMEMory:LOAD:STATe, 2-230
 :MMEMory:LOAD:TRACe, 2-230
 :MMEMory:NAME(?), 2-231
 :MMEMory:STORE:CORREction, 2-231
 :MMEMory:STORE:IQT, 2-232
 :MMEMory:STORE:PULSe, 2-232
 :MMEMory:STORE:STABLE, 2-233
 :MMEMory:STORE:STATe, 2-234
 :MMEMory:STORE:TRACe, 2-234
 Mnemonics, Constructed, 2-11
 Mode, measurement, 2-13, 2-224

O

*OPC(?), 2-39
 *OPT?, 2-40

P

Parameter Types Used in Syntax Descriptions, 2-4
 :PROGram command group, 2-25
 :PROGram commands, 2-235
 :PROGram:CATalog?, 2-236
 :PROGram:NUMBer(?), 2-238
 :PROGram:STRing(?), 2-239
 :PROGram[SELEcted]:DELEte[SELEcted], 2-236
 :PROGram[SELEcted]:EXECute, 2-237
 :PROGram[SELEcted]:NAME(?), 2-237
 Programming example, 4-1

Q

Queries, 2-3
 Query Responses, 2-3
 Queues
 event, 3-12
 output, 3-12
 Quotes, 2-9

R

:READ command group, 2-26
 :READ commands, 2-241
 :READ:ADEMod:AM?, 2-243
 :READ:ADEMod:AM:RESult?, 2-244
 :READ:ADEMod:FM?, 2-245
 :READ:ADEMod:FM:RESult?, 2-246
 :READ:ADEMod:PM?, 2-247
 :READ:CCDF?, 2-248
 :READ:DDEMod? (Option 21 Only), 2-249
 :READ:DISTRibution:CCDF?, 2-254
 :READ:OVlew?, 2-255
 :READ:PULSe?, 2-256
 :READ:PULSe:SPECtrum?, 2-260
 :READ:PULSe:TAMplitude?, 2-261
 :READ:PULSe:TFrequency?, 2-262
 :READ:SPECtrum?, 2-263
 :READ:SPECtrum:ACPower?, 2-264
 :READ:SPECtrum:CFrequency?, 2-265
 :READ:SPECtrum:CHPower?, 2-265
 :READ:SPECtrum:CNRatio?, 2-266
 :READ:SPECtrum:EBWidth?, 2-267
 :READ:SPECtrum:OBWidth?, 2-267
 :READ:SPECtrum:SPURious?, 2-268
 :READ:TRANsient:FVTime?, 2-269
 :READ:TRANsient:IQVTime?, 2-270
 :READ:TRANsient:PVTime?, 2-271

Registers

Event Status Enable Register (ESER), 3-9
 Operation Condition Register (OCR), 3-8
 Operation Event Register (OEVR), 3-8
 Service Request Enable Register (SRER), 3-10
 Standard Event Status Register (SESR), 3-7
 Status Byte Register (SRB), 3-6

Retrieving response message, 2-401

*RST, 2-41

Rules

command forming, 2-1
 for using SCPI commands, 2-9

S

SCPI

abbreviating, 2-6
 chaining commands, 2-7
 commands, 2-2
 conformance information, E-1
 general rules, 2-9
 parameter types, 2-4

- subsystem hierarchy tree, 2–2
- SCPI commands and queries syntax, 2–2
 - creating commands, 2–3
 - creating queries, 2–3
- :SENSe command group, 2–27
- :SENSe commands, 2–273
 - [[:SENSe]:ACPower:BANDwidth|:BWIDTH:ACHannel(?), 2–275
 - [[:SENSe]:ACPower:BANDwidth|:BWIDTH:INTEgration(?), 2–275
 - [[:SENSe]:ACPower:CSPacing(?), 2–276
 - [[:SENSe]:ACPower:FILTer:COEFFicient(?), 2–277
 - [[:SENSe]:ACPower:FILTer:TYPE(?), 2–277
 - [[:SENSe]:ADEMod:BLOCK(?), 2–279
 - [[:SENSe]:ADEMod:CARRIER:OFFSet(?), 2–279
 - [[:SENSe]:ADEMod:CARRIER:SEARCh(?), 2–280
 - [[:SENSe]:ADEMod:FM:THREShold(?), 2–280
 - [[:SENSe]:ADEMod:LENGTh(?), 2–281
 - [[:SENSe]:ADEMod:MODulation(?), 2–282
 - [[:SENSe]:ADEMod:OFFSet(?), 2–283
 - [[:SENSe]:ADEMod:PM:THREShold(?), 2–283
 - [[:SENSe]:ADEMod[:IMMEDIATE], 2–281
 - [[:SENSe]:AVERage:CLEAR, 2–285
 - [[:SENSe]:AVERage:COUNt(?), 2–285
 - [[:SENSe]:AVERage:TCONtrol(?), 2–286
 - [[:SENSe]:AVERage[:STATe](?), 2–286
 - [[:SENSe]:BSIZE(?), 2–287
 - [[:SENSe]:CCDF:BLOCK(?), 2–289
 - [[:SENSe]:CCDF:CLEAR, 2–289
 - [[:SENSe]:CCDF:RMEASurement, 2–290
 - [[:SENSe]:CCDF:THREShold(?), 2–290
 - [[:SENSe]:CFREquency:CRESolution(?), 2–291
 - [[:SENSe]:CHPower:BANDwidth|:BWIDTH:INTEgration(?), 2–293
 - [[:SENSe]:CHPower:FILTer:COEFFicient(?), 2–294
 - [[:SENSe]:CHPower:FILTer:TYPE(?), 2–294
 - [[:SENSe]:CNRatio:BANDwidth|:BWIDTH:INTEgration(?), 2–296
 - [[:SENSe]:CNRatio:BANDwidth|:BWIDTH:NOISE(?), 2–297
 - [[:SENSe]:CNRatio:FILTer:COEFFicient(?), 2–298
 - [[:SENSe]:CNRatio:FILTer:TYPE(?), 2–298
 - [[:SENSe]:CNRatio:OFFSet(?), 2–299
 - [[:SENSe]:CORRection:DATA(?), 2–301
 - [[:SENSe]:CORRection:DELeTe, 2–301
 - [[:SENSe]:CORRection:OFFSet:FREQuency(?), 2–302
 - [[:SENSe]:CORRection:OFFSet[:MAGNitude](?), 2–302
 - [[:SENSe]:CORRection:X:SPACing(?), 2–304
 - [[:SENSe]:CORRection:Y:SPACing(?), 2–304
 - [[:SENSe]:CORRection[:STATe](?), 2–303
 - [[:SENSe]:EBWidth:XDB(?), 2–325
 - [[:SENSe]:FEED, 2–326
 - [[:SENSe]:FREQuency:BAND?, 2–328
 - [[:SENSe]:FREQuency:CENTer(?), 2–329
 - [[:SENSe]:FREQuency:CENTer:STEP:AUTO(?), 2–330
 - [[:SENSe]:FREQuency:CENTer:STEP[:INCRement](?), 2–331
 - [[:SENSe]:FREQuency:CHANnel(?), 2–332
 - [[:SENSe]:FREQuency:CTABle:CATALog?, 2–332
 - [[:SENSe]:FREQuency:CTABle[:SELect](?), 2–333
 - [[:SENSe]:FREQuency:SPAN(?), 2–334
 - [[:SENSe]:FREQuency:STARt(?), 2–335
 - [[:SENSe]:FREQuency:STOP(?), 2–335
 - [[:SENSe]:OBWidth:PERCent(?), 2–337
 - [[:SENSe]:PULSe:BLOCK(?), 2–339
 - [[:SENSe]:PULSe:CHPower:BANDwidth|:BWIDTH:INTEgration(?), 2–339
 - [[:SENSe]:PULSe:CRESolution(?), 2–340
 - [[:SENSe]:PULSe:EBWidth:XDB(?), 2–340
 - [[:SENSe]:PULSe:FFT:COEFFicient(?), 2–341
 - [[:SENSe]:PULSe:FFT:WINDow[:TYPE](?), 2–341
 - [[:SENSe]:PULSe:FILTer:BANDwidth|BWIDTH(?), 2–342
 - [[:SENSe]:PULSe:FILTer:COEFFicient(?), 2–342
 - [[:SENSe]:PULSe:FREQuency:OFFSet(?), 2–343
 - [[:SENSe]:PULSe:FREQuency:RECOVery(?), 2–344
 - [[:SENSe]:PULSe:OBWidth:PERcent(?), 2–345
 - [[:SENSe]:PULSe:PTOFFset(?), 2–346
 - [[:SENSe]:PULSe:THREShold(?), 2–346
 - [[:SENSe]:PULSe[:IMMEDIATE], 2–345
 - [[:SENSe]:ROSCillator:SOURce(?), 2–347
 - [[:SENSe]:SPECTrum:AVERage:CLEAR, 2–349
 - [[:SENSe]:SPECTrum:AVERage:COUNt(?), 2–349
 - [[:SENSe]:SPECTrum:AVERage:TYPE(?), 2–350
 - [[:SENSe]:SPECTrum:AVERage[:STATe](?), 2–350
 - [[:SENSe]:SPECTrum:BANDwidth|BWIDTH:STATe(?), 2–352
 - [[:SENSe]:SPECTrum:BANDwidth|BWIDTH[:RESolution](?), 2–351
 - [[:SENSe]:SPECTrum:BANDwidth|BWIDTH[:RESolution]:AUTO(?), 2–351
 - [[:SENSe]:SPECTrum:DETEctor[:FUNction](?), 2–353
 - [[:SENSe]:SPECTrum:FFT:ERESolution(?), 2–355
 - [[:SENSe]:SPECTrum:FFT:LENGTh(?), 2–356
 - [[:SENSe]:SPECTrum:FFT:STARt(?), 2–356
 - [[:SENSe]:SPECTrum:FFT:WINDow[:TYPE](?), 2–357
 - [[:SENSe]:SPECTrum:FILTer:COEFFicient(?), 2–354
 - [[:SENSe]:SPECTrum:FILTer:TYPE(?), 2–354
 - [[:SENSe]:SPECTrum:FRAME(?), 2–358

- [:SENSe]:SPECtrum:MEASurement(?), 2–359
 - [:SENSe]:SPURious[:THReshold]:EXCursion(?), 2–361
 - [:SENSe]:SPURious[:THReshold]:IGNore(?), 2–362
 - [:SENSe]:SPURious[:THReshold]:SIGNal(?), 2–362
 - [:SENSe]:SPURious[:THReshold]:SPURious(?), 2–363
 - [:SENSe]:TRANsient:BLOCK(?), 2–365
 - [:SENSe]:TRANsient:ITEM(?), 2–366
 - [:SENSe]:TRANsient:LENGth(?), 2–366
 - [:SENSe]:TRANsient:OFFSet(?), 2–367
 - [:SENSe]:TRANsient[:IMMEDIATE], 2–365
 - :SENSe commands for Option 21
 - [:SENSe]:DDEMod:BLOCK(?), 2–307
 - [:SENSe]:DDEMod:CARRier:OFFSet(?), 2–307
 - [:SENSe]:DDEMod:CARRier:SEARch(?), 2–308
 - [:SENSe]:DDEMod:DECode(?), 2–309
 - [:SENSe]:DDEMod:FDEVIation(?), 2–310
 - [:SENSe]:DDEMod:FDEVIation:AUTO(?), 2–311
 - [:SENSe]:DDEMod:FILTer:ALPHa(?), 2–311
 - [:SENSe]:DDEMod:FILTer:MEASurement(?), 2–312
 - [:SENSe]:DDEMod:FILTer:REFerence(?), 2–312
 - [:SENSe]:DDEMod:FORMat(?), 2–313
 - [:SENSe]:DDEMod:LENGth(?), 2–315
 - [:SENSe]:DDEMod:MDEPth(?), 2–316
 - [:SENSe]:DDEMod:MDEPth:AUTO(?), 2–317
 - [:SENSe]:DDEMod:NLINearity:COEFFicient(?), 2–318
 - [:SENSe]:DDEMod:NLINearity:HDIVision(?), 2–318
 - [:SENSe]:DDEMod:NLINearity:LSRegion:UNIT(?), 2–320
 - [:SENSe]:DDEMod:NLINearity:LSRegion[:SET](?), 2–319
 - [:SENSe]:DDEMod:OFFSet(?), 2–321
 - [:SENSe]:DDEMod:PRESet(?), 2–322
 - [:SENSe]:DDEMod:SRATe(?), 2–323
 - [:SENSe]:DDEMod[:IMMEDIATE], 2–314
 - [:SENSe]:PULSe:FILTer:MEASurement(?), 2–343
 - [:SENSe]:ACPower subgroup, 2–274
 - [:SENSe]:ADEMod subgroup, 2–278
 - [:SENSe]:ADEMod:LENGth(?), 2–281
 - [:SENSe]:AVERage subgroup, 2–284
 - [:SENSe]:BSIZe subgroup, 2–287
 - [:SENSe]:CCDF subgroup, 2–288
 - [:SENSe]:CFRequency subgroup, 2–291
 - [:SENSe]:CHPower subgroup, 2–292
 - [:SENSe]:CNRatio subgroup, 2–295
 - [:SENSe]:CORRection subgroup, 2–300
 - [:SENSe]:DDEMod subgroup (Option 21 Only), 2–305
 - [:SENSe]:EBWidth subgroup, 2–324
 - [:SENSe]:FEED subgroup, 2–326
 - [:SENSe]:FREQuency subgroup, 2–327
 - [:SENSe]:OBWidth subgroup, 2–336
 - [:SENSe]:PULSe subgroup, 2–338
 - [:SENSe]:ROSCillator subgroup, 2–347
 - [:SENSe]:SPECtrum subgroup, 2–348
 - [:SENSe]:SPURious subgroup, 2–360
 - [:SENSe]:TRANsient subgroup, 2–364
 - Setting
 - range of RBW, D–2
 - range of scale, D–1
 - SI prefix and unit, 2–8
 - Special characters, 2–6
 - *SRE(?), 2–42
 - :STATus command group, 2–31
 - :STATus commands, 2–369
 - :STATus:OPERation:CONDition?, 2–370
 - :STATus:OPERation:ENABle(?), 2–370
 - :STATus:OPERation:NTRansition(?), 2–371
 - :STATus:OPERation:PTRansition(?), 2–372
 - :STATus:OPERation[:EVENT]?, 2–371
 - :STATus:PRESet, 2–372
 - :STATus:QUEStionable:CONDition?, 2–373
 - :STATus:QUEStionable:ENABle(?), 2–373
 - :STATus:QUEStionable:NTRansition(?), 2–374
 - :STATus:QUEStionable:PTRansition(?), 2–375
 - :STATus:QUEStionable[:EVENT]?, 2–374
 - *STB?, 2–43
 - Syntax, command, 2–1
 - :SYSTem command group, 2–31
 - :SYSTem commands, 2–377
 - :SYSTem:DATE(?), 2–378
 - :SYSTem:ERRor:ALL?, 2–379
 - :SYSTem:ERRor:CODE:ALL?, 2–380
 - :SYSTem:ERRor:CODE[:NEXT]?, 2–380
 - :SYSTem:ERRor:COUNt?, 2–381
 - :SYSTem:ERRor[:NEXT]?, 2–381
 - :SYSTem:KLOCK(?), 2–382
 - :SYSTem:OPTions?, 2–382
 - :SYSTem:PRESet, 2–383
 - :SYSTem:TIME(?), 2–383
 - :SYSTem:VERSion?, 2–384
- ## T
- TekVISA, 1–8
 - installing, 1–8
 - :TRACe command group, 2–32
 - :TRACe commands, 2–385
 - :TRACe<x>[:DATA<x>]:AVERage:CLEar, 2–386
 - :TRACe<x>[:DATA<x>]:AVERage:COUNt(?), 2–386

- :TRACe<x>|:DATA<x>:DDETEctor(?), 2–387
- :TRACe<x>|:DATA<x>:MODE(?), 2–388
- *TRG, 2–43
- :TRIGger command group, 2–32
- :TRIGger commands, 2–389
 - :TRIGger[:SEQuence]:LEVel:IF(?), 2–390
 - :TRIGger[:SEQuence]:LEVel:IQFREquency(?), 2–390
 - :TRIGger[:SEQuence]:LEVel:IQTime(?), 2–392
 - :TRIGger[:SEQuence]:MODE(?), 2–393
 - :TRIGger[:SEQuence]:MPOStion?, 2–394
 - :TRIGger[:SEQuence]:OPOStion?, 2–395
 - :TRIGger[:SEQuence]:POStion(?), 2–396
 - :TRIGger[:SEQuence]:SLOPe(?), 2–397

- :TRIGger[:SEQuence]:SOURce(?), 2–398
- *TST?, 2–44

U

- Unit and SI prefix, 2–8
- :UNIT command group, 2–32
- :UNIT commands, 2–399
 - :UNIT:ANGLe(?), 2–400

W

- *WAI, 2–44